

» The Profile System

English
1/2015

 MayTec®



Solutions with Innovative Profile

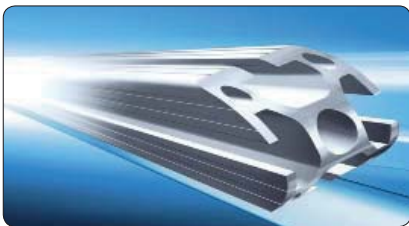

The Profile System



Curved Profiles



The Clean-Room System



The Telescopic System



The Linear System



The Conveyor System



The Personnel Transfer System



Safety Barriers



The Dust Protection System

The ideal profile system

MayTec offers a comprehensive, harmonised profile system. All profiles can be combined in any way conceivable.

The accessories provide functional and aesthetic solutions for a wide range of applications.

Applications

- machine bases
- machine enclosures
- machine guarding
- work stations

Service

The MayTec service is as versatile as the MayTec profile system.

You may choose:

- delivery of standard elements ex-factory
- delivery of profiles and accessories cut to size according to parts list for customer's assembly
- delivery of pre-fitted modular components
- delivery of completely assembled units
- assembly at your premises

- assembly and inspection stations
- transfer and supply trolleys
- partitions and protective walls
- protective and work cabins

Implementation

The MayTec profile system is easy to process and quick to assemble. Its flexible and modular construction means it can be easily modified and is reusable at any time.

An experienced team will support you in implementing the MayTec system, tailored to your individual applications, taking into consideration your dimensions, loading capacity and stability.

- special shelves
- plant equipment
- display systems
- exhibition cabinets and stands

Table of contents

Introduction	1.0
--------------	-----

Profiles
Summary

Profiles	1.1
Profile machining	1.1A
- Coding examples	1.1B
Technical data	1.1C
Profile selection range	1.1D
Profile applications	1.1E
- Curved profiles	1.1E

Connection system
Summary

Connector selection	1.2
Connectors	1.2A
- Cross bushings	1.2B
- Components	1.2C
- Special cases	1.2D
Connection possibilities	1.2E
Connector-Strength values	1.2F
Connection elements	1.29

Accessories
Summary

Fastening elements	1.3
Installation accessories	1.4
Pneumatic accessories	1.5
Additional accessories	1.6
Electrical accessories	1.7
Panel elements	1.8
Washers, screws and tools	1.9

Subject index
0
1
2
3
4
5
6
7
8
9

Article number group	Page	Article number group	Page	
1.41	Wedge profiles	1.61	161	
1.41	Sponge rubber round cords	1.62	162	
1.41	Sealing profile	1.64	164	
1.41	Rubber cover-profiles	1.68	168	
1.42	Cover caps for profiles	1.69	169	
1.42	Cover plugs for cross bushings	1.73	173	
1.42	Cover caps for tubes	1.74	174	
1.42	Cover caps for screw bores	1.74	174	
1.43	Radius covers	1.75	175	
1.43	Radius compensations	1.77	177	
1.44	Floor levelling screws	1.78	178	
1.44	Levelling feet	178, 180		
1.44	Hand adjustable feet	1.179	179	
1.44	Levelling furniture foot	1.180	180	
1.44	Adjustable tilt-feet	1.181	181	
1.44	plates	1.182	182	
1.44	spindles	1.184	184	
1.44	nuts	1.184	184	
1.44	anti-slip discs	1.185	185	
1.44	cushion elements	1.185	185	
1.44	Angular adjusting feet	1.186	186	
1.44	Base feet	1.187	187	
1.44	Base angle	1.193	193	
1.44	Stacking foot	1.193	193	
1.45	Castors	1.194	194	
1.45	Locking castors	1.196	196	
1.46	Angles	1.198	198	
1.46	Aluminium	1.198, 207		
1.46	PA	1.199	199	
1.46	GD-Zn	1.200	200	
1.46	GD-Al	1.206	206	
1.46	Swivel angles	1.208	208	
1.47	Cross connection plates	1.209	209	
1.47	Base plates	1.210	210	
1.47	Floor mounting plate	1.212	212	
1.47	Mounting plates	1.213	213	
1.47	Floor plate	1.213	213	
1.47	Connection plates	1.214	214	
1.47	Fastening plate	1.215	215	
1.47	Eye bolt	1.216	216	
1.48	Corner pieces	1.217	217	
1.48	GD-Zn	1.217	217	
1.48	Aluminium	1.219	219	
1.5	Pneumatic accessories	221		
1.51	Profiles for pneumatic applications	1.221	221	
1.51	Pneumatic end plates	1.222	222	
1.52	Pneumatic connection plates	1.227	227	
1.54	Pneumatic extension sets	1.228	228	
1.55	Pneumatic 90° - connection sets	1.229	229	
1.59	Pneumatic accessories	1.230	230	
1.6	Additional accessories	231		
1.61	Handles	1.231	231	
1.61	Handle systems	1.234	234	
1.61	Grab handles	1.236	236	
1.62	Hinges	1.237	237	
1.62	Double hinge	1.243	243	
1.63	Joints	1.253	253	
1.64	Mounting blocks	1.256	256	
1.64	Mounting clamp blocks	1.260	260	
1.64	Quick locks	1.263	263	
1.65	Bullet catches	1.265	265	
1.65	Magnetic lock	1.267	267	
1.65	Lock	1.268	268	
1.65	Cylinder locks	1.269	269	
1.65	Flap-lock countersunk	1.271	271	
1.65	Cylinder locks flush	1.271	271	
1.65	Mortise deadlocks	1.273	273	
1.65	Bar locks	1.277	277	
1.65	Latch locks	1.281	281	
1.66	Rollers	1.282	282	
1.66	Roller fastening sets	1.284	284	
1.66	Mounting adaptor for roller	1.288	288	
1.66	Edge roller	1.289	289	
1.66	Runner for sliding suspended doors	1.290	290	
1.66	Stopper for sliding suspended doors	1.291	291	
1.67	Slot rollers	1.292	292	
1.67	Guidance system	1.293	293	
1.67	Sliding blocks	1.294	294	
1.67	T-Nut sliding blocks	1.295	295	
1.67	Eco-Slides	1.296	296	
1.68	Hanging bracket	1.300	300	
1.69	Suspended glider	1.301	301	
1.69	Carabine swivel	1.301	301	
1.7	Electrical accessories	302		
1.70	Potential equalisation, grounding connectors	1.302	302	
1.70	Ground connections	1.303	303	
1.71	Cable and hose clamp	1.304	304	
1.71	(Cross-) blocks for cable binder, cable binder	1.305	305	
1.71	Installation rings	1.306	306	
1.72	Mounting set for 19" profile	1.307	307	
1.73	Safety switches	1.308	308	
1.73	Guard locking devices	1.309	309	
1.73	Safety interlocking-mountings	1.310	310	
1.73	Contact bracket-mounting	1.311, 314		
1.73	Sensor brackets	1.315	315	
1.75	Electrical installation trunking	1.316	316	
1.8	Panel elements	320		
1.81	Corner elements	1.320	320	
1.81	Corner element 33	1.321	321	
1.81	Mounting sockets	1.322	322	
1.82	Panel elements	1.323	323	
1.82	Chipboards, coated	1.324	324	
1.82	Solid plastic panels	1.324	324	
1.85	Alu-plastic composite panels	1.325	325	
1.86	Acrylic	1.325	325	
1.87	Polycarbonate (Makrolon)	1.326	326	
1.88	Wire net, Alu	1.326	326	
1.88	Wire net, steel	1.327	327	
1.88	Grid, steel	1.327	327	
1.9	Washers, screws and tools	328		
1.90	Self locking washers	1.328	328	
1.90	Button head screws	1.330	330	
1.98	Press in device	1.330	330	
1.98	Tx screw driver	1.330	330	
1.99	Summary: Tools for cross bushings and anchors	1.331	331	
1.99	Drill Jigs	1.332, 334		
1.99	Milling cutters	1.333, 335		
1.99	Drills	1.333, 335		
1.99	Tools: Special cases	1.336	336	
1.99	Screw taps	1.337	337	
			Subject index	339

General

Profile group

16 mm, 20 mm, 30 mm, 40 mm, 45 mm, 50 mm, 60 mm

The profiles of the MayTec Profile System are divided into seven **profile groups (PG)**. They can be determined by the basic measure of each profile.

Slot

H-slot, F-slot, E-slot

In order to connect the profiles or to mount accessories the profiles have slots. The MayTec Slot System (→ 1.02) distinguishes between the three slot types H-slot, F-slot and E-slot, whereas E-slot exists as **E3-slot** and **E4-slot** (3 or 4 mm wall thickness).

Symbols

Many articles (fastening elements, accessories and tools) can only be used especially for individual profile groups or slot types. In this case these articles are marked with the corresponding symbols.



Profile group

dark symbol: suitable for the corresponding profile group

light symbol: not suitable

Slot type

dark symbol: suitable for the corresponding slot type

light symbol: not suitable

Remark

The symbol for the E-slot is used, if the article is (un)suitable for the two slot types E3 and E4.



Cut

These articles are offered with cut.



Stainless steel

These articles are made of stainless steel.



Cleanroom

These articles are suitable for the use in and around cleanrooms.



Attention!

Important notice











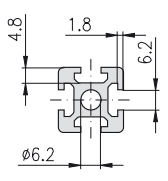



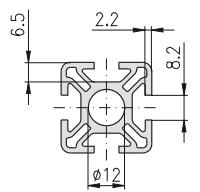

Abbreviations

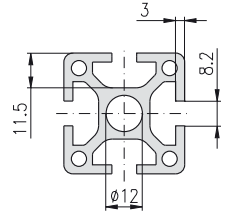
PG	profile group	e.g.: PG 30 = profile group 30 mm
L	light	profile characteristic: light type of construction
S	heavy	profile characteristic: heavy type of construction
P	plain	profile characteristic: no ornamental slots

Special characters

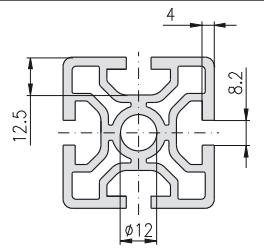
□	Placeholder Article-No.	Example 1.41.5□□.□	identifies the articles: 1.41.5F0.1 1.41.5F0.2 1.41.5E0.1 1.41.5E0.2
---	-----------------------------------	------------------------------	---

→	Example 117 1.41 1.41.710.2 1.41.5□□.□	Reference <i>to catalogue page</i> <i>to article number group</i> <i>to single article</i> <i>to group of articles</i>
---	---	---

Cross section of slots		Core hole-Ø	Slot width	Slot depth	Wall thickness	PG	
H-slot 	   	6.2	6.2	4.8	1.8	20	
F-slot 	   	12.0	8.2	6.5	2.2	20	
							30
E3-slot 	   	12.0	8.2	11.5	3.0	40	
E4-slot 	   	12.0	8.2	12.5	4.0	45	
							50
							60

Profiles

1. 1 □ . □□□□□□ . □□□□□□	Key
1. 1 □ . □□□□□□ . □□□□□□	Core hole-Ø ¹⁾
1. 1 □ . □□□□□□ . □□□□□□	Profile width
1. 1 □ . □□□□□□ . □□□□□□	Profile height (all, but special profiles)
1. 1 □ . □□□ R □□ . □□□□□□	Number of degrees (round profiles)
1. 1 □ . □□□□ k t . □□□□□□	Number of edges (special profiles)
1. 1 □ . □□□□□□ . □□□□□□	Slot quantity ²⁾
1. 1 □ . □□□□□□ . □□□□□□	Contour ³⁾
1. 1 □ . □□□□□□ . □□ L	Version light
1. 1 □ . □□□□□□ . □□ S	Version heavy
1. 1 □ . □□□□□□ . □□ B	Type B
1. 1 □ . □□□□□□ . □□ L B	Version light, Type B
1. 1 □ . □□□□□□ . □□ P	Plain

- ¹⁾ 0 = 6.2 mm
1 = 12 mm
- ²⁾ 2-digit off 10 slots
- ³⁾ 0 = round
1 = Soft
2 = Corner
3 = Cubic
4 = Rectangle
5 = Pneumatic
7 = Angle
8 = Angle 45°
9 = Special

Connectors

- general

1. 2 □ . □□□□□□	Key
1. 2 □ . □□□□□□	Core hole ¹⁾
1. 2 □ . □□□□□□	Profile width ²⁾
1. 2 □ . □□□□□□	Head-variant ³⁾
1. 2 □ . □□□□□□	Connection-variant ⁴⁾
1. 2 □ . □□□ V □□	Stainless
1. 2 □ . □□□□□ E	Ground
<div style="display: flex; align-items: center; justify-content: center;"> <div style="margin-right: 10px;"> □/□ □/□ □/□ </div> <div> Special cases: Parallel-connector across and high Profile width for cross bushing Profile width for anchor </div> </div>	

- ¹⁾ 0 = 6.2 mm
1 = 12 mm
- ²⁾ 2 = 20 mm
3 = 30 mm
4 = 40 mm
45 = 45 mm
5 = 50 mm
6 = 60 mm
- ³⁾ E = E-head
F = F-head
H = H-head
V = Extension
- ⁴⁾ 0 = Universal / Neutral
1 = Standard
2 = Standard 90°
4 = Square head
5 = Parallel

-Oblique-hinge

1. 2 □ . □□□□□□	Key
1. 2 □ . □□ K □□	Oblique-connector, hinge
1. 2 □ . □□□□□□	Connection-variant ¹⁾
1. 2 □ . □□□□ V	Stainless

- ¹⁾ 1 = Standard
2 = Standard 90°

-Oblique-bent anchor

1. 2 □ . □□□□□□ / □□□□	Key
1. 2 □ . □□ B □□ / □□□□	Oblique-connector, bent anchor
1. 2 □ . □□□□□□ / □□□□	Connection-variant ¹⁾
1. 2 □ . □□□□□□ / □□□□	Design L/R
1. 2 □ . □□□□□□ / □□□□	Angle
1. 2 □ . □□□□□□ / □□ V □	Stainless
1. 2 □ . □□□□□□ / □□□ E	Ground

- ¹⁾ 1 = Standard
2 = Standard 90°

-Miter-hinge

1. 2 □ . □□□□□□	Key
1. 2 □ . □ G □□	Miter-connector, hinge
1. 2 □ . □□□□□□	Connection-variant ¹⁾
1. 2 □ . □□□□ V	Stainless

- ¹⁾ 1 = Standard
2 = Standard 90°

-Miter-bent anchor

1. 2 □ . □□□□□□ / □□□□	Key
1. 2 □ . □ G □□ / □□□□	Miter-connector
1. 2 □ . □□ B □ / □□□□	Bent design
1. 2 □ . □□□□□□ / □□□□	Connection-variant ¹⁾
1. 2 □ . □□□□□□ / □□□□	Angle
1. 2 □ . □□□□□□ / □□ V	Stainless





- ¹⁾ 1 = Standard
2 = Standard 90°

-Screw-type

1. 2 □ . □□□□□□ / □□	Key
1. 2 □ . □ S □□□□ / □□	Screw-type-connector
1. 2 □ . □□□□□□ / □□	Type of anchor ¹⁾
1. 2 □ . □□□□ M □ / □□	Thread
1. 2 □ . □□□□□□ / □□	Thread-Ø
1. 2 □ . □□□□□□ / □□	Screw special length

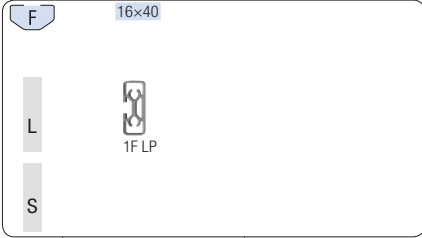
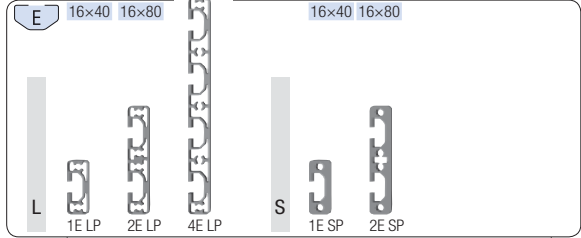
- ¹⁾ 1 = Standard
2 = Parallel 20 mm
3 = Parallel 30 mm
4 = Parallel 40 mm
5 = Parallel 50 mm

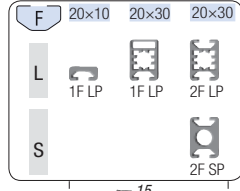
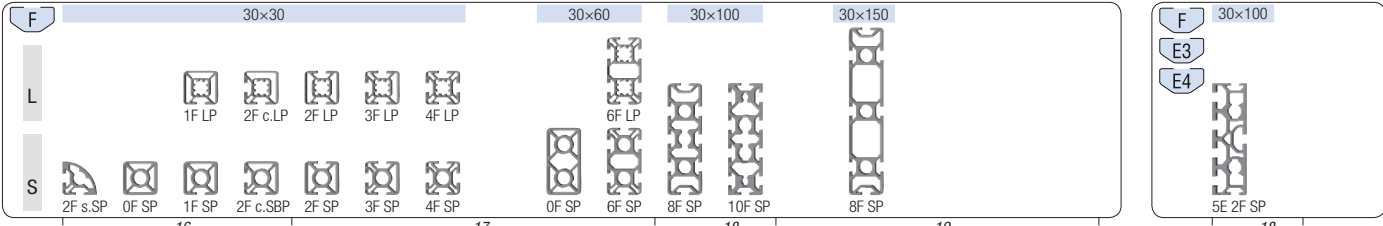
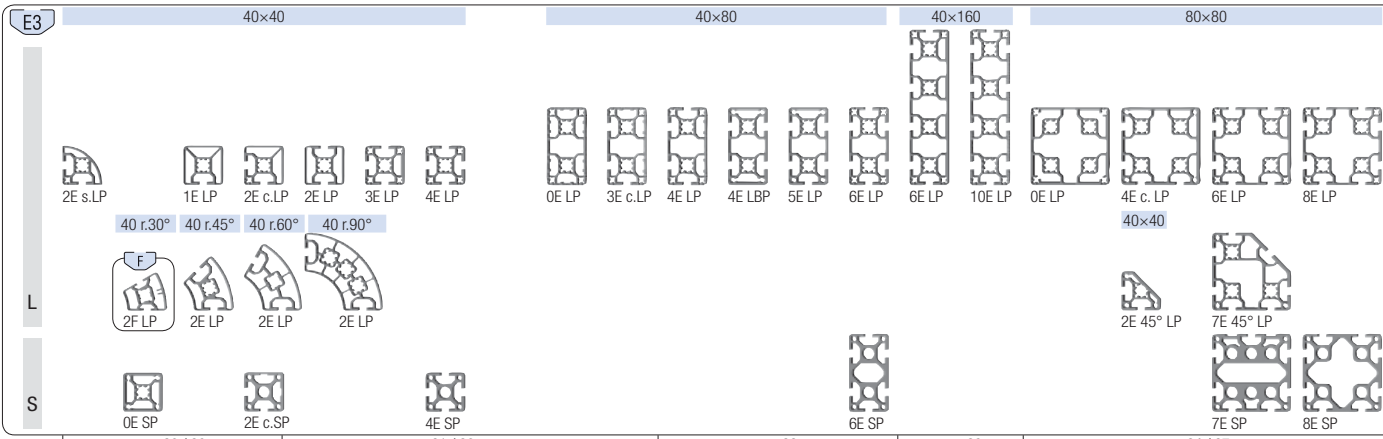
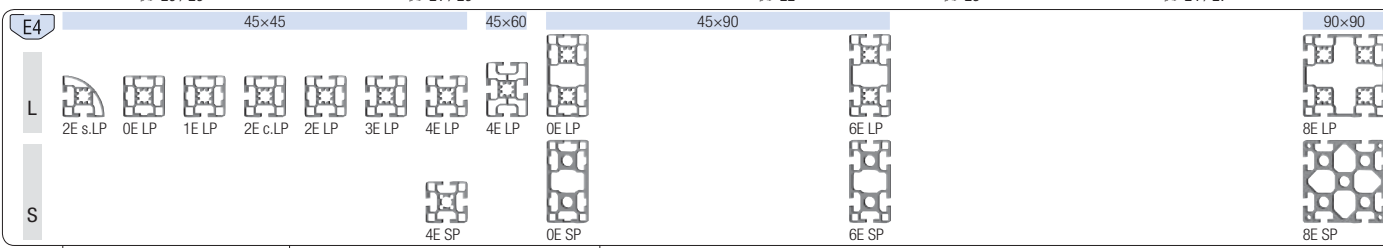
<div style="display: flex; align-items: center; justify-content: center;"> <div style="margin-right: 10px;"> □/□ □/□ □/□ </div> <div> Special cases: Screw-type connector parallel across and high Profile width for cross bushing Profile width for anchor </div> </div>	
--	--

	plain	plain	plain	plain
16	<p>16x40</p>  <p>L S</p> <p>1F LP</p> <p>12</p>		<p>16x40 16x80 16x160</p>  <p>L S</p> <p>1E LP 2E LP 4E LP 1E SP 2E SP</p> <p>12</p>	
20	<p>20x20 20x40</p>  <p>L S</p> <p>2H LP 4H LP 2H s.SP 2H c.SP 3H SP 4H SP 4H SP 6H LP 6H SP</p> <p>13 14</p>			<p>20x10 20x30 20x30</p>  <p>L S</p> <p>1F LP 1F LP 2F LP 2F SP</p> <p>15</p>
30	<p>30x30 30x60 30x100 30x150</p>  <p>L S</p> <p>1F LP 2F c.LP 2F LP 3F LP 4F LP 2F s.SP 0F SP 1F SP 2F c.SBP 2F SP 3F SP 4F SP 0F SP 6F LP 8F SP 10F SP 8F SP</p> <p>16 17 18 19</p>			
40	<p>E3 40x40 40x80 40x160 80x80</p>  <p>L S</p> <p>2E s.LP 1E LP 2E c.LP 2E LP 3E LP 4E LP 40 r.30° 40 r.45° 40 r.60° 40 r.90° 2F LP 2E LP 2E LP 2E LP 0E LP 3E c.LP 4E LP 4E LBP 5E LP 6E LP 6E LP 10E LP 0E LP 4E c.LP 6E LP 8E LP 2E 45° LP 7E 45° LP 0E SP 2E c.SP 4E SP 6E SP 7E SP 8E SP</p> <p>20 / 26 21 / 26 22 23 24 / 27</p>			
45	<p>E4 45x45 45x60 45x90 90x90</p>  <p>L S</p> <p>2E s.LP 0E LP 1E LP 2E c.LP 2E LP 3E LP 4E LP 4E LP 0E LP 6E LP 8E LP 4E SP 0E SP 6E SP 8E SP</p> <p>28 29 30</p>			
50	<p>E4</p>  <p>L S</p>			
60	<p>E4 60x60</p>  <p>L S</p> <p>2E LP 4E LP 2E SP 4E SP</p> <p>32</p>			

plain

plain

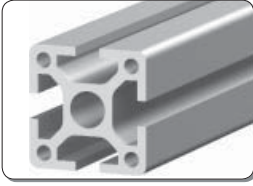

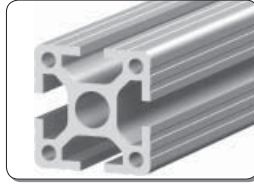

without grooves

grooves



with grooves

grooves

16	20	30	40	45	50	60	Profile group
							Slot type
							plain

L	light
S	heavy
P	plain
B	type B

octag.	octagonal
c.	corner
r.	round
s.	soft
a.	angle

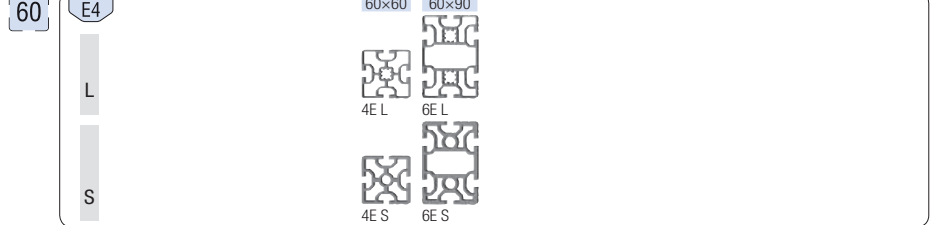
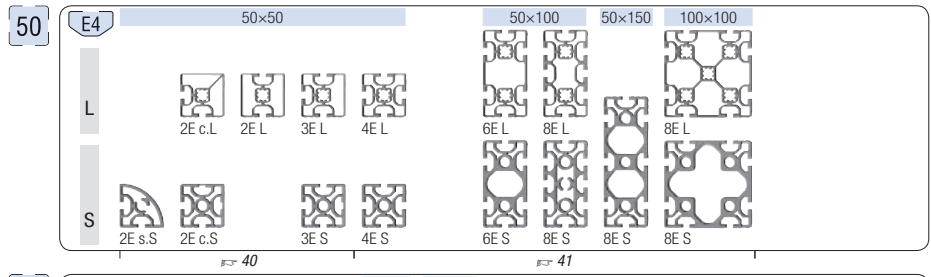
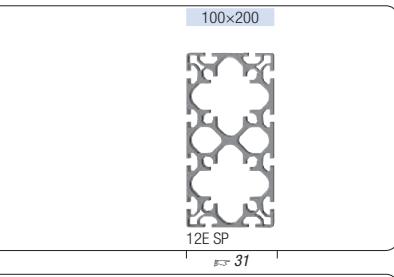
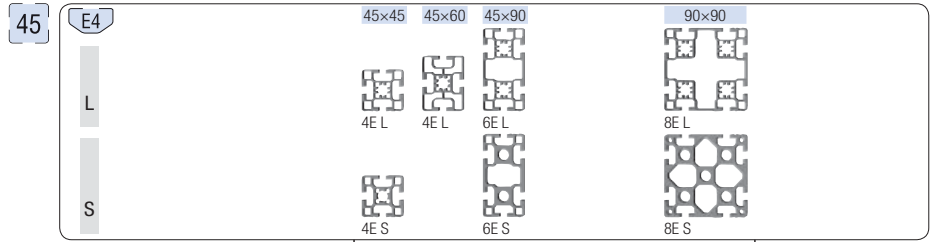
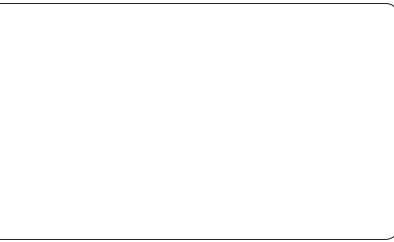
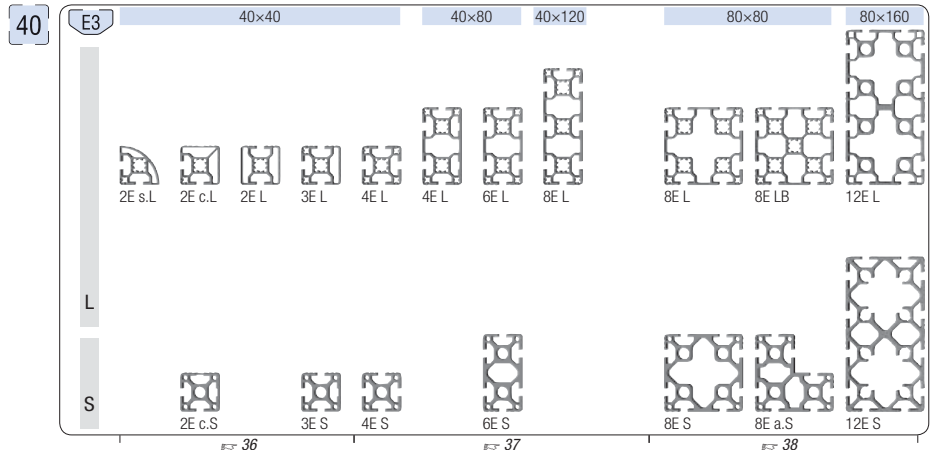
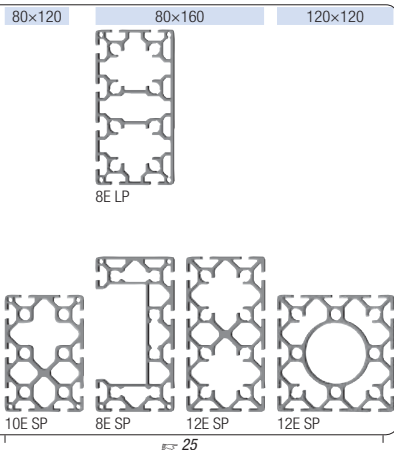
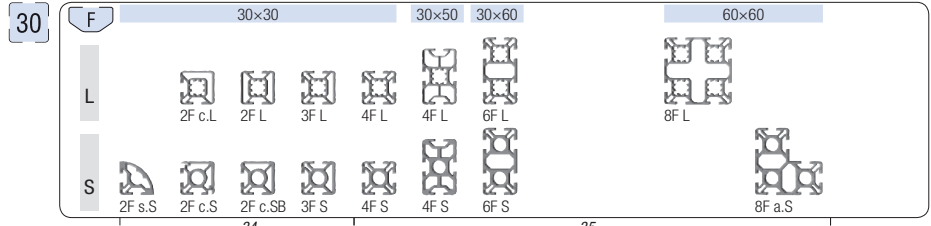
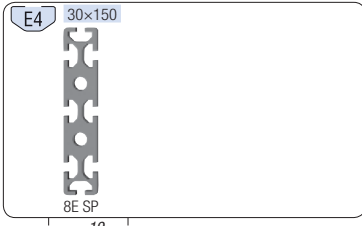

Profiles round **Profiles octagonal**

plain

48 round 30 octag. 40 octag.

1E SP 2E c.SP 2E SP 8F SP 8E SP

➔ 43

Telescopic profiles

40

plain

E3 40x40 80x80 120x120 160x160

S 8E SBP 12E SP 16E SP

➔ Catalogue "The Telescopic System"

Panel profiles **Wire net profiles**

30

plain

F 30x30 30x50

0F LP 2F c.LP 4 3F LP 4 3F LP 4 2F LP 7.5 2F LP 7.5

L 2F LP 5 2F LP 5 2F LP 6

➔ 44 ➔ 47

E3 40x40 40x60 60x80

L 2E c.LP 4 3E LP 4 3E LP 4 5E LP 4 6E LP 4 2E LP 7.5 2E 1F LP 7.5

➔ 45 ➔ 47

E4 50x50

L 2E c.LP 4 3E LP 4

➔ 46

Glass Panel Profiles

60

plain

E4 57x57 60x57 60x117 120x120

Compression profile 57x4 Compression profile 60x4 Compression profile 60x4 with chamfer















Compression profile 61x4

L 2E c.LP 1E LP 4E LP 6E LP 4E a.LP





➔ Catalogue "Glass Panel Profiles"

plain

E-trunking profiles

Lid 30 	Lid 40 					Lid 80 	Lid 200 	Profile pre-cut lid 120 
 30×30	 40×20 for Clips	 40×20	 40×40	 40×80	 80×40	 80×80	 200×50	 80×160 8E SP
↔ 48				↔ 49			↔ 50	



19" profiles

 PG 30	 PG 40	 PG 50	
↔ 50			



30

plain





Tube profiles

 L	 LP 30×60	 LP 30×100
↔ 51		





Tubes

 Ø20×2	 Ø30×3	 Ø40×4
↔ 51		



Profile pre-cut lids

 30	 40	 50	 120
↔ 52			

Sliding profiles

 30×14	 30×26	 33×14	 33×26
↔ 53			



Wire net mounting profiles

	 33×10
↔ 52	

C-track

↔ 53

Grab handle profiles

	
↔ 52	



U-profile





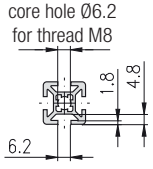

 40
↔ 53

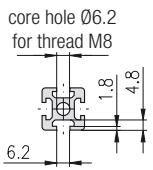

1



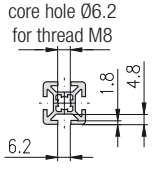

light					
Description		Profile 16×40, 1F, LP	Profile 16×40, 1E, LP	Profile 16×80, 2E, LP	Profile 16×160, 4E, LP
bar, 6 m		1.10.016040.14LP.60	1.09.016040.14LP.60	1.09.016080.24LP.60	1.09.016160.44LP.60
packing unit (number)		1.10.016040.14LP.61 (20)	1.09.016040.14LP.61 (20)	1.09.016080.24LP.61 (10)	1.09.016160.44LP.61 (5)
moment of inertia	cm ⁴	$I_x = 4.4$ $I_y = 0.8$	$I_x = 4.3$ $I_y = 0.8$	$I_x = 30.7$ $I_y = 1.6$	$I_x = 221.0$ $I_y = 3.2$
moment of resistance	cm ³	$W_x = 2.2$ $W_y = 0.8$	$W_x = 2.2$ $W_y = 0.8$	$W_x = 7.7$ $W_y = 1.6$	$W_x = 27.5$ $W_y = 3.2$
weight	kg/m	$G = 0.87$	$G = 0.75$	$G = 1.49$	$G = 2.6$

heavy					
Description			Profile 16×40, 1E, SP	Profile 16×80, 2E, SP	
bar, 6 m			1.09.016040.14SP.60	1.09.016080.24SP.60	
packing unit (number)			1.09.016040.14SP.61 (20)	1.09.016080.24SP.61 (10)	
moment of inertia	cm ⁴		$I_x = 7.2$ $I_y = 1.1$	$I_x = 48.3$ $I_y = 2.2$	
moment of resistance	cm ³		$W_x = 3.6$ $W_y = 1.1$	$W_x = 12.0$ $W_y = 2.2$	
weight	kg/m		$G = 1.14$	$G = 2.11$	

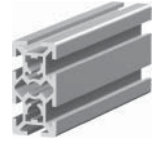
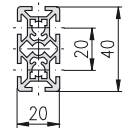
light				
				
				
Description			Profile 20×20, 2H, LP	
bar, 6 m			1.10.020020.23LP.60	
packing unit (number)			1.10.020020.23LP.61 (10)	
moment of inertia cm ⁴			$I_x = 1.0$ $I_y = 0.8$	
moment of resistance cm ³			$W_x = 1.0$ $W_y = 0.8$	
weight kg/m			$G = 0.58$	

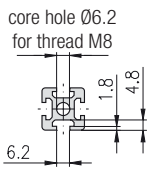
heavy				
				
				
Description	Profile 20×20, 2H, soft, SP	Profile 20×20, 2H, corner, SP		Profile 20×20, 3H, SP
bar, 6 m	1.10.020020.21SP.60	1.10.020020.22SP.60		1.10.020020.33SP.60
packing unit (number)	1.10.020020.21SP.61 (10)	1.10.020020.22SP.61 (10)		1.10.020020.33SP.61 (10)
moment of inertia cm ⁴	$I_x = 0.6$ $I_y = 0.6$	$I_x = 1.0$ $I_y = 1.0$		$I_x = 0.9$ $I_y = 0.9$
moment of resistance cm ³	$W_x = 0.6$ $W_y = 0.6$	$W_x = 0.9$ $W_y = 0.9$		$W_x = 0.9$ $W_y = 0.9$
weight kg/m	$G = 0.52$	$G = 0.68$		$G = 0.65$



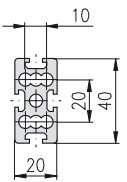
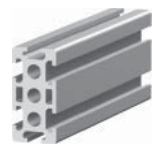
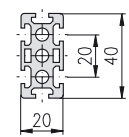

light				
	 		 	
Description	Profile 20×20, 4H, LP		Profile 20×40, 6H, LP	
bar, 6 m	1.10.020020.43LP.60		1.10.020040.64LP.60	
packing unit (number)	1.10.020020.43LP.61 (10)		1.10.020040.64LP.61 (10)	
moment of inertia cm ⁴	$I_x = 0.8$ $I_y = 0.8$		$I_x = 5.3$ $I_y = 1.4$	
moment of resistance cm ³	$W_x = 0.8$ $W_y = 0.8$		$W_x = 2.6$ $W_y = 1.4$	
weight kg/m	$G = 0.53$		$G = 0.9$	





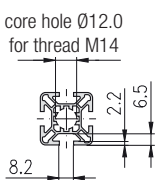

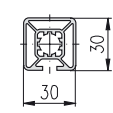
heavy				
	 	 	 	
Description	Profile 20×20, 4H, SP	Profile 20×40, 4H, SP	Profile 20×40, 6H, SP	
bar, 6 m	1.10.020020.43SP.60	1.10.020040.44SP.60	1.10.020040.64SP.60	
packing unit (number)	1.10.020020.43SP.61 (10)	1.10.020040.44SP.61 (10)	1.10.020040.64SP.61 (10)	
moment of inertia cm ⁴	$I_x = 0.9$ $I_y = 0.9$	$I_x = 7.0$ $I_y = 2.0$	$I_x = 6.4$ $I_y = 1.7$	
moment of resistance cm ³	$W_x = 0.9$ $W_y = 0.9$	$W_x = 3.5$ $W_y = 2.0$	$W_x = 3.2$ $W_y = 1.7$	
weight kg/m	$G = 0.62$	$G = 1.3$	$G = 1.3$	

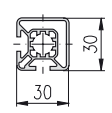

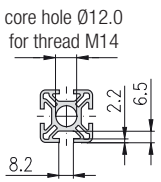

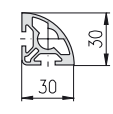
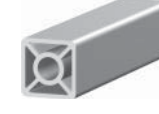
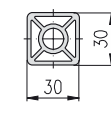

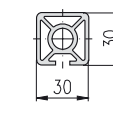
light					
	Description	Profile 20×10, 1F, LP	Profile 20×30, 1F, LP	Profile 20×30, 2F, LP	
	bar, 6 m	1.11.020010.14LP.60	1.11.020030.14LP.60	1.11.020030.24LP.60	
packing unit (number)	1.11.020010.14LP.61 (10)	1.11.020030.14LP.61 (10)	1.11.020030.24LP.61 (10)		
moment of inertia cm ⁴	$I_x = 0.1$ $I_y = 0.6$	$I_x = 2.2$ $I_y = 1.4$	$I_x = 2.2$ $I_y = 1.5$		
moment of resistance cm ³	$W_x = 0.2$ $W_y = 0.5$	$W_x = 1.5$ $W_y = 1.4$	$W_x = 1.5$ $W_y = 1.5$		
weight kg/m	$G = 0.35$	$G = 0.7$	$G = 0.74$		

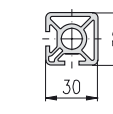



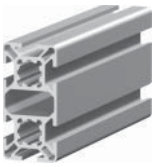

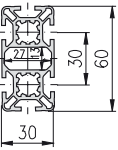

heavy				
	Description		Profile 20×30, 2F, SP	
	bar, 6 m			1.11.020030.24SP.60
packing unit (number)			1.11.020030.24SP.61 (10)	
moment of inertia cm ⁴			$I_x = 2.6$ $I_y = 1.9$	
moment of resistance cm ³			$W_x = 1.7$ $W_y = 1.7$	
weight kg/m			$G = 1.0$	



light				
			 	 
Description			Profile 30×30, 1F, LP	Profile 30×30, 2F, corner, LP
bar, 6 m			1.11.030030.13LP.60	1.11.030030.22LP.60
packing unit (number)			1.11.030030.13LP.61 (10)	1.11.030030.22LP.61 (10)
moment of inertia cm ⁴			$I_x = 3.1$ $I_y = 3.1$	$I_x = 3.2$ $I_y = 3.2$
moment of resistance cm ³			$W_x = 2.1$ $W_y = 2.1$	$W_x = 2.1$ $W_y = 2.1$
weight kg/m			$G = 0.9$	$G = 0.9$

heavy				
	 	 	 	 
Description	Profile 30×30, 2F, soft, SP	Profile 30×30, 0F, SP	Profile 30×30, 1F, SP	Profile 30×30, 2F, corner, SBP
bar, 6 m	1.11.030030.21SP.60	1.11.030030.03SP.60	1.11.030030.13SP.60	1.11.030030.22SBP.60
packing unit (number)	1.11.030030.21SP.61 (10)	1.11.030030.03SP.61 (10)	1.11.030030.13SP.61 (10)	1.11.030030.22SBP.61(10)
moment of inertia cm ⁴	$I_x = 2.7$ $I_y = 2.7$	$I_x = 4.4$ $I_y = 4.4$	$I_x = 4.3$ $I_y = 4.0$	$I_x = 3.7$ $I_y = 3.7$
moment of resistance cm ³	$W_x = 1.6$ $W_y = 1.6$	$W_x = 2.3$ $W_y = 2.3$	$W_x = 2.9$ $W_y = 2.6$	$W_x = 2.4$ $W_y = 2.4$
weight kg/m	$G = 0.9$	$G = 1.3$	$G = 1.2$	$G = 1.1$

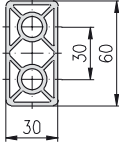
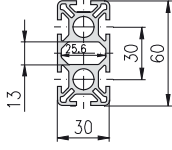

				
				
Profile 30×30, 2F, LP	Profile 30×30, 3F, LP	Profile 30×30, 4F, LP		Profile 30×60, 6F, LP
1.11.030030.23LP.60	1.11.030030.33LP.60	1.11.030030.43LP.60		1.11.030060.64LP.60
1.11.030030.23LP.61 (10)	1.11.030030.33LP.61 (10)	1.11.030030.43LP.61 (10)		1.11.030060.64LP.61 (6)
$I_x = 3.2$ $I_y = 3.2$ $W_x = 2.1$ $W_y = 2.1$ $G = 0.9$	$I_x = 3.0$ $I_y = 3.0$ $W_x = 2.0$ $W_y = 2.0$ $G = 0.9$	$I_x = 3.3$ $I_y = 3.3$ $W_x = 2.2$ $W_y = 2.2$ $G = 0.9$		$I_x = 21.1$ $I_y = 5.9$ $W_x = 7.4$ $W_y = 3.9$ $G = 1.6$

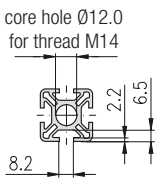
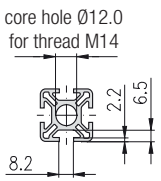
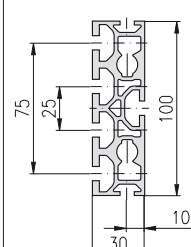
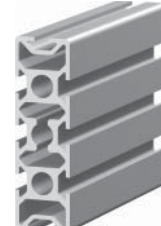
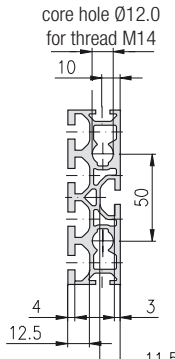
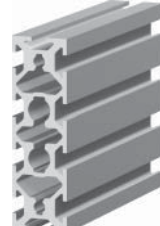
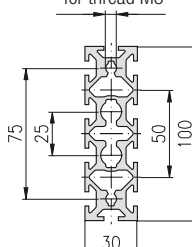
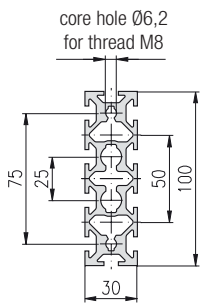
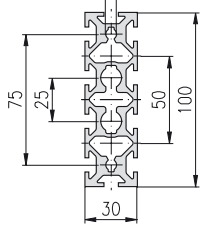

				
				
Profile 30×30, 2F, SP	Profile 30×30, 3F, SP	Profile 30×30, 4F, SP	Profile 30×60, 0F, SP	Profile 30×60, 6F, SP
1.11.030030.23SP.60	1.11.030030.33SP.60	1.11.030030.43SP.60	1.11.030060.04SP.60	1.11.030060.65SP.60
1.11.030030.23SP.61 (10)	1.11.030030.33SP.61 (10)	1.11.030030.43SP.61 (10)	1.11.030060.04SP.61 (6)	1.11.030060.65SP.61 (6)
$I_x = 3.6$ $I_y = 3.9$ $W_x = 2.4$ $W_y = 2.6$ $G = 1.1$	$I_x = 3.5$ $I_y = 3.7$ $W_x = 2.4$ $W_y = 2.4$ $G = 1.1$	$I_x = 3.5$ $I_y = 3.5$ $W_x = 2.4$ $W_y = 2.4$ $G = 1.1$	$I_x = 29.0$ $I_y = 7.8$ $W_x = 9.6$ $W_y = 5.2$ $G = 2.2$	$I_x = 25.0$ $I_y = 7.0$ $W_x = 8.3$ $W_y = 4.7$ $G = 2.1$

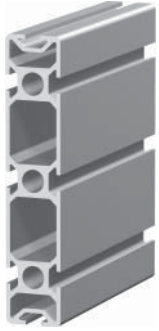
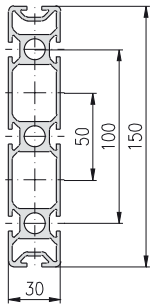
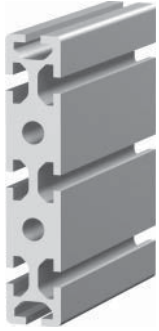
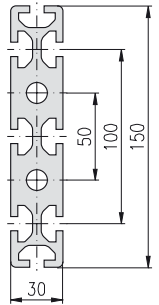

light				
Description				
bar, 6 m				
packing unit (number)				
moment of inertia cm ⁴				
moment of resistance cm ³				
weight kg/m				

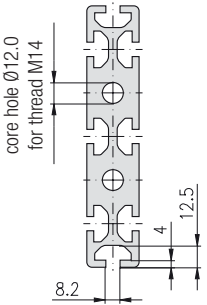

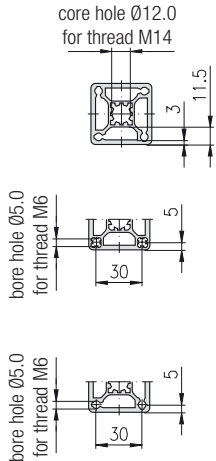
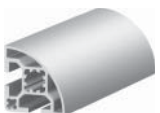
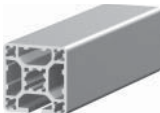
heavy	  	  	  
Description	Profile 30×100, 5E, 2F, SP	Profile 30×100, 8F, SP	Profile 30×100, 10F, SP
bar, 6 m	1.11.030100.74SP.60	1.11.030100.84SP.60	1.11.030100.104SP.60
packing unit (number)	1.11.030100.74SP.61 (4)	1.11.030100.84SP.61 (4)	1.11.030100.104SP.61 (4)
moment of inertia cm ⁴	$I_x = 108.9$ $I_y = 12.4$	$I_x = 115.0$ $I_y = 11.6$	$I_x = 127.0$ $I_y = 11.9$
moment of resistance cm ³	$W_x = 21.7$ $W_y = 8.3$	$W_x = 22.9$ $W_y = 7.7$	$W_x = 25.4$ $W_y = 7.9$
weight kg/m	$G = 3.5$	$G = 3.4$	$G = 3.6$

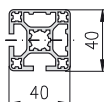
1

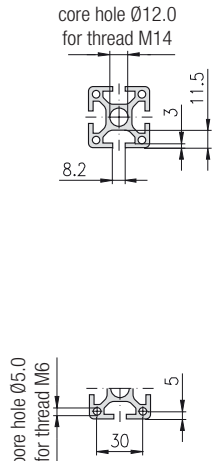
 	  <p>Connection possibilities  106, Universal connector  110, ST-Connector</p>  <p>core hole Ø12.0 for thread M14</p>		
<p>Profile 30×150, 8F, SP</p>	<p>Profile 30×150, 8E, SP</p>		
<p>1.11.030150.85SP.60</p>	<p>1.11.030150.84SP.60</p>		
<p>1.11.030150.85SP.61 (2)</p>	<p>1.11.030150.84SP.61 (2)</p>		
<p>$I_x = 340.0$ $I_y = 16.0$ $W_x = 45.0$ $W_y = 11.0$ $G = 4.1$</p>	<p>$I_x = 481.0$ $I_y = 25.1$ $W_x = 64.1$ $W_y = 16.7$ $G = 7.9$</p>		

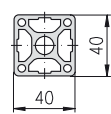
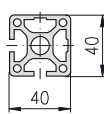
light				
				
Description	Profile 40×40, 2E, soft, LP		Profile 40×40, 1E, LP	Profile 40×40, 2E, corner, LP
bar, 6 m	1.11.040040.21LP.60		1.11.040040.13LP.60	1.11.040040.22LP.60
packing unit (number)	1.11.040040.21LP.61 (8)		1.11.040040.13LP.61 (8)	1.11.040040.22LP.61 (8)
moment of inertia cm ⁴	$I_x = 6.4$ $I_y = 6.4$		$I_x = 10.1$ $I_y = 9.8$	$I_x = 9.9$ $I_y = 9.9$
moment of resistance cm ³	$W_x = 3.8$ $W_y = 3.8$		$W_x = 5.0$ $W_y = 4.8$	$W_x = 4.9$ $W_y = 4.9$
weight kg/m	$G = 1.2$		$G = 1.5$	$G = 1.5$

heavy				
				
Description	Profile 40×40, 0E, SP		Profile 40×40, 2E, corner, SP	
bar, 6 m	1.11.040040.03SP.60		1.11.040040.22SP.60	
packing unit (number)	1.11.040040.03SP.61 (8)		1.11.040040.22SP.61 (8)	
moment of inertia cm ⁴	$I_x = 12.6$ $I_y = 12.6$		$I_x = 12.0$ $I_y = 12.0$	
moment of resistance cm ³	$W_x = 6.3$ $W_y = 6.3$		$W_x = 6.0$ $W_y = 6.0$	
weight kg/m	$G = 2.0$		$G = 2.0$	

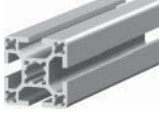
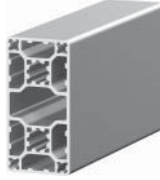
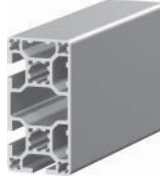
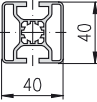
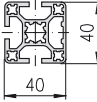
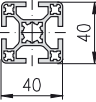
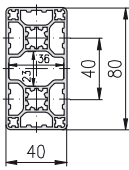
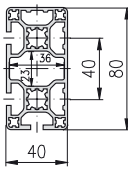
				
				
Profile 40×40, 2E, LP	Profile 40×40, 3E, LP	Profile 40×40, 4E, LP	Profile 40×80, 0E, LP	Profile 40×80, 3E, corner, LP
1.11.040040.23LP.60	1.11.040040.33LP.60	1.11.040040.43LP.60	1.11.040080.04LP.60	1.11.040080.32LP.60
1.11.040040.23LP.61 (8)	1.11.040040.33LP.61 (8)	1.11.040040.43LP.61 (8)	1.11.040080.04LP.61 (8)	1.11.040080.32LP.61 (4)
$I_x = 8.2$ $I_y = 7.5$ $W_x = 4.1$ $W_y = 3.8$ $G = 1.3$	$I_x = 9.5$ $I_y = 9.9$ $W_x = 4.7$ $W_y = 4.9$ $G = 1.5$	$I_x = 9.6$ $I_y = 9.6$ $W_x = 4.7$ $W_y = 4.7$ $G = 1.5$	$I_x = 66.8$ $I_y = 18.4$ $W_x = 16.7$ $W_y = 9.2$ $G = 2.7$	$I_x = 66.9$ $I_y = 18.1$ $W_x = 16.7$ $W_y = 9.0$ $G = 2.6$

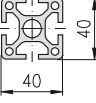
				
				
		Profile 40×40, 4E, SP		
		1.11.040040.43SP.60		
		1.11.040040.43SP.61 (8)		
		$I_x = 12.0$ $I_y = 12.0$ $W_x = 6.0$ $W_y = 6.0$ $G = 2.0$		

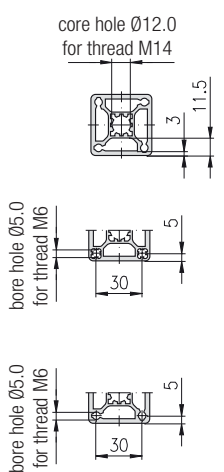
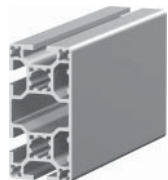
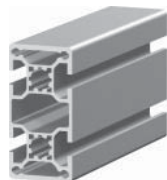
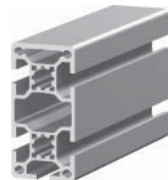
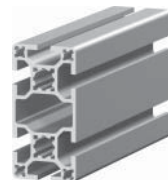
light				
				
Description	Profile 40×80, 4E, LP	Profile 40×80, 4E, LBP	Profile 40×80, 5E, LP	Profile 40×80, 6E, LP
bar, 6 m	1.11.040080.44LP.60	1.11.040080.44LBP.60	1.11.040080.54LP.60	1.11.040080.64LP.60
packing unit (number)	1.11.040080.44LP.61 (4)	1.11.040080.44LBP.61 (4)	1.11.040080.54LP.61 (4)	1.11.040080.64LP.61 (4)
moment of inertia cm ⁴	$I_x = 65.8$ $I_y = 18.1$	$I_x = 74.5$ $I_y = 18.3$	$I_x = 72.2$ $I_y = 18.1$	$I_x = 65.4$ $I_y = 17.5$
moment of resistance cm ³	$W_x = 16.5$ $W_y = 9.0$	$W_x = 18.6$ $W_y = 9.2$	$W_x = 18.0$ $W_y = 9.0$	$W_x = 16.4$ $W_y = 8.8$
weight kg/m	$G = 2.6$	$G = 2.8$	$G = 2.8$	$G = 2.5$

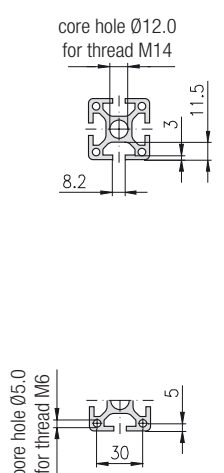
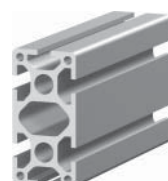
heavy				
				
Description				Profile 40×80, 6E, SP
bar, 6 m				1.11.040080.64SP.60
packing unit (number)				1.11.040080.64SP.61 (4)
moment of inertia cm ⁴				$I_x = 82.0$ $I_y = 23.4$
moment of resistance cm ³				$W_x = 20.5$ $W_y = 11.7$
weight kg/m				$G = 3.8$

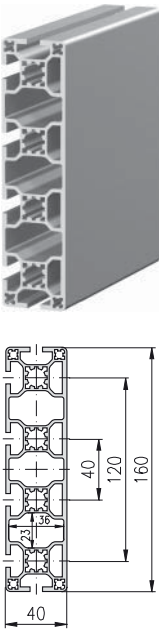
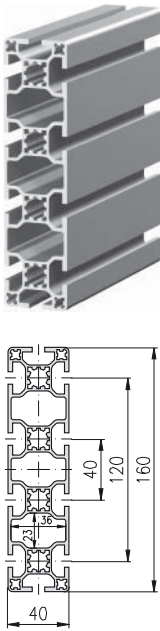
				
<p>Profile 40×160, 6E, LP</p>	<p>Profile 40×160, 10E, LP</p>			
<p>1.11.040160.64LP.60</p>	<p>1.11.040160.104LP.60</p>			
<p>1.11.040160.64LP.61 (2)</p>	<p>1.11.040160.104LP.61 (2)</p>			
<p>$I_x = 450.4$ $I_y = 36.3$ $W_x = 56.3$ $W_y = 18.1$ $G = 5.0$</p>	<p>$I_x = 433.5$ $I_y = 33.1$ $W_x = 54.2$ $W_y = 16.5$ $G = 4.7$</p>			

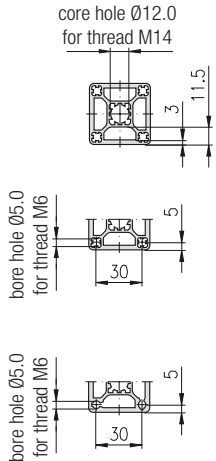
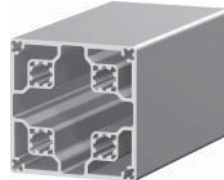
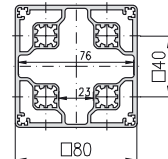
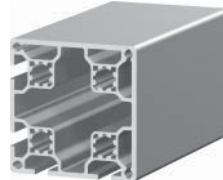
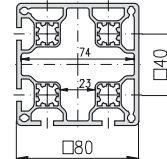
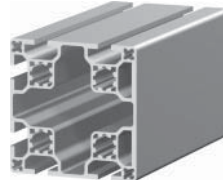
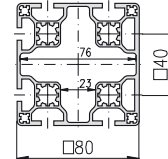
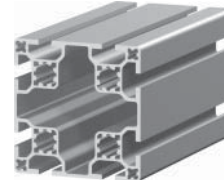
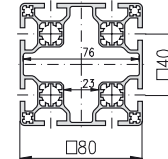

light				
	 	 	 	 
Description	Profile 80×80, OE, LP	Profile 80×80, 4E, corner, LP	Profile 80×80, 6E, LP	Profile 80×80, 8E, LP
bar, 6 m	1.11.080080.03LP.60	1.11.080080.42LP.60	1.11.080080.63LP.60	1.11.080080.83LP.60
packing unit (number)	1.11.080080.03LP.61 (2)	1.11.080080.42LP.61 (2)	1.11.080080.63LP.61 (2)	1.11.080080.83LP.61 (2)
moment of inertia cm ⁴	$I_x = 135.0$ $I_y = 135.0$	$I_x = 128.0$ $I_y = 128.0$	$I_x = 121.3$ $I_y = 116.0$	$I_x = 114.0$ $I_y = 114.0$
moment of resistance cm ³	$W_x = 33.5$ $W_y = 33.5$	$W_x = 32.0$ $W_y = 32.0$	$W_x = 30.3$ $W_y = 29.0$	$W_x = 28.4$ $W_y = 28.4$
weight kg/m	$G = 4.7$	$G = 4.5$	$G = 4.2$	$G = 4.1$

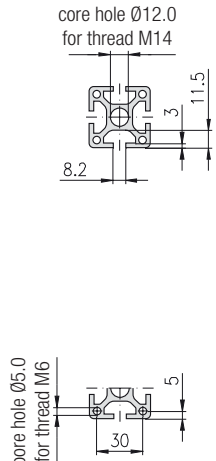
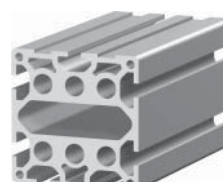
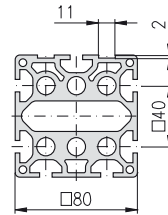
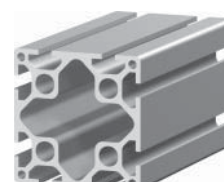
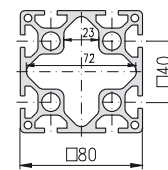
heavy				
	 	 		
Description			Profile 80×80, 7E, SP	Profile 80×80, 8E, SP
bar, 6 m			1.11.080080.79SP.60	1.11.080080.83SP.60
packing unit (number)			1.11.080080.79SP.61 (2)	1.11.080080.83SP.61 (2)
moment of inertia cm ⁴			$I_x = 173.0$ $I_y = 160.0$	$I_x = 166.0$ $I_y = 166.0$
moment of resistance cm ³			$W_x = 43.3$ $W_y = 40.0$	$W_x = 41.4$ $W_y = 41.4$
weight kg/m			$G = 7.6$	$G = 5.9$

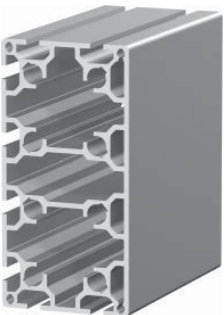
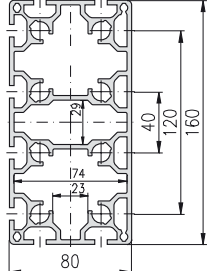
	 			
	Profile 80×160, 8E, LP			
	1.11.080160.84LP.60			
	1.11.080160.84LP.61 (2)			
	$I_x = 828.0$ $I_y = 259.0$ $W_x = 104.0$ $W_y = 65.0$ $G = 8.6$			

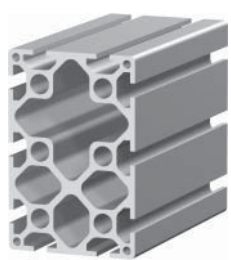
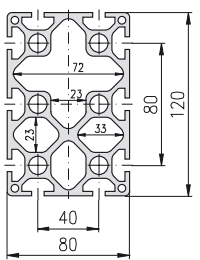
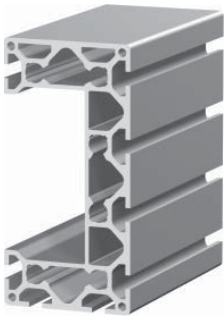
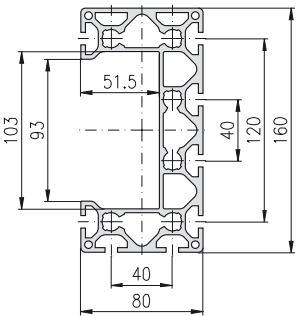
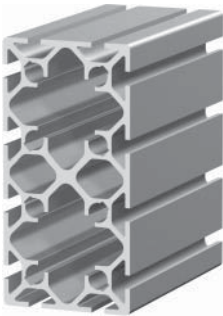
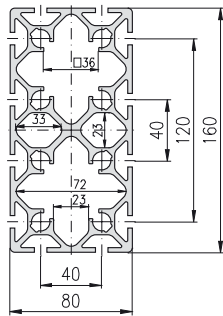
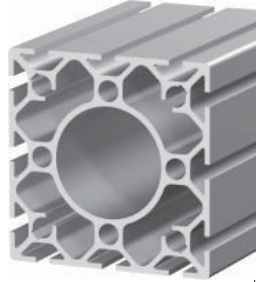
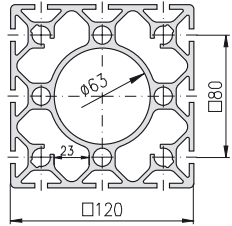
 	 	<p>Application <i>E-trunking profiles, 50, 316-319</i></p>  	 
Profile 80×120, SP	Profile 80×160, 8E, SP	Profile 80×160, 12E, SP	Profile 120×120, 10E, 12E, SP
1.11.080120.104SP.60	1.11.080160.89SP.60	1.11.080160.124SP.60	1.11.120120.123SP.60
1.11.080120.104SP.61 (2)	1.11.080160.89SP.61 (2)	1.11.080160.124SP.61 (2)	1.11.120120.123SP.61 (2)
$I_x = 449.9$ $I_y = 217.8$ $W_x = 72.6$ $W_y = 54.4$ $G = 8.6$	$I_x = 944.0$ $I_y = 183.0$ $W_x = 118.0$ $W_y = 45.8$ $G = 7.9$	$I_x = 883.0$ $I_y = 269.0$ $W_x = 110.0$ $W_y = 67.3$ $G = 9.4$	$I_x = 624.0$ $I_y = 624.0$ $W_x = 104.0$ $W_y = 104.0$ $G = 10.6$

light	F-Slot			Connection possibilities and calculation formulas for polygons ↗ 1.2E
F-Slot				
core hole Ø12.0 for thread M14 				
E3-Slot				
core hole Ø12.0 for thread M14 				
Description	Profile 40, round 30 deg., 2F, LP	Profile 40, round 45 deg., 2E, LP	Profile 40, round 60 deg., 2E, LP	
bar, 6 m	1.11.040R30.20LP.60	1.11.040R45.20LP.60	1.11.040R60.20LP.60	
packing unit (number)	1.11.040R30.20LP.61 (8)	1.11.040R45.20LP.61 (8)	1.11.040R60.20LP.61 (8)	
moment of inertia cm ⁴	$I_x = 6.0$ $I_y = 4.8$	$I_x = 14.5$ $I_y = 8.0$	$I_x = 30.0$ $I_y = 10.5$	
moment of resistance cm ³	$W_x = 3.0$ $W_y = 2.4$	$W_x = 4.9$ $W_y = 3.7$	$W_x = 7.6$ $W_y = 4.6$	
weight kg/m	G = 1.2	G = 1.6	G = 1.9	

light			Connection possibilities and calculation formulas for polygons ↗ 1.2E	
core hole Ø12.0 for thread M14 				
Description	Profile 40, round 90 deg., 2E, LP			
bar, 6 m	1.11.040R90.20LP.60			
packing unit (number)	1.11.040R90.20LP.61 (4)			
moment of inertia cm ⁴	$I_x = 89.0$ $I_y = 89.0$			
moment of resistance cm ³	$W_x = 16.0$ $W_y = 16.0$			
weight kg/m	G = 3.0			

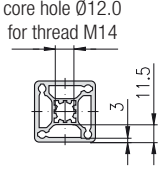
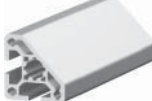
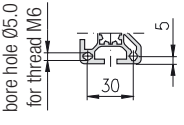
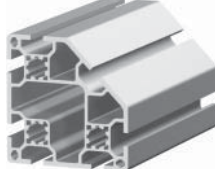
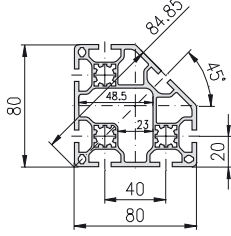

<p>light</p>	  	 		
<p>Description</p>	<p>Profile 40×40, 2E, 45 deg., LP</p>	<p>Profile 80×80, 7E, 45 deg., LP</p>		
<p>bar, 6 m</p>	<p>1.11.040040.28LP.60</p>	<p>1.11.080080.78LP.60</p>		
<p>packing unit (number)</p>	<p>1.11.040040.28LP.61 (8)</p>	<p>1.11.080080.78LP.61 (2)</p>		
<p>moment of inertia cm⁴ moment of resistance cm³ weight kg/m</p>	<p>$I_x = 7.3$ $I_y = 7.3$ $W_x = 3.9$ $W_y = 3.9$ $G = 1.4$</p>	<p>$I_x = 99.3$ $I_y = 99.3$ $W_x = 24.8$ $W_y = 24.8$ $G = 4.0$</p>		

1

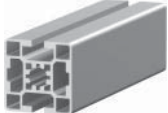
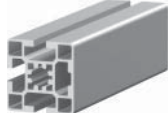
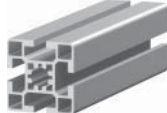
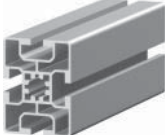
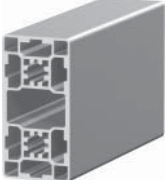
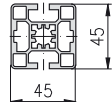
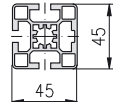
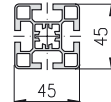
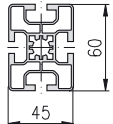
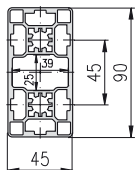

light				
Description	Profile 45×45, 2E, soft, LP	Profile 45×45, 0E, LP	Profile 45×45, 1E, LP	Profile 45×45, 2E, corner, LP
bar, 6 m	1.11.045045.21LP.60	1.11.045045.03LP.60	1.11.045045.13LP.60	1.11.045045.22LP.60
packing unit (number)	1.11.045045.21LP.61 (8)	1.11.045045.03LP.61 (8)	1.11.045045.13LP.61 (8)	1.11.045045.22LP.61 (8)
moment of inertia cm ⁴	$I_x = 11.4$ $I_y = 11.4$	$I_x = 15.5$ $I_y = 15.5$	$I_x = 14.7$ $I_y = 15.5$	$I_x = 14.7$ $I_y = 14.7$
moment of resistance cm ³	$W_x = 5.1$ $W_y = 5.1$	$W_x = 6.9$ $W_y = 6.9$	$W_x = 6.5$ $W_y = 6.8$	$W_x = 6.6$ $W_y = 6.6$
weight kg/m	G = 1.6	G = 2.2	G = 2.1	G = 2.0

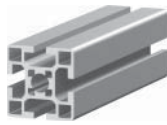
heavy				
Description				
bar, 6 m				
packing unit (number)				
moment of inertia cm ⁴				
moment of resistance cm ³				
weight kg/m				

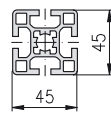
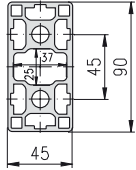
				
				
Profile 45×45, 2E, LP	Profile 45×45, 3E, LP	Profile 45×45, 4E, LP	Profile 45×60, 4E, LP	Profile 45×90, 0E, LP
1.11.045045.23LP.60	1.11.045045.33LP.60	1.11.045045.43LP.60	1.11.045060.44LP.60	1.11.045090.04LP.60
1.11.045045.23LP.61 (8)	1.11.045045.33LP.61 (8)	1.11.045045.43LP.61 (8)	1.11.045060.44LP.61 (6)	1.11.045090.04LP.61 (4)
$I_x = 14.0$ $I_y = 15.5$ $W_x = 6.2$ $W_y = 6.9$ $G = 2.0$	$I_x = 14.0$ $I_y = 14.7$ $W_x = 6.2$ $W_y = 6.5$ $G = 2.1$	$I_x = 13.5$ $I_y = 13.5$ $W_x = 6.0$ $W_y = 6.0$ $G = 1.9$	$I_x = 26.5$ $I_y = 16.0$ $W_x = 9.0$ $W_y = 7.2$ $G = 2.3$	$I_x = 107.5$ $I_y = 30.4$ $W_x = 23.9$ $W_y = 13.5$ $G = 3.6$

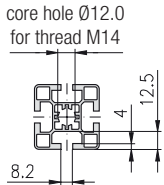
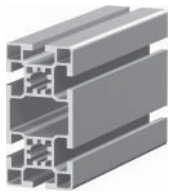
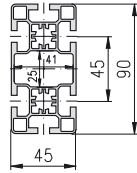
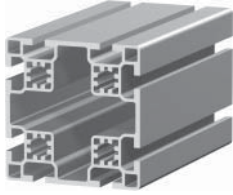
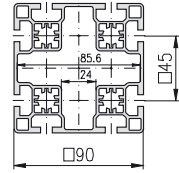
				
				
		Profile 45×45, 4E, SP		Profile 45×90, 0E, SP
		1.11.045045.43SP.60		1.11.045090.04SP.60
		1.11.045045.43SP.61 (8)		1.11.045090.04SP.61 (4)
		$I_x = 15.5$ $I_y = 15.5$ $W_x = 6.9$ $W_y = 6.9$ $G = 2.1$		$I_x = 134.3$ $I_y = 36.3$ $W_x = 29.8$ $W_y = 16.2$ $G = 4.7$

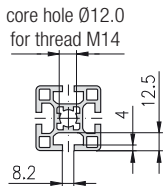
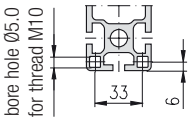
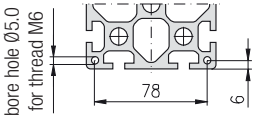

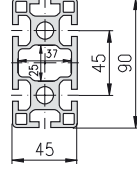
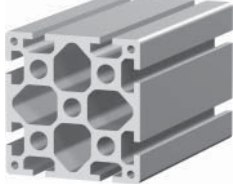
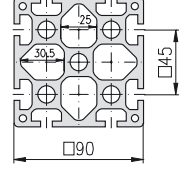
light					
		 	 		
Description	Profile 45×90, 6E, LP	Profile 90×90, 8E, LP			
bar, 6 m	1.11.045090.64LP.60	1.11.090090.83LP.60			
packing unit (number)	1.11.045090.64LP.61 (4)	1.11.090090.83LP.61 (2)			
moment of inertia cm ⁴	$I_x = 98.0$ $I_y = 27.5$	$I_x = 190.5$ $I_y = 190.5$			
moment of resistance cm ³	$W_x = 21.8$ $W_y = 12.2$	$W_x = 42.3$ $W_y = 42.3$			
weight kg/m	$G = 3.3$	$G = 5.6$			

heavy					
  		 	 		
Description	Profile 45×90, 6E, SP	Profile 90×90, 8E, SP			
bar, 6 m	1.11.045090.64SP.60	1.11.090090.83SP.60			
packing unit (number)	1.11.045090.64SP.61 (4)	1.11.090090.83SP.61 (2)			
moment of inertia cm ⁴	$I_x = 126.0$ $I_y = 34.0$	$I_x = 282.0$ $I_y = 282.0$			
moment of resistance cm ³	$W_x = 28.0$ $W_y = 15.0$	$W_x = 63.0$ $W_y = 63.0$			
weight kg/m	$G = 4.4$	$G = 9.5$			

light				

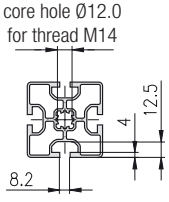
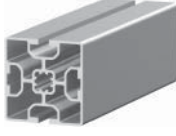
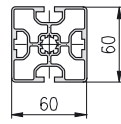
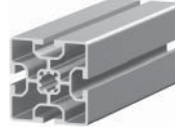
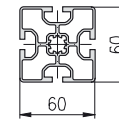

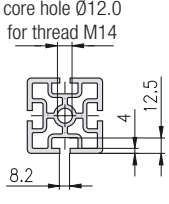
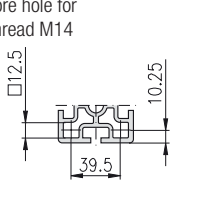
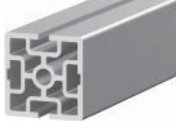
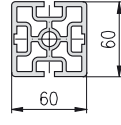
heavy			
Description	Profile 100×200, 12E, SP		
bar, 6 m	1.11.100200.124SP.60		
packing unit (number)	1.11.100200.124SP.61 (2)		
moment of inertia cm ⁴	$I_x = 2,450$ $I_y = 760$		
moment of resistance cm ³	$W_x = 250$ $W_y = 152$		
weight kg/m	$G = 17.2$		

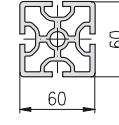



light				
	 	 		
Description	Profile 60×60, 2E, LP	Profile 60×60, 4E, LP		
bar, 6 m	1.11.060060.23LP.60	1.11.060060.43LP.60		
packing unit (number)	1.11.060060.23LP.61 (6)	1.11.060060.43LP.61 (6)		
moment of inertia cm ⁴	$I_x = 35.1$ $I_y = 37.7$	$I_x = 35.5$ $I_y = 35.5$		
moment of resistance cm ³	$W_x = 11.7$ $W_y = 12.5$	$W_x = 11.7$ $W_y = 11.7$		
weight kg/m	$G = 2.9$	$G = 2.7$		

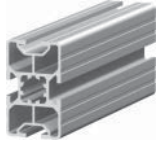
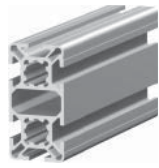
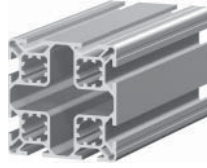

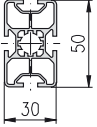
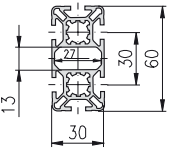
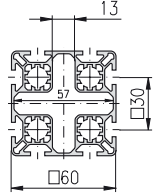
heavy				
 	 	 		
Description	Profile 60×60, 2E, SP	Profile 60×60, 4E, SP		
bar, 6 m	1.11.060060.23SP.60	1.11.060060.43SP.60		
packing unit (number)	1.11.060060.23SP.61 (6)	1.11.060060.43SP.61 (6)		
moment of inertia cm ⁴	$I_x = 55.9$ $I_y = 58.5$	$I_x = 56.0$ $I_y = 56.0$		
moment of resistance cm ³	$W_x = 18.6$ $W_y = 19.5$	$W_x = 18.7$ $W_y = 18.7$		
weight kg/m	$G = 4.3$	$G = 4.2$		

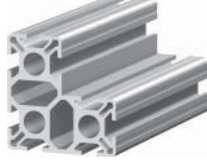

light				
Description		Profile 30×30, 2F, corner, L	Profile 30×30, 2F, L	Profile 30×30, 3F, L
bar, 6 m		1.11.030030.22L.60	1.11.030030.23L.60	1.11.030030.33L.60
packing unit (number)		1.11.030030.22L.61 (10)	1.11.030030.23L.61 (10)	1.11.030030.33L.61 (10)
moment of inertia cm ⁴		$I_x = 3.2$ $I_y = 3.2$	$I_x = 3.2$ $I_y = 3.2$	$I_x = 3.3$ $I_y = 3.2$
moment of resistance cm ³		$W_x = 2.1$ $W_y = 2.1$	$W_x = 2.2$ $W_y = 2.2$	$W_x = 2.2$ $W_y = 2.2$
weight kg/m		G = 0.9	G = 0.9	G = 0.9

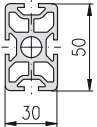
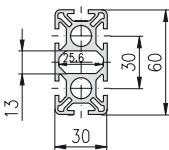
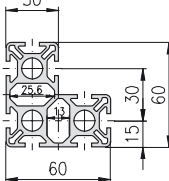
heavy					
Description		Profile 30×30, 2F, soft, S	Profile 30×30, 2F, corner, S	Profile 30×30, 2F, corner, SB	Profile 30×30, 3F, S
bar, 6 m		1.11.030030.21S.60	1.11.030030.22S.60	1.11.030030.22SB.60	1.11.030030.33S.60
packing unit (number)		1.11.030030.21S.61 (10)	1.11.030030.22S.61 (10)	1.11.030030.22SB.61 (10)	1.11.030030.33S.61 (10)
moment of inertia cm ⁴		$I_x = 2.7$ $I_y = 2.7$	$I_x = 3.7$ $I_y = 3.7$	$I_x = 3.7$ $I_y = 3.7$	$I_x = 3.5$ $I_y = 3.7$
moment of resistance cm ³		$W_x = 1.6$ $W_y = 1.6$	$W_x = 2.4$ $W_y = 2.4$	$W_x = 2.4$ $W_y = 2.4$	$W_x = 2.4$ $W_y = 2.4$
weight kg/m		G = 0.9	G = 1.1	G = 1.1	G = 1.1

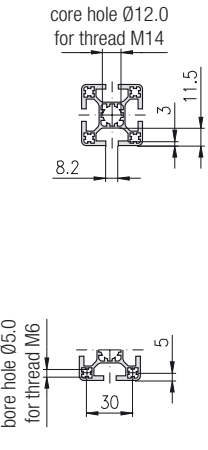
				
				
Profile 30×30, 4F, L	Profile 30×50, 4F, L	Profile 30×60, 6F, L	Profile 60×60, 8F, L	
1.11.030030.43L.60	1.11.030050.44L.60	1.11.030060.64L.60	1.11.060060.83L.60	
1.11.030030.43L.61 (10)	1.11.030050.44L.61 (6)	1.11.030060.64L.61 (6)	1.11.060060.83L.61 (8)	
$I_x = 3.3$ $I_y = 3.3$ $W_x = 2.2$ $W_y = 2.2$ $G = 0.9$	$I_x = 11.0$ $I_y = 4.3$ $W_x = 4.8$ $W_y = 3.3$ $G = 1.3$	$I_x = 21.9$ $I_y = 5.8$ $W_x = 7.4$ $W_y = 3.8$ $G = 1.6$	$I_x = 38.7$ $I_y = 38.7$ $W_x = 12.9$ $W_y = 12.9$ $G = 2.6$	

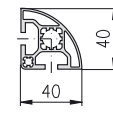
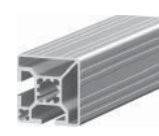
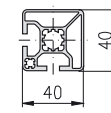
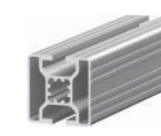
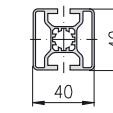
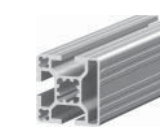
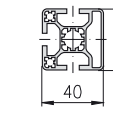
				
				
Profile 30×30, 4F, S	Profile 30×50, 4F, S	Profile 30×60, 6F, S		Profile 60×60, 8F, angle, S
1.11.030030.43S.60	1.11.030050.44S.60	1.11.030060.65S.60		1.11.060060.87S.60
1.11.030030.43S.61 (10)	1.11.030050.44S.61 (6)	1.11.030060.65S.61 (6)		1.11.060060.87S.61 (4)
$I_x = 3.5$ $I_y = 3.5$ $W_x = 2.4$ $W_y = 2.4$ $G = 1.1$	$I_x = 16.9$ $I_y = 6.6$ $W_x = 6.7$ $W_y = 4.4$ $G = 2.0$	$I_x = 25.0$ $I_y = 7.0$ $W_x = 8.3$ $W_y = 4.7$ $G = 2.1$		$I_x = 35.2$ $I_y = 35.2$ $W_x = 9.9$ $W_y = 9.9$ $G = 2.8$

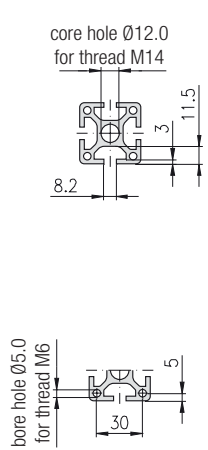
light				
	 	 	 	 
Description	Profile 40×40, 2E, soft, L	Profile 40×40, 2E, corner, L	Profile 40×40, 2E, L	Profile 40×40, 3E, L
bar, 6 m	1.11.040040.21L.60	1.11.040040.22L.60	1.11.040040.23L.60	1.11.040040.33L.60
packing unit (number)	1.11.040040.21L.61 (8)	1.11.040040.22L.61 (8)	1.11.040040.23L.61 (8)	1.11.040040.33L.61 (8)
moment of inertia cm ⁴	$I_x = 6.4$ $I_y = 6.4$	$I_x = 8.0$ $I_y = 8.0$	$I_x = 8.2$ $I_y = 7.5$	$I_x = 8.3$ $I_y = 8.8$
moment of resistance cm ³	$W_x = 3.8$ $W_y = 3.8$	$W_x = 4.0$ $W_y = 4.0$	$W_x = 4.1$ $W_y = 3.8$	$W_x = 4.1$ $W_y = 4.4$
weight kg/m	$G = 1.2$	$G = 1.3$	$G = 1.3$	$G = 1.4$

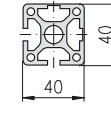
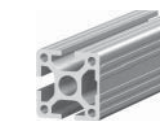
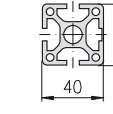
heavy				
	 	 		
Description		Profile 40×40, 2E, corner, S		Profile 40×40, 3E, S
bar, 6 m		1.11.040040.22S.60		1.11.040040.33S.60
packing unit (number)		1.11.040040.22S.61 (8)		1.11.040040.33S.61 (8)
moment of inertia cm ⁴		$I_x = 12.3$ $I_y = 12.3$		$I_x = 12.0$ $I_y = 12.3$
moment of resistance cm ³		$W_x = 6.1$ $W_y = 6.1$		$W_x = 6.0$ $W_y = 6.0$
weight kg/m		$G = 2.0$		$G = 2.0$

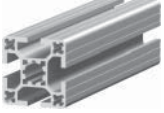
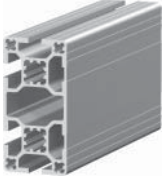
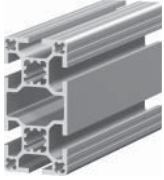
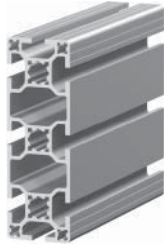
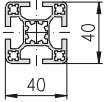
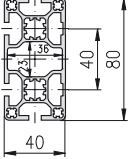
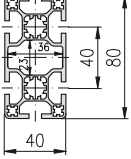
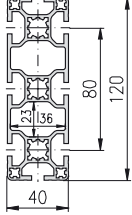
				
				
Profile 40×40, 4E, L	Profile 40×80, 4E, L	Profile 40×80, 6E, L	Profile 40×120, 8E, L	
1.11.040040.43L.60	1.11.040080.44L.60	1.11.040080.64L.60	1.11.040120.84L.60	
1.11.040040.43L.61 (8)	1.11.040080.44L.61 (4)	1.11.040080.64L.61 (4)	1.11.040120.84L.61 (2)	
$I_x = 9.9$ $I_y = 9.9$ $W_x = 4.9$ $W_y = 4.9$ $G = 1.5$	$I_x = 63.2$ $I_y = 17.8$ $W_x = 15.7$ $W_y = 8.9$ $G = 2.6$	$I_x = 62.7$ $I_y = 17.0$ $W_x = 15.6$ $W_y = 8.5$ $G = 2.6$	$I_x = 198.5$ $I_y = 25.2$ $W_x = 34.2$ $W_y = 12.6$ $G = 3.6$	

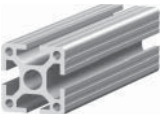
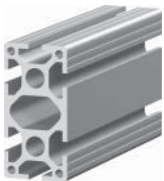
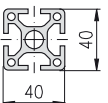
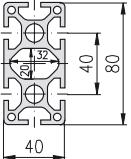
				
				
Profile 40×40, 4E, S		Profile 40×80, 6E, S		
1.11.040040.43S.60		1.11.040080.65S.60		
1.11.040040.43S.61 (8)		1.11.040080.65S.61 (4)		
$I_x = 12.0$ $I_y = 12.0$ $W_x = 6.0$ $W_y = 6.0$ $G = 2.0$		$I_x = 82.0$ $I_y = 23.4$ $W_x = 20.5$ $W_y = 11.7$ $G = 3.8$		

light				
Description	Profile 80×80, 8E, L	Profile 80×80, 8E, LB	Profile 80×160, 12E, L	
bar, 6 m	1.11.080080.83L.60	1.11.080080.83LB.60	1.11.080160.124L.60	
packing unit (number)	1.11.080080.83L.61 (2)	1.11.080080.83LB.61 (2)	1.11.080160.124L.61 (2)	
moment of inertia cm ⁴	$I_x = 111.0$ $I_y = 111.0$	$I_x = 115.0$ $I_y = 115.0$	$I_x = 801.0$ $I_y = 235.0$	
moment of resistance cm ³	$W_x = 28.0$ $W_y = 28.0$	$W_x = 29.0$ $W_y = 29.0$	$W_x = 100.0$ $W_y = 59.0$	
weight kg/m	$G = 4.1$	$G = 4.5$	$G = 8.8$	

heavy				
Description	Profile 80×80, 8E, S	Profile 80×80, 8E, angle, S	Profile 80×160, 12E, S	
bar, 6 m	1.11.080080.83S.60	1.11.080080.87S.60	1.11.080160.124S.60	
packing unit (number)	1.11.080080.83S.61 (2)	1.11.080080.87S.61 (2)	1.11.080160.124S.61 (2)	
moment of inertia cm ⁴	$I_x = 166.0$ $I_y = 166.0$	$I_x = 120.0$ $I_y = 120.0$	$I_x = 880.0$ $I_y = 268.0$	
moment of resistance cm ³	$W_x = 41.4$ $W_y = 41.4$	$W_x = 23.8$ $W_y = 23.8$	$W_x = 110.0$ $W_y = 67.0$	
weight kg/m	$G = 5.9$	$G = 5.1$	$G = 9.4$	

light					
Description	Profile 45×45, 4E, L	Profile 45×60, 4E, L	Profile 45×90, 6E, L	Profile 90×90, 8E, L	
bar, 6 m	1.11.045045.43L.60	1.11.045060.44L.60	1.11.045090.64L.60	1.11.090090.83L.60	
packing unit (number)	1.11.045045.43L.61 (8)	1.11.045060.44L.61 (6)	1.11.045090.64L.61 (4)	1.11.090090.83L.61 (2)	
moment of inertia cm ⁴	$I_x = 13.5$ $I_y = 13.5$	$I_x = 26.5$ $I_y = 16.0$	$I_x = 98.0$ $I_y = 27.5$	$I_x = 183.0$ $I_y = 183.0$	
moment of resistance cm ³	$W_x = 6.0$ $W_y = 6.0$	$W_x = 9.0$ $W_y = 7.2$	$W_x = 21.8$ $W_y = 12.2$	$W_x = 40.7$ $W_y = 40.7$	
weight kg/m	G = 1.9	G = 2.3	G = 3.3	G = 5.3	

heavy					
Description	Profile 45×45, 4E, S		Profile 45×90, 6E, S	Profile 90×90, 8E, S	
bar, 6 m	1.11.045045.43S.60		1.11.045090.64S.60	1.11.090090.83S.60	
packing unit (number)	1.11.045045.43S.61 (8)		1.11.045090.64S.61 (4)	1.11.090090.83S.61 (2)	
moment of inertia cm ⁴	$I_x = 16.8$ $I_y = 16.8$		$I_x = 126.0$ $I_y = 34.0$	$I_x = 282.0$ $I_y = 282.0$	
moment of resistance cm ³	$W_x = 7.4$ $W_y = 7.4$		$W_x = 28.0$ $W_y = 15.0$	$W_x = 63.0$ $W_y = 63.0$	
weight kg/m	G = 2.3		G = 4.4	G = 9.5	

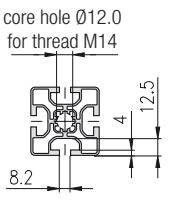
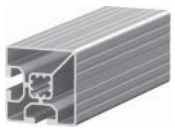
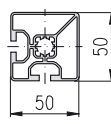
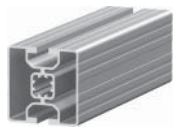
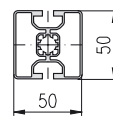
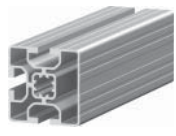
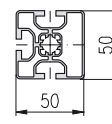
light				
		 	 	 
Description		Profile 50×50, 2E, corner, L	Profile 50×50, 2E, L	Profile 50×50, 3E, L
bar, 6 m		1.11.050050.22L.60	1.11.050050.23L.60	1.11.050050.33L.60
packing unit (number)		1.11.050050.22L.61 (6)	1.11.050050.23L.61 (6)	1.11.050050.33L.61 (6)
moment of inertia cm ⁴		$I_x = 16.5$ $I_y = 16.5$	$I_x = 17.7$ $I_y = 13.6$	$I_x = 18.4$ $I_y = 16.0$
moment of resistance cm ³		$W_x = 6.7$ $W_y = 6.7$	$W_x = 7.0$ $W_y = 5.4$	$W_x = 7.3$ $W_y = 5.8$
weight kg/m		$G = 1.7$	$G = 1.6$	$G = 1.9$

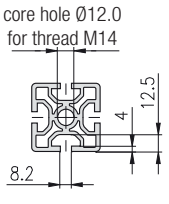
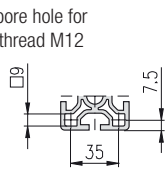
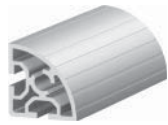
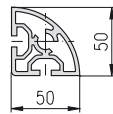
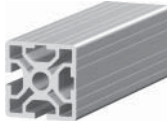
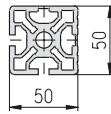
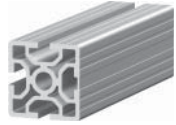
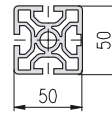
heavy				
 	 	 	 	
Description	Profile 50×50, 2E, soft, S	Profile 50×50, 2E, corner, S		Profile 50×50, 3E, S
bar, 6 m	1.11.050050.21S.60	1.11.050050.22S.60		1.11.050050.33S.60
packing unit (number)	1.11.050050.21S.61 (6)	1.11.050050.22S.61 (6)		1.11.050050.33S.61 (6)
moment of inertia cm ⁴	$I_x = 18.8$ $I_y = 18.8$	$I_x = 27.4$ $I_y = 27.4$		$I_x = 27.3$ $I_y = 28.2$
moment of resistance cm ³	$W_x = 7.5$ $W_y = 7.5$	$W_x = 10.9$ $W_y = 10.9$		$W_x = 11.1$ $W_y = 11.1$
weight kg/m	$G = 2.3$	$G = 3.0$		$G = 3.1$

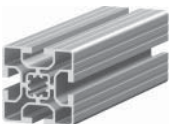
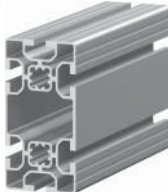
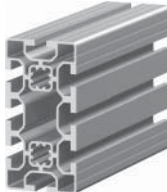
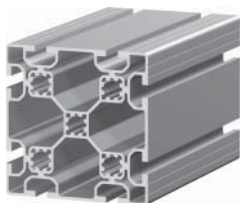
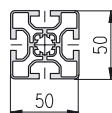
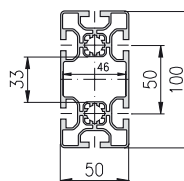
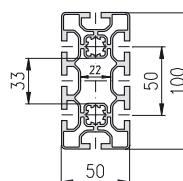
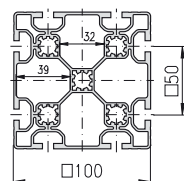
				
				
Profile 50×50, 4E, L	Profile 50×100, 6E, L	Profile 50×100, 8E, L		Profile 100×100, 8E, L
1.11.050050.43L.60	1.11.050100.64L.60	1.11.050100.84L.60		1.11.100100.83L.60
1.11.050050.43L.61 (6)	1.11.050100.64L.61 (3)	1.11.050100.84L.61 (3)		1.11.100100.83L.61 (2)
$I_x = 19.2$ $I_y = 19.2$ $W_x = 7.7$ $W_y = 7.7$ $G = 2.2$	$I_x = 138.0$ $I_y = 37.0$ $W_x = 27.5$ $W_y = 14.5$ $G = 3.5$	$I_x = 137.0$ $I_y = 40.0$ $W_x = 27.5$ $W_y = 16.0$ $G = 4.0$		$I_x = 254.1$ $I_y = 254.1$ $W_x = 45.4$ $W_y = 45.4$ $G = 6.2$

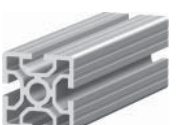
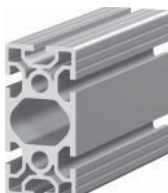
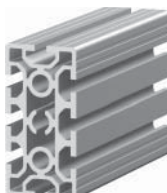
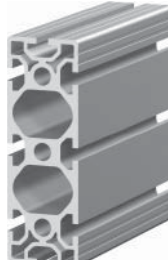
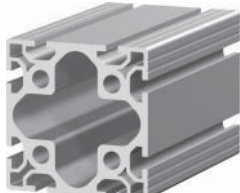
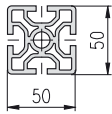
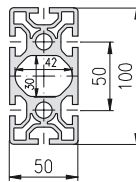
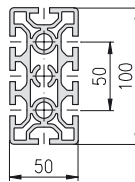
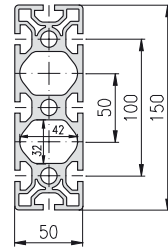
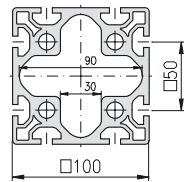
				
				
Profile 50×50, 4E, S	Profile 50×100, 6E, S	Profile 50×100, 8E, S	Profile 50×150, 8E, S	Profile 100×100, 8E, S
1.11.050050.43S.60	1.11.050100.65S.60	1.11.050100.84S.60	1.11.050150.85S.60	1.11.100100.83S.60
1.11.050050.43S.61 (6)	1.11.050100.65S.61 (3)	1.11.050100.84S.61 (3)	1.11.050150.85S.61 (2)	1.11.100100.83S.61 (2)
$I_x = 27.3$ $I_y = 27.3$ $W_x = 11.0$ $W_y = 11.0$ $G = 3.1$	$I_x = 202.0$ $I_y = 57.2$ $W_x = 40.4$ $W_y = 22.8$ $G = 5.9$	$I_x = 200.0$ $I_y = 53.3$ $W_x = 39.9$ $W_y = 21.3$ $G = 6.0$	$I_x = 628.0$ $I_y = 83.0$ $W_x = 83.0$ $W_y = 33.0$ $G = 8.1$	$I_x = 411.0$ $I_y = 411.0$ $W_x = 82.0$ $W_y = 82.0$ $G = 9.7$

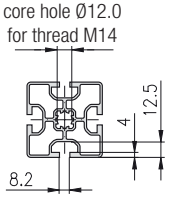
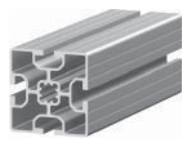
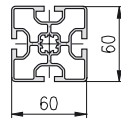
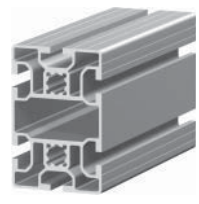
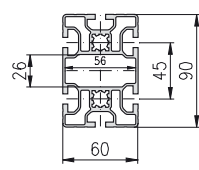

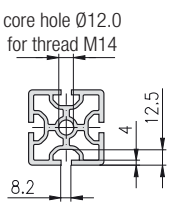
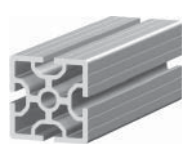
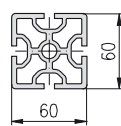
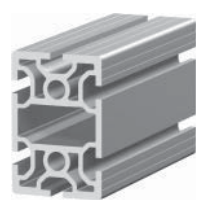
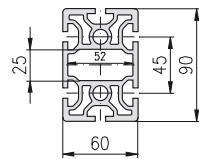

light				
	 	 		
Description	Profile 60×60, 4E, L	Profile 60×90, 6E, L		
bar, 6 m	1.11.060060.43L.60	1.11.060090.64L.60		
packing unit (number)	1.11.060060.43L.61 (6)	1.11.060090.64L.61 (3)		
moment of inertia cm ⁴	$I_x = 35.5$ $I_y = 35.5$	$I_x = 125.8$ $I_y = 54.3$		
moment of resistance cm ³	$W_x = 11.7$ $W_y = 11.7$	$W_x = 27.9$ $W_y = 18.1$		
weight kg/m	$G = 2.7$	$G = 3.9$		

heavy				
	 	 		
Description	Profile 60×60, 4E, S	Profile 60×90, 6E, S		
bar, 6 m	1.11.060060.43S.60	1.11.060090.64S.60		
packing unit (number)	1.11.060060.43S.61 (6)	1.11.060090.64S.61 (3)		
moment of inertia cm ⁴	$I_x = 56.0$ $I_y = 56.0$	$I_x = 193.0$ $I_y = 83.0$		
moment of resistance cm ³	$W_x = 18.7$ $W_y = 18.7$	$W_x = 43.0$ $W_y = 27.5$		
weight kg/m	$G = 4.2$	$G = 6.0$		

heavy					
Description	Profile 48, round, 1E, SP	Profile 48, round, 2E, corner, SP	Profile 48, round, 2E, SP		
bar, 6 m	1.11.048R00.10SP.60	1.11.048R00.22SP.60	1.11.048R00.20SP.60		
packing unit (number)	1.11.048R00.10SP.61 (6)	1.11.048R00.22SP.61 (6)	1.11.048R00.20SP.61 (6)		
moment of inertia cm ⁴	$I_x = 12.5$ $I_y = 12.9$	$I_x = 12.0$ $I_y = 12.0$	$I_x = 12.5$ $I_y = 13.5$		
moment of resistance cm ³	$W_x = 4.9$ $W_y = 5.4$	$W_x = 5.0$ $W_y = 5.0$	$W_x = 5.1$ $W_y = 5.9$		
weight kg/m	G = 1.8	G = 2.0	G = 2.0		

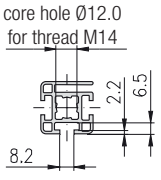
Profiles octagonal, P (plain)

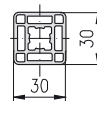
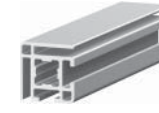
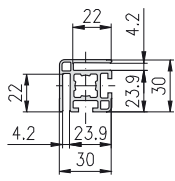
heavy					
Description	Profile 30, octagonal, 8F, SP	Profile 40, octagonal, 8E, SP			
bar, 6 m	1.11.0308kt.89SP.60	1.11.0408kt.89SP.60			
packing unit (number)	1.11.0308kt.89SP.61 (2)	1.11.0408kt.89SP.61 (2)			
moment of inertia cm ⁴	$I_x = 84.0$ $I_y = 84.0$	$I_x = 233.0$ $I_y = 233.0$			
moment of resistance cm ³	$W_x = 21.0$ $W_y = 21.0$	$W_x = 44.0$ $W_y = 44.0$			
weight kg/m	G = 3.9	G = 6.5			

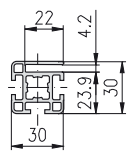
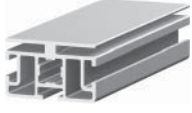
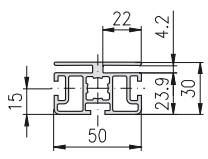
<div style="border: 1px solid black; border-radius: 10px; padding: 5px; width: fit-content; margin-bottom: 10px;">light</div> 	 	 	 	 	
	Description	Panel profile 30×30, OF, LP	Panel profile 30×30, 2F, corner, LP 4	Panel profile 30×30, 3F, LP 4	Panel profile 30×50, 3F, LP 4
	bar, 6 m	1.14.030030.03LP0.60	1.14.030030.22LP4.60	1.14.030030.33LP4.60	1.14.030050.34LP4.60
	packing unit (number)	1.14.030030.03LP0.61(10)	1.14.030030.22LP4.61(10)	1.14.030030.33LP4.61(10)	1.14.030050.34LP4.61 (6)
	moment of inertia cm ⁴ moment of resistance cm ³ weight kg/m	$I_x = 3.8$ $I_y = 3.8$ $W_x = 2.4$ $W_y = 2.4$ G = 1.1	$I_x = 3.3$ $I_y = 3.3$ $W_x = 2.2$ $W_y = 2.2$ G = 1.0	$I_x = 3.3$ $I_y = 2.8$ $W_x = 2.2$ $W_y = 1.8$ G = 0.9	$I_x = 5.5$ $I_y = 11.8$ $W_x = 3.6$ $W_y = 4.8$ G = 1.5

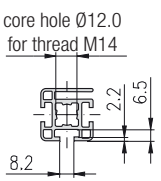
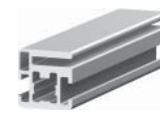
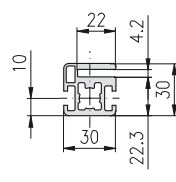
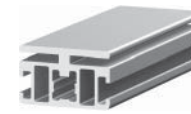
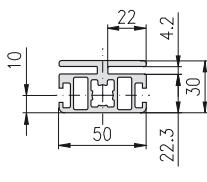
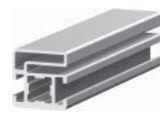
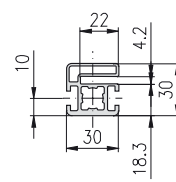
<div style="border: 1px solid black; border-radius: 10px; padding: 5px; width: fit-content; margin-bottom: 10px;">light</div> 	 	 	 	
	Description	Panel profile 30×30, 2F, LP 5	Panel profile 30×50, 2F, LP 5	Panel profile 30×30, 2F, LP 6
	bar, 6 m	1.14.030030.23LP5.60	1.14.030050.24LP5.60	1.14.030030.23LP6.60
	packing unit (number)	1.14.030030.23LP5.61(10)	1.14.030050.24LP5.61(10)	1.14.030030.23LP6.61 (6)
	moment of inertia cm ⁴ moment of resistance cm ³ weight kg/m	$I_x = 4.3$ $I_y = 3.3$ $W_x = 2.8$ $W_y = 2.2$ G = 1.2	$I_x = 7.0$ $I_y = 14.7$ $W_x = 4.7$ $W_y = 5.9$ G = 1.9	$I_x = 3.6$ $I_y = 2.8$ $W_x = 2.4$ $W_y = 1.9$ G = 1.0

<p>light</p>					
	Description	Panel profile 40×40, 2E, corner, LP 4	Panel profile 40×40, 3E, LP 4	Panel profile 40×60, 3E, LP 4	Panel profile 60×80, 5E, LP 4
	bar, 6 m	1.14.040040.22LP4.60	1.14.040040.33LP4.60	1.14.040060.34LP4.60	1.14.060080.54LP4.60
	packing unit (number)	1.14.040040.22LP4.61 (8)	1.14.040040.33LP4.61 (8)	1.14.040060.34LP4.61 (8)	1.14.060080.54LP4.61 (4)
moment of inertia cm ⁴	$I_x = 10.3$ $I_y = 10.3$	$I_x = 10.2$ $I_y = 8.7$	$I_x = 14.8$ $I_y = 26.3$	$I_x = 100.4$ $I_y = 50.4$	
moment of resistance cm ³	$W_x = 5.2$ $W_y = 5.2$	$W_x = 5.1$ $W_y = 4.3$	$W_x = 7.4$ $W_y = 8.8$	$W_x = 25.1$ $W_y = 16.8$	
weight kg/m	G = 1.8	G = 1.65	G = 2.4	G = 3.8	

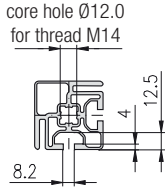
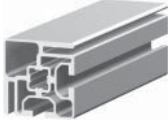
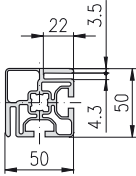
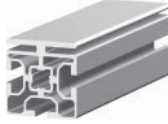
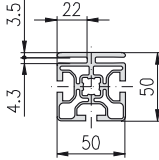

<p>light</p>	Profile for door stop				
	Description	Panel profile 60×80, 6E, LP 4	Profile 20×30, 1F, LP	Assembly drawing	Assembly drawing
	bar, 6 m	1.14.060080.64LP4.60	1.11.020030.14LP.60		
packing unit (number)	1.14.060080.64LP4.61 (4)	1.11.020030.14LP.61 (10)			
moment of inertia cm ⁴	$I_x = 88.1$ $I_y = 52.0$	$I_x = 2.2$ $I_y = 1.4$	$I_x = 113.0$ $I_y = 64.0$	$I_x = 89.2$ $I_y = 53.3$	
moment of resistance cm ³	$W_x = 22.1$ $W_y = 17.3$	$W_x = 1.5$ $W_y = 1.4$	$W_x = 28.5$ $W_y = 21.3$	$W_x = 22.3$ $W_y = 17.7$	
weight kg/m	G = 3.7	G = 0.7	G = 4.5	G = 4.4	

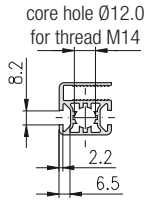
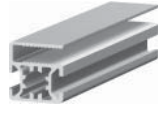
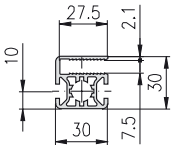
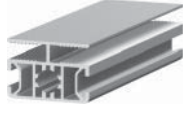
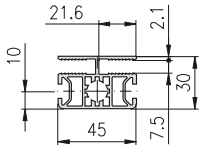
<p style="text-align: center;">light</p> 	 	 		
Description	Panel profile 50×50, 2E, corner, LP 4	Panel profile 50×50, 3E, LP 4		
bar, 6 m	1.14.050050.22LP4.60	1.14.050050.39LP4.60		
packing unit (number)	1.14.050050.22LP4.61 (6)	1.14.050050.39LP4.61 (6)		
moment of inertia cm ⁴ moment of resistance cm ³ weight kg/m	$I_x = 19.4$ $I_y = 19.4$ $W_x = 7.6$ $W_y = 7.6$ $G = 2.4$	$I_x = 24.1$ $I_y = 21.4$ $W_x = 8.0$ $W_y = 8.5$ $G = 2.7$		



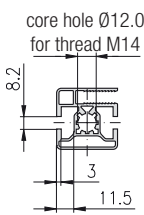
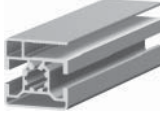
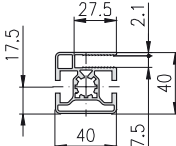
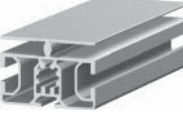
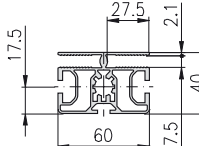

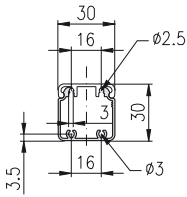

light				
	 	 		
Description	Wire net profile 30×30, 2F, LP 7.5	Wire net profile 30×45, 2F, LP 7.5		
bar, 6 m	1.15.030030.23LP7.60	1.15.030045.24LP7.60		
packing unit (number)	1.15.030030.23LP7.61(10)	1.15.030045.24LP7.61 (8)		
moment of inertia cm ⁴	$I_x = 2.6$ $I_y = 3.2$	$I_x = 4.3$ $I_y = 7.4$		
moment of resistance cm ³	$W_x = 1.7$ $W_y = 2.1$	$W_x = 2.9$ $W_y = 3.3$		
weight kg/m	$G = 0.86$	$G = 1.15$		

Wire net profiles 40, F / E3-slot, P (plain)

light				
	 	 		
Description	Wire net profile 40×40, 2E, LP 7.5	Wire net profile 40×60, 2E, 1F, LP 7.5		
bar, 6 m	1.15.040040.23LP7.60	1.15.040060.34LP7.60		
packing unit (number)	1.15.040040.23LP7.61 (8)	1.15.040060.34LP7.61 (8)		
moment of inertia cm ⁴	$I_x = 7.5$ $I_y = 8.2$	$I_x = 12.2$ $I_y = 22.5$		
moment of resistance cm ³	$W_x = 3.8$ $W_y = 4.1$	$W_x = 6.1$ $W_y = 7.5$		
weight kg/m	$G = 1.35$	$G = 1.97$		

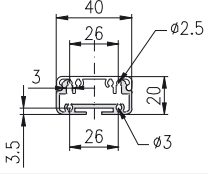
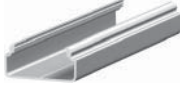
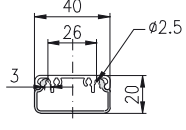

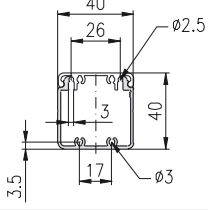

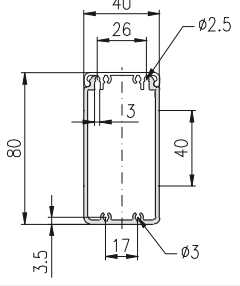
Cover profile 30			Description	E-trunking profile, lid 30	
			bar, 6 m	1.19.2030D.60	
			packing unit (number)	1.19.2030D.61 (8)	
			cut to length	1.19.2030D-A00A00/...	
			weight kg/m	G = 0.24	
Base profiles 30	 				
			Description		E-trunking profile 30×30
			bar, 6 m		1.19.203030G.60
			packing unit (number)		1.19.203030G.61 (8)
			cut to length		1.19.203030G-A00A00/...
weight kg/m		G = 0.38			
Technical data					
material: Al Mg Si 0.5 F25					
tensile strength: 250 N/mm ²					
surface: natural anodised					

End plates  318



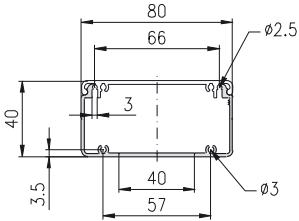

Cover profile 40					Description	E-trunking profile, lid 40
					bar, 6 m	1.19.2040D.60
					packing unit (number)	1.19.2040D.61 (8)
					cut to length	1.19.2040D-A00A00/...
					weight kg/m	G = 0.35
Base profiles 40	 	 	 	 		
	Description		E-trunking profile 40×20, for clips	E-trunking profile 40×20	E-trunking profile 40×40	E-trunking profile 40×80
	bar, 6 m		1.19.214020G.60	1.19.204020G.60	1.19.204040G.60	1.19.204080G.60
	packing unit (number)		1.19.214020G.61 (16)	1.19.204020G.61 (16)	1.19.204040G.61 (8)	1.19.204080G.61 (4)
	cut to length		1.19.214020G-A00A00/...	1.19.204020G-A00A00/...	1.19.204040G-A00A00/...	1.19.204080G-F00F00/...
weight kg/m		G = 0.50	G = 0.30	G = 0.61	G = 1.24	
Technical data						
material: Al Mg Si 0.5 F25						
tensile strength: 250 N/mm ²						
surface: natural anodised						

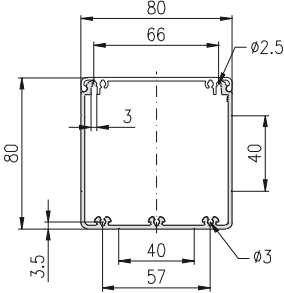
End plates  318

(/... = Length in mm)

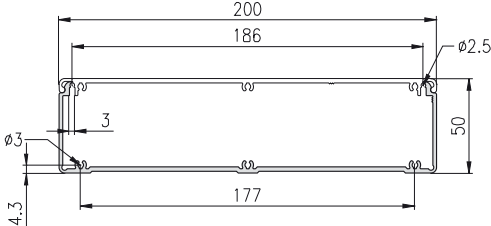

Cover profile 80		Description	E-trunking profile, lid 80
		bar, 6 m	1.19.2080D.60
Base profiles 80	 	packing unit (number)	1.19.2080D.61 (4)
		cut to length	1.19.2080D-F00F00/...
		weight kg/m	G = 0.59
	 		
Description	E-trunking profile 80×40	E-trunking profile 80×80	
bar, 6 m	1.19.208040G.60	1.19.208080G.60	
packing unit (number)	1.19.208040G.61 (4)	1.19.208080G.61 (2)	
cut to length	1.19.208040G-F00F00/...	1.19.208080G-F00F00/...	
weight kg/m	G = 1.20	G = 1.55	

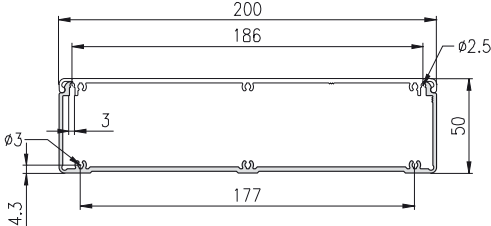
End plates  318

Cover profile 200		Description	E-trunking profile, lid 200
		bar, 6 m	1.19.2200D.60
Base profile 200	 	packing unit (number)	1.19.2200D.61 (2)
		cut to length	1.19.2200D-L00L00/...
		weight kg/m	G = 1.50
	 		
Description	E-trunking profile 200×50		
bar, 6 m	1.19.220050G.60		
packing unit (number)	1.19.220050G.61 (2)		
cut to length	1.19.220050G-L00L00/...		
weight kg/m	G = 2.00		

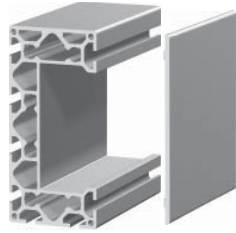
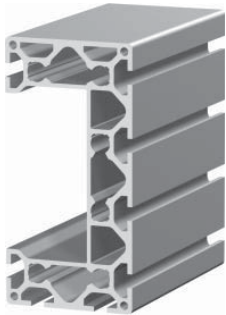
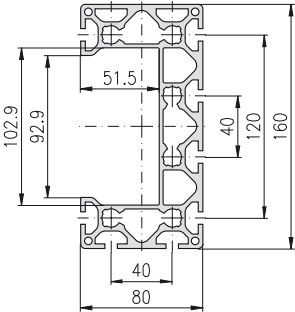

End plates  318

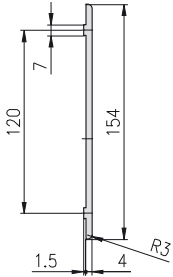
(/... = Length in mm)

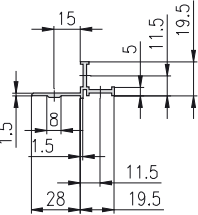
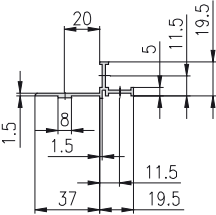
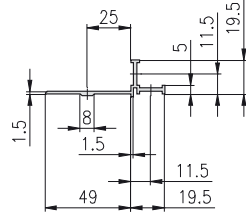



E-trunking profile 160 	Base profile: Profile 80×160, 8E, SP \rightarrow 25, 316-319		Cover profile: Profile pre-cut lid 120 \rightarrow 52, 316-319	
	 			 
Technical data material: Al Mg Si 0.5 F25 tensile strength: 250 N/mm ² surface: natural anodised				
Description	Profile 80×160, 8E, SP		Profile pre-cut lid 120	
bar, 6 m	1.11.080160.89SP.60		1.19.1101120.60	
packing unit (number)	1.11.080160.89SP.61 (2)		1.19.1101120-L00L00/... (cut to length)	
moment of inertia cm ⁴	$I_x = 944.0$ $I_y = 183.0$			
moment of resistance cm ³	$W_x = 118.0$ $W_y = 45.8$			
weight kg/m	$G = 7.9$		$G = 1.80$	

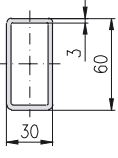
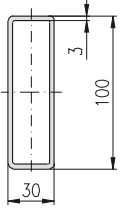



19" profiles 				
				
Technical data material: Al Mg Si 0.5 F25 tensile strength: 250 N/mm ² surface: natural anodised				
Description	19" profile, PG 30	19" profile, PG 40	19" profile, PG 50	
bar, 6 m	1.19.19030.60	1.19.19040.60	1.19.19050.60	
cut to length	1.19.19030-A00A00/...	1.19.19040-A00A00/...	1.19.19050-A00A00/...	
weight kg/m	$G = 0.4$	$G = 0.45$	$G = 0.5$	

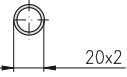
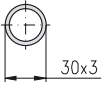

(... = Length in mm); machining data \rightarrow Profile machining 1.1A



light				
				
				
Description	Tube profile 30×60, LP	Tube profile 30×100, LP		
bar, 6 m	1.17.030060.04LP.60	1.17.030100.04LP.60		
packing unit (number)	1.17.030060.04LP.61 (6)	1.17.030100.04LP.61 (4)		
moment of inertia cm ⁴	$I_x = 24.0$	$I_y = 7.5$	$I_x = 90.0$	$I_y = 12.0$
moment of resistance cm ³	$W_x = 8.0$	$W_y = 5.0$	$W_x = 18.0$	$W_y = 8.0$
weight kg/m	$G = 1.47$	$G = 2.20$		

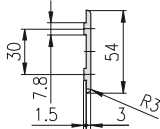
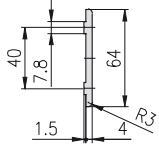
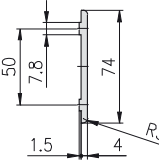
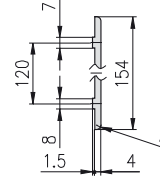

Tubes

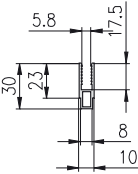
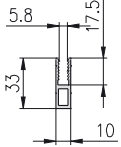
Tubes				
				
Technical data				
material:	Al Mg Si 0.5 F22			
tensile strength:	220 N/mm ²			
surface:	natural anodised			
Description	Tube Ø20×2	Tube Ø30×3	Tube Ø40×4	
bar, 6 m	1.19.16120.60	1.19.16130.60	1.19.16140.60	
cut to length	1.19.16120-A00A00/...	1.19.16130-A00A00/...	1.19.16140-A00A00/...	
weight kg/m	$G = 0.3$	$G = 0.7$	$G = 1.3$	

Profile pre-cut lids					Application E-trunking profiles, 50, 316-319
Technical data material: Al Mg Si 0.5 F25 tensile strength: 250 N/mm ² surface: natural anodised					
Description	Profile pre-cut lid 30	Profile pre-cut lid 40	Profile pre-cut lid 50	Profile pre-cut lid 120	
bar, 6 m	1.19.110130.60	1.19.110140.60	1.19.110150.60	1.19.110120.60	
cut to length	1.19.110130-A00A00/...	1.19.110140-A00A00/...	1.19.110150-F00F00/...	1.19.110120-L00L00/...	
weight kg/m	G = 0.49	G = 0.74	G = 0.85	G = 1.80	

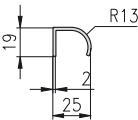
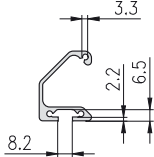
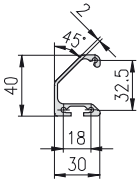
Wire net mounting profiles				
Technical data material: Al Mg Si 0.5 F25 tensile strength: 250 N/mm ² surface: natural anodised				
Description	Wire net mounting profile	Wire net mounting profile 33×10		
bar, 6 m	1.19.14230.60	1.19.1423310.60		
cut to length	1.19.14230-A00A00/...	1.19.1423310-A00A00/...		
weight kg/m	G = 0.3	G = 0.4		

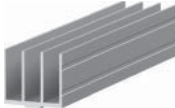
Grab handle profiles				F-slot 
Technical data material: Al Mg Si 0.5 F25 tensile strength: 250 N/mm ² surface: natural anodised				
Description	Grab handle profile			Grab handle profile
bar, 6 m	1.19.14319.60			1.19.14330.60
cut to length	1.19.14319-A00A00/...			1.19.14330-A00A00/...
weight kg/m	G = 0.3			G = 0.73

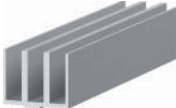
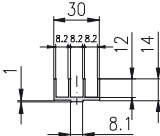
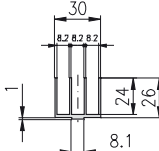
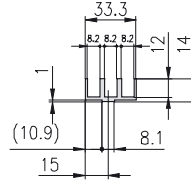
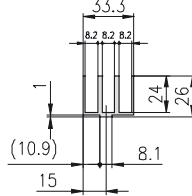
Sliding profiles					
Technical data material: Al Mg Si 0.5 F25 tensile strength: 250 N/mm ² surface: natural anodised					
Description		Sliding profile 30×14	Sliding profile 30×26	Sliding profile 33×14	Sliding profile 33×26
bar, 6 m		1.19.15130.60	1.19.15131.60	1.19.15133.60	1.19.15134.60
cut to length		1.19.15130-A00A00/...	1.19.15131-A00A00/...	1.19.15133-A00A00/...	1.19.15134-A00A00/...
weight	kg/m	G = 0.4	G = 0.6	G = 0.5	G = 0.8

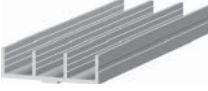
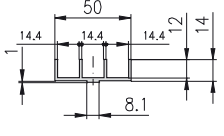
Sliding profile					
Technical data material: Al Mg Si 0.5 F25 tensile strength: 250 N/mm ² surface: natural anodised					
Description		Sliding profile 50×14			
bar, 6 m		1.19.15150.60			
cut to length		1.19.15150-A00A00/...			
weight	kg/m	G = 0.6			

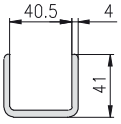
U-profile		
Technical data material: Al Mg Si 0.5 F25 tensile strength: 250 N/mm ² surface: natural anodised		
Description		U-profile 40
bar, 6 m		1.19.14440.60
cut to length		1.19.14440-A00A00/...
weight	kg/m	G = 1.35

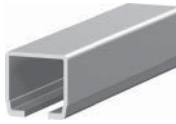
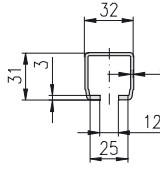
C-track		
Technical data material: Al Mg Si 0.5 F25 tensile strength: 250 N/mm ² surface: natural anodised		
Description		C-track
bar, 6 m		1.19.14532.60
cut to length		1.19.14532-A00A00/...
weight	kg/m	G = 0.6

Summary

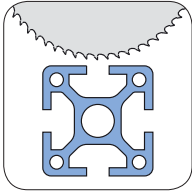

Saw cut

↔ 55

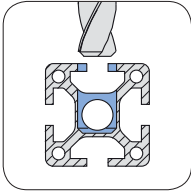

Cross bushing bores for connectors

↔ 56

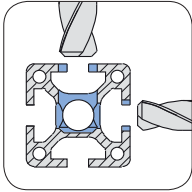

Bores for parallel-connector

↔ 56

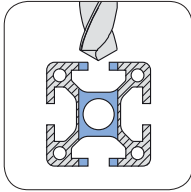

Cross bore

↔ 56

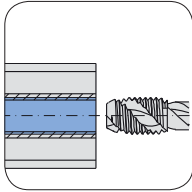

Thread

↔ 56

Comments

- Profile machinings are defined by the article-number of the profile.
- For more complex machinings, additional order descriptions are needed.
- Non-standard machinings will be completed as per drawings

Order description

Profile	machining	profile side	
	left right		
Order-No.: 1.□□.□□□□□□.□□□□ -	□□□□□□ / □□□□		
	□□□□□□ / □□□□	saw cut	↔ 55
	□□□□□□ / □□□□	cross bushing bores, bores for parallel-connector, cross bore, thread	↔ 56
	□□□□□□ / □□□□	direction	↔ 57
	□□□□□□ / □□□□	length in mm	

Order example

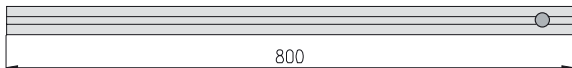

Description Profile 40×40, 4E-slots, S Length: 800 mm right side: 1 connector bore	Article-No. 1.11.040040.43S-A00AA4/800	Article-Description Profile 40×40, 4E-slots, S □□□□ Specifications for special profile machining
--	--	---

coding examples ↔ 1.1B

Saw cut

Saw cut tolerance: ± 0.1 mm

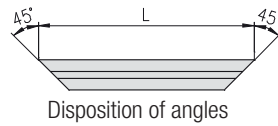
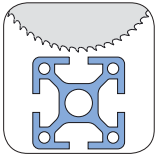

Cut is right view

- For angle cuts specify the absolute length
- Angle cuts without specification = 45°

Specification for special angle:

Special angle, left: °

Special angle, right: °

Price group 1

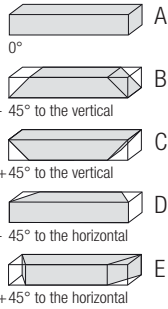

16	16x40	1F	1E	20	20x10	1F LP	20x30	1F LP	2F LP															
20	20x20	2H soft	2H c.	2H	3H	4H	20x40	4H	6H	8H														
30	30x30	2F soft	0F	1F	2F c.	2F c. B	2F	3F	4F	30x50	4F	30x60	0F	6F	30x30	0F	2F c.	2F	30x60	30x30	0F	2F c.	2F	30x60
40	40x40	2E soft	0E	1E	2E c.	2E	3E	4E	40 r.30°	40 r.45°	40x40	2E	2E 45°	40x40	2E c.	3E	2E							
45	45x45	2E soft	0E	1E	2E c.	2E	3E	4E	48 round	1E	2E c.	2E												
50	50x50	2E soft	2E c.	2E	3E	4E	50x50	2E c.	3E															

Price group 2

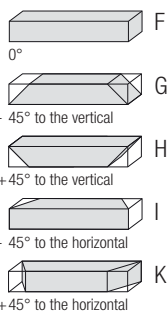

16	16x80	2E	30	30x100	5E	2F	8F	10F	60x60	8F	8F angle	30x100		
40	40x80	0E	3E c.	4E	4E B	5E	6E	8E	40 r.60°	2E	40x60	40x60	2E 1F	3E
45	45x60	4E	0E	6E	50	50x100	6E	8E	60x60	2E	4E	60x80	5E	6E

Price group 3

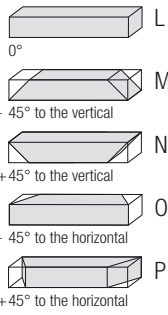

16	16x160	4E	30	30x150	8F	8E	40	40x160	6E	10E	80x120	10E	8E	8E	12E	40 r.90°	2E
40	80x80	0E	4E c.	6E	7E	8E	8E B	8E angle	7E 45°	120x120	12E						
45	90x90	8E	50	50x150	8E	100x100	8E	100x200	12E	60	60x90	6E	30 octag.	40 octag.	8F	8E	

1

Cross bushing bore for connector

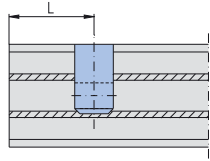
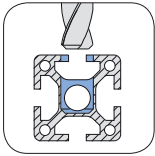

number of bores

- 1 = A 6 = F
- 2 = B 7 = G
- 3 = C 8 = H
- 4 = D 9 = I
- 5 = E 10 = K
- 0 = without machining

Disposition rule for connectors at opposed profile sides		
Specified Direction	Position of bore	Example
1	Side 1 and Side 3	
2	Side 2 and Side 4	

Specification for special position:

Position for cross bushing bore, left: ...

Position for cross bushing bore, right: ...

initials (per 57, „Direction and Position“)

Bores for parallel-connector

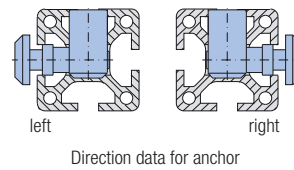
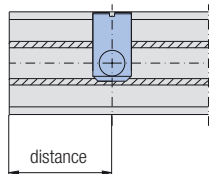
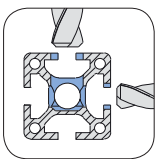

Parallel-connector = Z
without machining = 0

Specification for parallel-connector:

text **distance** **direction**

Parallel-connector, distance left: mm, anchor left / right

Parallel-connector, distance right: mm, anchor left / right

Cross bore

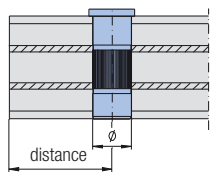
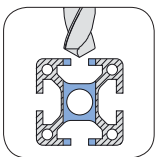

Cross bore = Q
without machining = 0

Specification for cross bore:

Cross bore, left: Ø mm, distance mm

Cross bore, right: Ø mm, distance mm

Thread

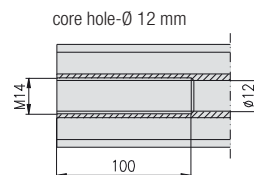
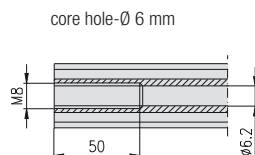
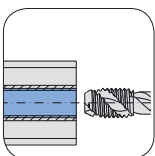

number of threads

- 1 = L 6 = S
- 2 = M 7 = T
- 3 = N 8 = U
- 4 = P 9 = V
- 5 = R 10 = W
- 0 = without machining

Specification for special thread designs:

Depth of thread, left: ... mm

Depth of thread, right: ... mm

Position of thread, left: ...

Position of thread, right: ...

small letters (per 57, „Direction and Position“)



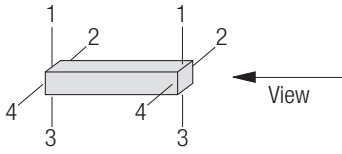





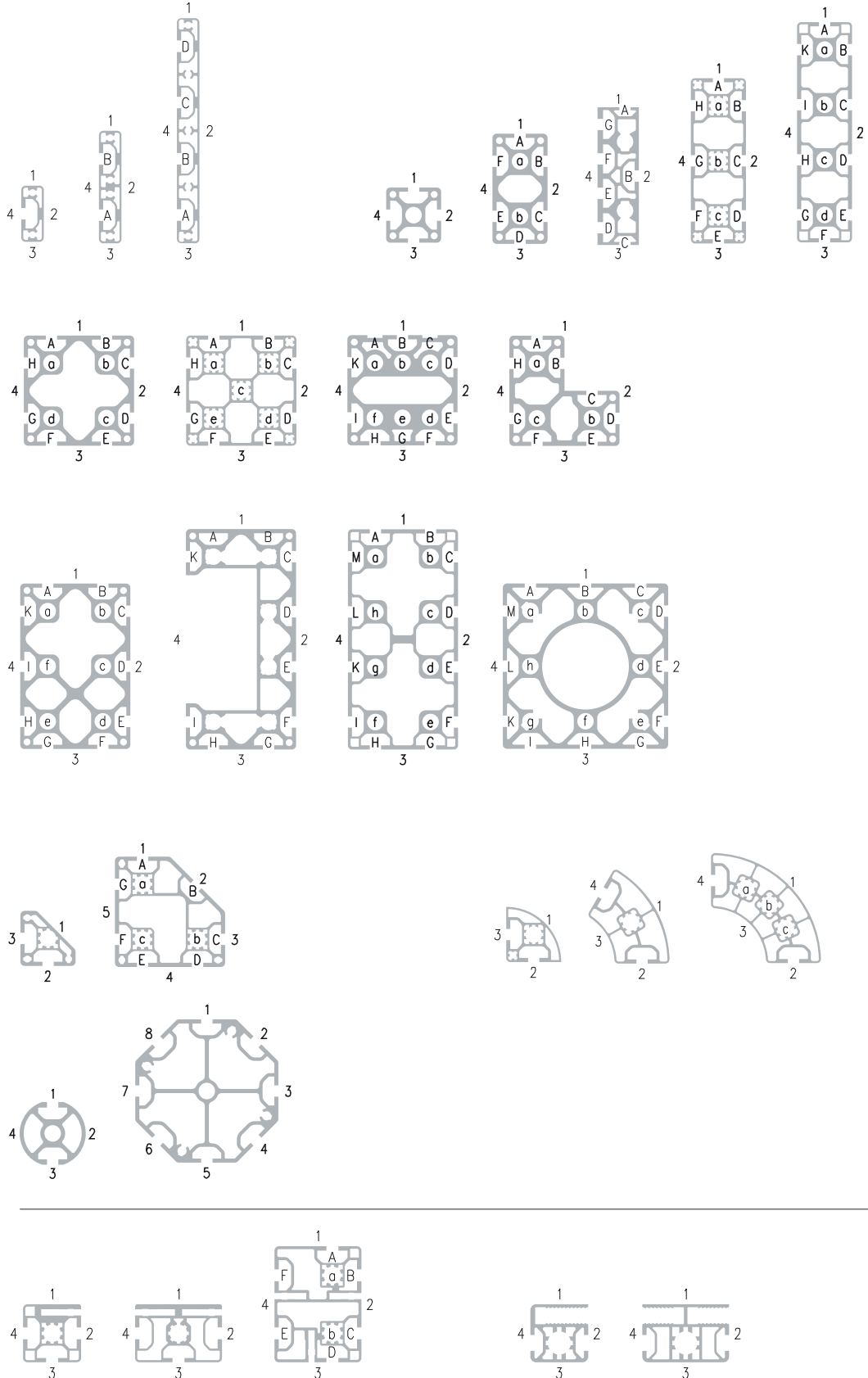







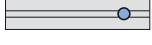









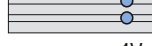
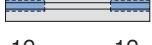
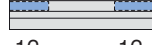
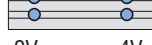
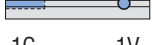





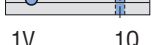
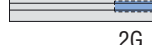
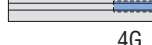



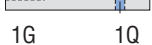



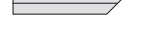

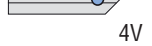

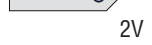

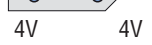





Direction and Position









































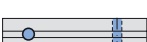









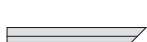







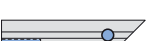

Description

Direction: 1 - 4
 Position of slot: A - M
 Position of thread: a - h



Coding examples for price group 1			
			
 -A00A00	 -A00A00		 -A00A00
 -A00AA4 1V	 -A00AB4 2V	 -A00AB1 2V	 -A00AB4 2V
 -AA4AA4 1V 1V	 -AB4AB4 2V 2V	 -AB1AB1 2V 2V	 -AB4AB4 2V 2V
 -A00AL0 1G	 -A00AL0 1G		 -A00AD2 4V
 -AL0AL0 1G 1G	 -AL0AL0 1G 1G		 -AB4AD2 2V 4V
 -AL0AA4 1G 1V	 -AL0AB4 1G 2V	 -AL0AB1 1G 2V	 -AD2AD2 4V 4V
 -A00AQ1 1Q	 -AM0AB4 2G 2V	 -AM0AB1 2G 2V	 -AP0AD2 4G 4V
 -AA4AQ1 1V 1Q	 -A00AM0 2G		 -A00AP0 4G
 -AQ1AQ1 1Q 1Q	 -AM0AM0 2G 2G		 -AP0AP0 4G 4G
 -AL0AQ1 1G 1Q	 -AL0AM0 1G 2G		 -A00C00
 -A00C00	 -A00C00	top view  -A00E00	 -A00CD2 4V
 -A00CA4 1V	 -A00CB4 2V	 -A00EB1 2V	 -AD2CD2 4V 4V
 -AA4CA4 1V 1V	 -AB4CB4 2V 2V	 -AB1EB1 2V 2V	 -AD1CD1 4V 4V
 -AL0CA4 1G 1V	 -AL0CB4 1G 2V	 -AL0EB1 1G 2V	 -C00C00
 -C00C00	 -C00C00	 -E00E00	 -CD2CD2 4V 4V
 -CA4CA4 1V 1V	 -CB4CB4 2V 2V	 -EB1EB1 2V 2V	 -CD1CD1 4V 4V

















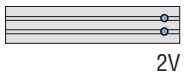
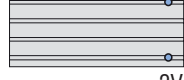

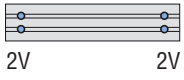
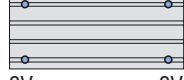
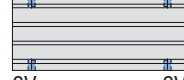
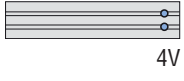
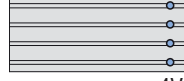
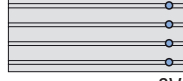
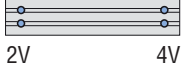

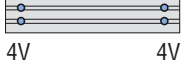
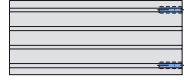
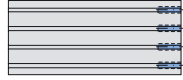
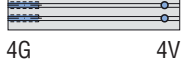
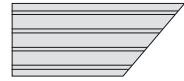
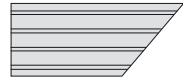
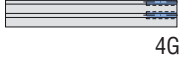
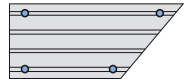
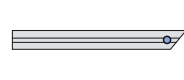
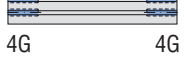
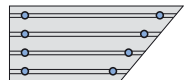
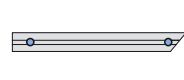
V = connector bore, G = thread, Q = cross bore

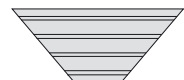
Coding examples for price group 2			
	 		
 -F00F00	 -F00F00		 -F00F00
 -F00FA4 1V	 -F00FB4 2V	 -F00FB1 2V	 -F00FB4 2V
 -FA4FA4 1V 1V	 -FB4FB4 2V 2V	 -FB1FB1 2V 2V	 -FB4FB4 2V 2V
 -F00FLO 1G	 -F00FLO 1G		 -F00FD2 4V
 -FLOFLO 1G 1G	 -FLOFLO 1G 1G		 -FB4FD2 2V 4V
 -FLOFA4 1G 1V	 -FLOFB4 1G 2V	 -FLOFB1 1G 2V	 -FD2FD2 4V 4V
 -F00FQ1 1Q	 -FM0FB4 2G 2V	 -FM0FB1 2G 2V	 -FP0FD2 4G 4V
 -FA4FQ1 1V 1Q	 -F00FM0 2G		 -F00FP0 4G
 -FQ1FQ1 1Q 1Q	 -FM0FM0 2G 2G		 -FP0FP0 4G 4G
 -FLOFQ1 1G 1Q	 -FLOFM0 1G 2G		 -F00H00
 -F00H00	 -F00H00	top view  -F00K00	 -F00HD2 4V
 -F00HA4 1V	 -F00HB4 2V	 -F00KB1 2V	 -FD2HD2 4V 4V
 -FA4HA4 1V 1V	 -FB4HB4 2V 2V	 -FB1KB1 2V 2V	 -FD1HD1 4V 4V
 -FLOHA4 1G 1V	 -FLOHB4 1G 2V	 -FLOKB1 1G 2V	 -H00H00
 -H00H00	 -H00H00	 -K00K00	 -HD2HD2 4V 4V
 -HA4HA4 1V 1V	 -HB4HB4 2V 2V	 -KB1KB1 2V 2V	 -HD1HD1 4V 4V

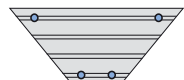
V = connector bore, G = thread, Q = cross bore

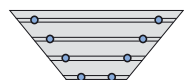
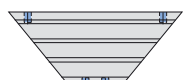
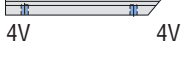
1

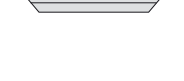
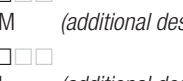
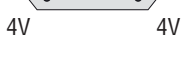
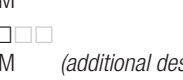
Coding examples for price group 3

		
 -L00L00	 -L00L00	 -L00L00
 -L00LB4 2V	 -L00LB4 2V	 -L00LB1 2V
 -LB4LB4 2V 2V	 -LB4LB4 2V 2V	 -LB1LB1 2V 2V
 -L00LD2 4V	 -L00LD4 4V	 -L00LH2 8V
 -LB4LD2 2V 4V	 -LD4LD4 4V 4V	 -LH2LH2 8V 8V
 -LD2LD2 4V 4V	 -L00LM0 2G	 -L00LU0 8G
 -LP0LD2 4G 4V	 -L00N00	 -L00N00
 -L00LP0 4G	 -LB4NB4 2V 2V	 -L00PB1 2V
 -LP0LP0 4G 4G	 -LD4ND4 4V 4V	 -LB1PB1 2V 2V
 -L00N00	 -N00N00	 -P00P00
 -LL0ND2 1G 4V	 -NB4NB4 2V 2V	 -PB1PB1 2V 2V
 -LD2ND2 4V 4V	 -ND4ND4 4V 4V	 -L00ND2 4V 4V
 -LD1ND1 4V 4V		 -LH2NH2 8V 8V
 -N00N00		 -N00N00
 -ND2ND2 4V 4V		 -ND1ND1 4V 4V
 -ND1ND1 4V 4V		

Order examples for special design

Article-No.	Description
① 1.11.□□□□□□.□□□□□□ -L00LD2	Profile □□□×□□□.□□□□□□ Connector position, right: CFIM (additional description)
② 1.11.□□□□□□.□□□□□□ -LD2LD2	Profile □□□×□□□.□□□□□□ Connector position, left: CFIM (additional description) Connector position, right: CFIM
③ 1.11.□□□□□□.□□□□□□ -L00ND2	Profile □□□×□□□.□□□□□□ Connector position, right: CFIM (additional description)
④ 1.11.□□□□□□.□□□□□□ -ND2ND2	Profile □□□×□□□.□□□□□□ Connector position, left: CFIM (additional description) Connector position, right: CFIM

V = connector bore, G = thread, Q = cross bore

Extruded profile
as per DIN EN 12020
 (fine)
 (Replacement for DIN 17615)

Aluminium alloy Al Mg Si 0.5 F25
 Material Nr. 3.3206.72 (low temp. annealed)

Functional length: 6,000 mm
Delivery length: 6,060 mm + 10 mm

Mechanical data

(Values given in the direction of the press flow)
 Tensile strength Rm: min. 250 N/mm²
 Elongation 0.2: min. 200 N/mm²
 Pressure tension $\sigma_{zul.}$: 95 N/mm²
 Stress point A₅: min. 10 %
 Stress point A₁₀: min. 8 %
 E-Module: approx. 70,000 N/mm²
 Brinell hardness: approx. 75 HB 2.5/187.5
 Co-efficient of elongation: 23.8 x 10⁻⁶/K

Surface as per DIN 17611:
 E6/EV1 - dull finish and anodised colours
 Coat thickness approx. 10 μ m
 Coat hardness 250-350 HV
 Special colours upon request.
 The surface area - subject to technical procedure
 - can show optical changes.

Profile tolerance
 (Excerpt from DIN EN 12020-2)

Nominal dimensions:
 The dimension deviation depends on the precision with which the tooling is manufactured, the tooling wear and the variation during the extrusion process. For one manufacturing setup the variation within one profile is 0.01 mm.

Profile tolerance		
Dim. range in mm		Tolerance in mm
from	to	
-	10	± 0.15
10	15	± 0.20
15	30	± 0.25
30	45	± 0.30
45	60	± 0.40
60	90	± 0.45
90	120	± 0.60
120	150	± 0.80
150	180	± 1.00
180	240	± 1.20
240	300	± 1.50

Flatness of profile surfaces

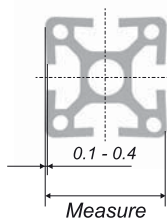

In order to optimize the connection stability, all profile surfaces are designed and manufactured with concave surfaces. This assures that the assembled profiles contact on the outer edges only (line of contact).
 When tightening the connectors the slot flanks will be drawn to the mounting profile within the elastic range and will keep the connectors under tension.

Straightness tolerance
 of the edge in longitudinal direction

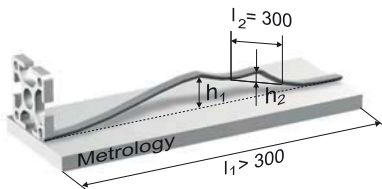

At a certain length l_1 the given tolerance h_1 is not to be exceeded.
 For each incremental length of $l_2 = 300$ mm the deviation h_2 is not to exceed 0.3 mm.

Straightness tolerance		
Length l_1 in m		Tolerance h_1 in mm
from	to	
-	1	0.7
1	2	1.3
2	3	1.8
3	4	2.2
4	5	2.6
5	6	3.0

Flatness tolerance
 (Twist tolerance)

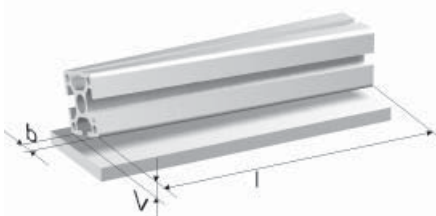

Width b in mm		Flatness tolerance					
Dim. range		at length l in m					
from	to	to 1	1 to 2	2 to 3	3 to 4	4 to 5	5 to 6
-	25	1.0	1.5	1.5	2.0	2.0	2.0
25	50	1.0	1.2	1.5	1.8	2.0	2.0
50	75	1.0	1.2	1.2	1.5	2.0	2.0
75	100	1.0	1.2	1.5	2.0	2.2	2.5
100	125	1.0	1.5	1.8	2.2	2.5	3.0
125	150	1.2	1.5	1.8	2.2	2.5	3.0
150	200	1.5	1.8	2.2	2.6	3.0	3.5
200	300	1.8	2.5	3.0	3.5	4.0	4.5

Parallelism tolerance
(Angular tolerance)

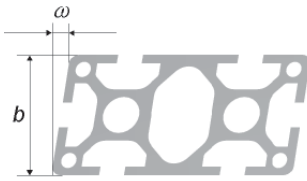

The parallelism tolerance ω (angular tolerance) refers to unequal sides to the shorter side of the angle, i.e. it is measured from the longer side.

Parallelism tolerance		
Width <i>b</i> in mm from	to	max. size tolerance ω in mm
-	30	0.3
30	50	0.4
50	80	0.5
80	100	0.6
100	120	0.7
120	140	0.8
140	160	0.9
160	180	1.0
180	200	1.2
200	240	1.5

Bending strength

For the computation of deflection use formulas on this page.

For the computation of deflection by the profiles own weight, apply "Type of load" 3, 6 or 9.

- f = Deflection in mm
- F = Type of load in N
- l = Profile length in mm
- J 1) = Moment of inertia in mm⁴
- E = Module of elasticity in N/mm²
- E_{AL} = 70,000 N/mm²

1) Comments

- Catalogue data in cm⁴
(Note factor of conversion 10⁴ !)
- The moments of inertia of a certain profile are listed on the respective profile page (p. 1.09, 1.10, 1.11) and in the tables 1.1D

Type of load		
1		$f = \frac{F \cdot l^3}{3E \cdot J}$
2		$f = \frac{F \cdot l^3 + F_1 \cdot l_1^2 \cdot l + F_2 \cdot l_2^2 \cdot l}{3E \cdot J}$
3		$f = \frac{F \cdot l^3}{8E \cdot J}$
4		$f = \frac{F \cdot l^3}{48E \cdot J}$
5		$f = \frac{F \cdot l^3}{\left(48 + \frac{29m}{l}\right) \cdot E \cdot J}$
6		$f = \frac{5F \cdot l^3}{384E \cdot J}$
7		$f = \frac{F \cdot a^2 \cdot b^2}{3E \cdot J \cdot l}$
8		$f = \frac{F \cdot l^3}{192E \cdot J} \quad 2)$
9		$f = \frac{F \cdot l^3}{384E \cdot J}$

2) approximate value

Approximate determination of deflection

To determine the approximation of deflection, use the diagram on this page.

Profile length l in mm

Determination of deflection

1. Type of load F in N
2. Profile length l in mm
3. Move cross point on the diagonal
4. Moment of inertia of the selected profile J in cm^4
5. Cross point with the diagonal to be vertically extended to the bottom
6. Deflection f for the specific "Type of load" in mm

Example

- ① $F = 2,000 \text{ N}$
- ② $l = 1,000 \text{ mm}$
- ③ Move cross point on the diagonal
- ④ $J = 82.0 \text{ cm}^4$ for profile $40 \times 80, 6E$
- ⑤ Cross point with the diagonal to be vertically extended to the bottom
- ⑥ Deflection for the specific "Type of load" in mm:

Type of load 1: $f = 9.5 \text{ mm}$
 Type of load 4: $f = 0.6 \text{ mm}$
 Type of load 8: $f = 0.15 \text{ mm}$

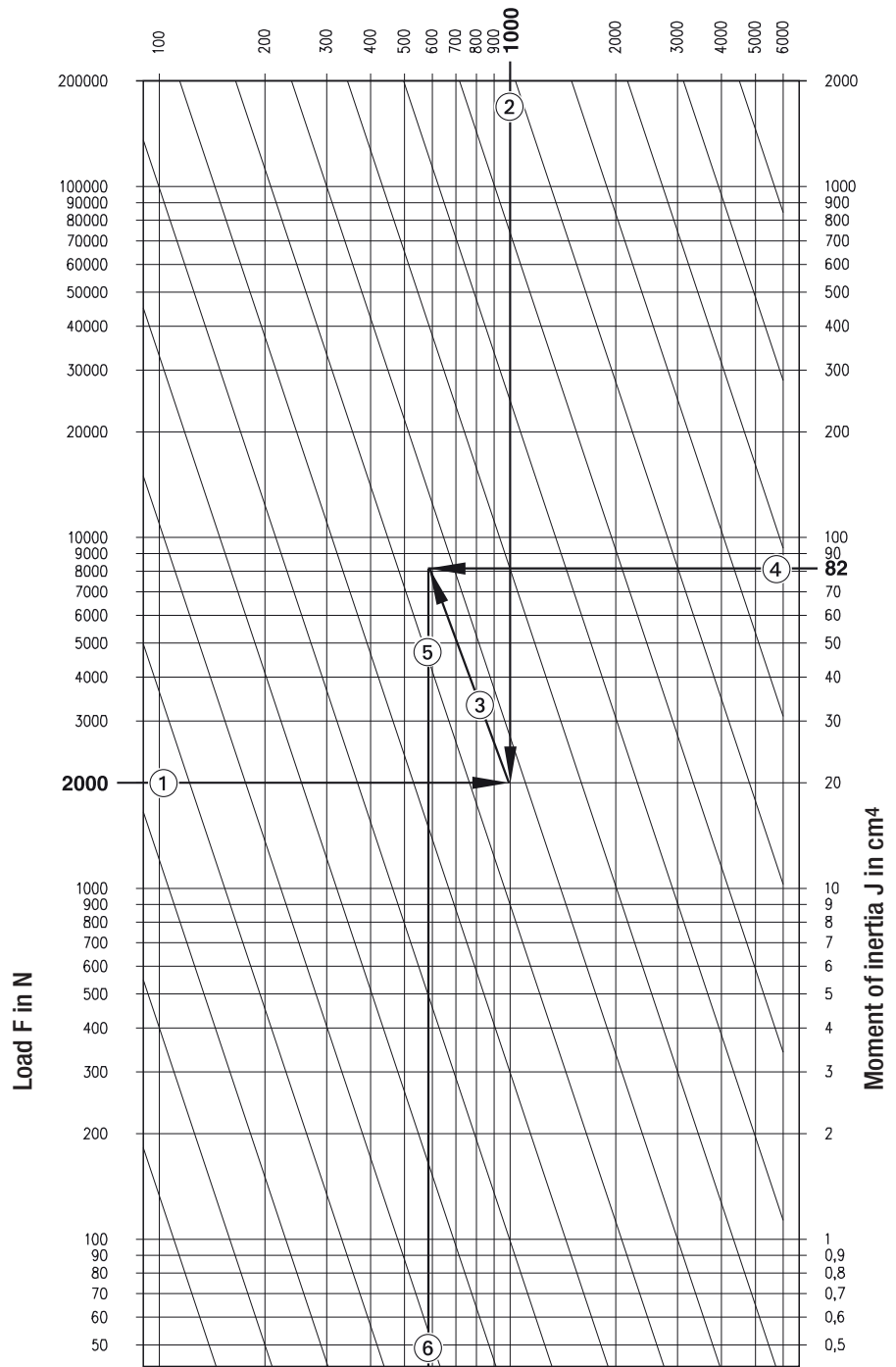

Type of load 1

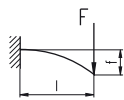



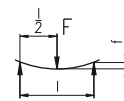



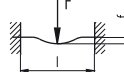















Type of load 4



















Type of load 8



Deflection f in mm

Design	PG slot																							
16 F	E	16x40	16x80	16x160																				
20 H	F				20x10																			
30 F	E4					30x30	30x30	30x30	30x30	30x30	30x30	30x30	30x30	30x30	30x30	30x30	30x30	30x30	30x30	30x30	30x30	30x30	30x30	30x30
40 E3						40x40	40x40	40x40	40x40	40x40	40x40	40x40	40x40	40x40	40x40	40x40	40x40	40x40	40x40	40x40	40x40	40x40	40x40	40x40
45 E4						45x45	45x45	45x45	45x45	45x45	45x45	45x45	45x45	45x45	45x45	45x45	45x45	45x45	45x45	45x45	45x45	45x45	45x45	45x45
50 E4						50x50	50x50	50x50	50x50	50x50	50x50	50x50	50x50	50x50	50x50	50x50	50x50	50x50	50x50	50x50	50x50	50x50	50x50	50x50
60 E4																								





















	Profile	$I_x^{1)}$	$I_y^{1)}$	$W_x^{2)}$	$W_y^{2)}$	$G^{3)}$	β	
	16x40, 1F, LP	4.4	0.8	2.2	0.8	0.87	12	
	16x40, 1E, LP	4.3	0.8	2.2	0.8	0.75	12	
	16x40, 1E, SP	7.2	1.1	3.6	1.1	1.14	12	
	16x80, 2E, LP	30.7	1.6	7.7	1.6	1.49	12	
	16x80, 2E, SP	48.3	2.2	12.0	2.2	2.11	12	
	16x160, 4E, LP	221.0	3.2	27.5	3.2	2.6	12	
	20x10, 1F, LP	0.1	0.6	0.2	0.5	0.35	15	
	20x20, 2H, soft, SP	0.6	0.6	0.6	0.6	0.52	13	
	30x30, 2F, soft, SP	2.7	2.7	1.6	1.6	0.9	16	
	20x20, 2F, soft, S	2.7	2.7	1.6	1.6	0.9	34	
	40x40, 2E, soft, LP	6.4	6.4	3.8	3.8	1.2	20	
	40x40, 2E, soft, L	6.4	6.4	3.8	3.8	1.2	36	
	45x45, 2E, soft, LP	11.4	11.4	5.1	5.1	1.6	28	
	50x50, 2E, soft, S	18.8	18.8	7.5	7.5	2.3	40	
	30x30, 0F, SP	4.4	4.4	2.3	2.3	1.3	16	
	40x40, 0E, SP	12.6	12.6	6.3	6.3	2.0	20	
	45x45, 0E, LP	15.5	15.5	6.9	6.9	2.2	28	
	30x30, 1F, LP	3.1	3.1	2.1	2.1	0.9	16	
	30x30, 1F, SP	4.3	4.0	2.9	2.6	1.2	16	
	40x40, 1E, LP	10.1	9.8	5.0	4.8	1.5	20	
	45x45, 1E, LP	14.7	15.5	6.5	6.8	2.1	28	
	30x30, 2F, cor., S	3.7	3.7	2.4	2.4	1.1	34	
	20x20, 2H, cor., SP	1.0	1.0	0.9	0.9	0.68	13	
	30x30, 2F, cor., LP	3.2	3.2	2.1	2.1	0.9	16	
	30x30, 2F, cor., SBP	3.7	3.7	2.4	2.4	1.1	16	
	30x30, 2F, cor., L	3.2	3.2	2.1	2.1	0.9	34	
	30x30, 2F, cor., SB	3.7	3.7	2.4	2.4	1.1	34	
	40x40, 2E, cor., LP	9.9	9.9	4.9	4.9	1.5	20	
	40x40, 2E, cor., SP	12.0	12.0	6.0	6.0	2.0	20	
	40x40, 2E, cor., L	8.0	8.0	4.0	4.0	1.3	36	
	40x40, 2E, cor., S	12.3	12.3	6.1	6.1	2.0	36	
	45x45, 2E, cor., LP	14.7	14.7	6.6	6.6	2.0	28	
	50x50, 2E, cor., L	16.5	16.5	6.7	6.7	1.7	40	
	50x50, 2E, cor., S	27.4	27.4	10.9	10.9	3.0	40	
		20x20, 2H, LP	1.0	0.8	1.0	0.8	0.58	13
		30x30, 2F, LP	3.2	3.2	2.1	2.1	0.9	17
30x30, 2F, SP		3.6	3.9	2.4	2.6	1.1	17	
30x30, 2F, L		3.2	3.2	2.2	2.2	0.9	34	
40x40, 2E, LP		8.2	7.5	4.1	3.8	1.3	21	
40x40, 2E, L		8.2	7.5	4.1	3.8	1.3	36	
45x45, 2E, LP		14.0	15.5	6.2	6.9	2.0	29	
50x50, 2E, L		17.7	13.6	7.0	5.4	1.6	40	











	Profile	$I_x^{1)}$	$I_y^{1)}$	$W_x^{2)}$	$W_y^{2)}$	$G^{3)}$	β
	60x60, 2E, LP	35.1	37.7	11.7	12.5	2.9	32
	60x60, 2E, SP	55.9	58.5	18.6	19.5	4.3	32
	20x20, 3H, SP	0.9	0.9	0.9	0.9	0.65	13
	30x30, 3F, LP	3.0	3.0	2.0	2.0	0.9	17
	30x30, 3F, SP	3.5	3.7	2.4	2.4	1.1	17
	30x30, 3F, L	3.3	3.2	2.2	2.2	0.9	34
	30x30, 3F, S	3.5	3.7	2.4	2.4	1.1	34
	40x40, 3E, LP	9.5	9.9	4.7	4.9	1.5	21
	40x40, 3E, L	8.3	8.8	4.1	4.4	1.4	36
	40x40, 3E, S	12.0	12.3	6.0	6.0	2.0	36
	45x45, 3E, LP	14.0	14.7	6.2	6.5	2.1	29
	50x50, 3E, L	18.4	16.0	7.3	5.8	1.9	40
	50x50, 3E, S	27.3	28.2	11.1	11.1	3.1	40
		20x20, 4H, LP	0.8	0.8	0.8	0.8	0.53
20x20, 4H, SP		0.9	0.9	0.9	0.9	0.62	14
30x30, 4F, LP		3.3	3.3	2.2	2.2	0.9	17
30x30, 4F, SP		3.5	3.5	2.4	2.4	1.1	17
30x30, 4F, L		3.3	3.3	2.2	2.2	0.9	35
30x30, 4F, S		3.5	3.5	2.4	2.4	1.1	35
40x40, 4E, LP		9.6	9.6	4.7	4.7	1.5	21
40x40, 4E, SP		12.0	12.0	6.0	6.0	2.0	21
40x40, 4E, L		9.9	9.9	4.9	4.9	1.5	37
40x40, 4E, S		12.0	12.0	6.0	6.0	2.0	37
45x45, 4E, LP		13.5	13.5	6.0	6.0	1.9	29
45x45, 4E, SP		15.5	15.5	6.9	6.9	2.1	29
45x45, 4E, L		13.5	13.5	6.0	6.0	1.9	39
45x45, 4E, S		16.8	16.8	7.4	7.4	2.3	39
50x50, 4E, L		19.2	19.2	7.7	7.7	2.2	41
50x50, 4E, S		27.3	27.3	11.0	11.0	3.1	41
60x60, 4E, LP		35.5	35.5	11.7	11.7	2.7	32
60x60, 4E, SP		56.0	56.0	18.7	18.7	4.2	32
60x60, 4E, L		35.5	35.5	11.7	11.7	2.7	42
60x60, 4E, S		56.0	56.0	18.7	18.7	4.2	42
	45x60, 4E, LP	26.5	16.0	9.0	7.2	2.3	29
	45x60, 4E, L	26.5	16.0	9.0	7.2	2.3	40
	20x30, 1F, LP	2.2	1.4	1.5	1.4	0.7	15
	20x30, 2F, LP	2.2	1.5	1.5	1.5	0.74	15
	20x30, 2F, SP	2.6	1.9	1.7	1.7	1.0	15
	60x90, 6E, L	125.8	54.3	27.9	18.1	3.9	42
	60x90, 6E, S	193.0	83.0	43.0	27.5	6.0	42
	30x50, 4F, L	11.0	4.3	4.8	3.3	1.3	35
	30x50, 4F, S	16.9	6.6	6.7	4.4	2.0	35







¹⁾ I_x, I_y = moment of inertia in cm^4

²⁾ W_x, W_y = moment of resistance in cm^3

















³⁾ G = weight in kg/m















Design																					
PG slot																					
16 F																					
E																					
20 H			20x40				20x40														
F																					
30 F	30x60						30x60			30x100	30x100			30x150							
E4									30x100								30x150				
40 E3	40x80	40x80		40x80	40x80	40x80	40x80						40x160	40x160							
45 E4	45x90						45x90														
50 E4							50x100	50x100	50x150												
60 E4																					

	Profile	$I_x^{1)}$	$I_y^{1)}$	$W_x^{2)}$	$W_y^{2)}$	$G^{3)}$	β_{\rightarrow}
	30x60, 0F, SP	29.0	7.8	9.6	5.2	2.2	17
	40x80, 0E, LP	66.8	18.4	16.7	9.2	2.7	21
	45x90, 0E, LP	107.5	30.4	23.9	13.5	3.6	29
	40x80, 0E, SP	134.3	36.3	29.8	16.2	4.7	29
	40x80, 3E, cor., LP	66.9	18.1	16.7	9.0	2.6	21
	20x40, 4H, SP	7.0	2.0	3.5	2.0	1.3	14
	40x80, 4E, LP	65.8	18.1	16.5	9.0	2.6	22
	40x80, 4E, L	63.2	17.8	15.7	8.9	2.6	37
	40x80, 4E, LBP	74.5	18.3	18.6	9.2	2.8	22
	40x80, 5E, LP	72.2	18.1	18.0	9.0	2.8	22
	20x40, 6H, LP	5.3	1.4	2.6	1.4	0.9	14
	20x40, 6H, SP	6.4	1.7	3.2	1.7	1.3	14
	30x60, 6F, LP	22.1	5.9	7.4	3.9	1.6	17
	30x60, 6F, SP	25.0	7.0	8.3	4.7	2.1	17
	30x60, 6F, L	21.9	5.8	7.4	3.8	1.6	35
	30x60, 6F, S	25.0	7.0	8.3	4.7	2.1	35
	40x80, 6E, LP	65.4	17.5	16.4	8.8	2.5	22
	40x80, 6E, SP	82.0	23.4	20.5	11.7	3.8	22
	40x80, 6E, L	62.7	17.0	15.6	8.5	2.6	37
	40x80, 6E, S	82.0	23.4	20.5	11.7	3.8	37
	45x90, 6E, LP	98.0	27.5	21.8	12.2	3.3	30
	45x90, 6E, SP	126.0	34.0	28.0	15.0	4.4	30
	45x90, 6E, L	98.0	27.5	21.8	12.2	3.3	39
	45x90, 6E, S	126.0	34.0	28.0	15.0	4.4	39
	50x100, 6E, L	138.0	37.0	27.5	14.5	3.5	41
50x100, 6E, S	202.0	57.2	40.4	22.8	5.9	41	
	50x100, 8E, L	137.0	40.0	27.5	16.0	4.0	41
	50x100, 8E, S	200.0	53.3	39.9	21.3	6.0	41
	40x120, 8E, L	198.5	25.2	34.2	12.6	3.6	37
	50x150, 8E, S	628.0	83.0	83.0	33.0	8.1	41
	30x100, 5E, 2F, SP	108.9	12.4	21.7	8.3	3.5	18

	Profile	$I_x^{1)}$	$I_y^{1)}$	$W_x^{2)}$	$W_y^{2)}$	$G^{3)}$	β_{\rightarrow}
	30x100, 8F, SP	115.0	11.6	22.9	7.7	3.4	18
	30x100, 10F, SP	127.0	11.9	25.4	7.9	3.6	18
	40x160, 6E, LP	450.4	36.3	56.3	18.1	5.0	23
	40x160, 10E, LP	433.5	33.1	54.2	16.5	4.7	23
	30x150, 8F, SP	340.0	16.0	45.0	11.0	4.1	19
	30x150, 8E, SP	481.0	25.1	64.1	16.7	7.9	19

¹⁾ I_x, I_y = moment of inertia in cm^4
²⁾ W_x, W_y = moment of resistance in cm^3
³⁾ G = weight in kg/m

Design	PG slot																
16	F																
16	E																
20	H																
20	F																
30	F					60x60		60x60									
30	E4																
40	E3	80x80	80x80	80x80	80x80	80x80	80x80	80x80	80x80	80x120	80x160	80x160	80x160	120x120			
45	E4					90x90	90x90										
50	E4					100x100	100x100					100x200					
60	E4																

	Profile	$I_x^{1)}$	$I_y^{1)}$	$W_x^{2)}$	$W_y^{2)}$	$G^{3)}$	β	γ
	80x80, 0E, LP	135.0	135.0	33.5	33.5	4.7	24	
	80x80, 4E, cor., LP	128.0	128.0	32.0	32.0	4.5	24	
	80x80, 6E, LP	121.3	116.0	30.3	29.0	4.2	24	
	80x80, 7E, SP	173.0	160.0	43.3	40.0	7.6	24	
	60x60, 8F, L	38.7	38.7	12.9	12.9	2.6	35	
	80x80, 8E, LP	114.0	114.0	28.4	28.4	4.1	24	
	8E, SP	166.0	166.0	41.4	41.4	5.9	24	
	8E, L	111.0	111.0	28.0	28.0	4.1	38	
	8E, S	166.0	166.0	41.4	41.4	5.9	38	
	90x90, 8E, LP	190.5	190.5	42.3	42.3	5.6	30	
	8E, L	183.0	183.0	40.7	40.7	5.3	39	
	100x100, 8E, S	411.0	411.0	82.0	82.0	9.7	41	
	80x80, 8E, LB	115.0	115.0	29.0	29.0	4.5	38	
	90x90, 8E, SP	282.0	282.0	63.0	63.0	9.5	30	
	8E, S	282.0	282.0	63.0	63.0	9.5	39	
	100x100, 8E, L	254.1	254.1	45.4	45.4	6.2	41	
	60x60, 8F, angle, S	35.2	35.2	9.9	9.9	2.8	35	
	80x80, 8E, angle, S	120.0	120.0	23.8	23.8	6.3	38	
	80x120, 10E, SP	449.9	217.8	72.6	54.4	8.6	25	
	80x160, 8E, SP	944.0	183.0	118.0	45.8	7.9	25	
	80x160, 8E, LP	828.0	259.0	104.0	65.0	8.6	25	
	80x160, 12E, SP	883.0	269.0	110.0	67.3	9.4	25	
	12E, L	801.0	235.0	100.0	59.0	8.8	38	
	12E, S	880.0	268.0	110.0	67.0	9.4	38	
	100x200, 12E, SP	2,450.0	760.0	250.0	152.0	17.2	31	

	Profile	$I_x^{1)}$	$I_y^{1)}$	$W_x^{2)}$	$W_y^{2)}$	$G^{3)}$	β	γ
	120x120, 12E, SP	624.0	624.0	104.0	104.0	10.6	25	

¹⁾ I_x, I_y = moment of inertia in cm^4
²⁾ W_x, W_y = moment of resistance in cm^3
³⁾ G = weight in kg/m

Design	PG slot															
16	F															
	E															
20	H															
	F															
30	F										30 octag.					
	E4															
40	E3	40x40	80x80	40x30°	40x45°	40x60°	40x90°				40 octag.					
45	E4															
50	E4							48 round	48 round	48 round						
60	E4															

Profile	$I_x^{1)}$	$I_y^{1)}$	$W_x^{2)}$	$W_y^{2)}$	$G^{3)}$	↗
40x40, 2E, 45°, LP	7.3	7.3	3.9	3.9	1.4	27
80x80, 7E, 45°, LP	99.3	99.3	24.8	24.8	4.0	27
40, round 30°, 2F, LP	6.0	4.8	3.0	2.4	1.2	26
40, round 45°, 2E, LP	14.5	8.0	4.9	3.7	1.6	26
40, round 60°, 2E, LP	30.0	10.5	7.6	4.6	1.9	26

Profile	$I_x^{1)}$	$I_y^{1)}$	$W_x^{2)}$	$W_y^{2)}$	$G^{3)}$	↗
40, round 90°, 2E, LP	89.0	89.0	16.0	16.0	3.0	26
48, round, 1E, SP	12.5	12.9	4.9	5.4	1.8	43
48, round, 2E, cor., SP	12.0	12.0	5.0	5.0	2.0	43
48, round, 2E, SP	12.5	13.5	5.1	5.9	2.0	43
30 octag., 8F, SP	84.0	84.0	21.0	21.0	3.9	43
40 octag., 8E, SP	233.0	233.0	44.0	44.0	6.5	43

Design	PG slot															
16	F															
	E															
20	H															
	F															
30	F	30x30	30x30	30x30	30x30	30x45	30x50	30x50								
	E4															
40	E3		40x40	40x40	40x40	40x60	40x60	40x60	60x80	60x80						
45	E4															
50	E4			50x50	50x50											
60	E4															

Profile	$I_x^{1)}$	$I_y^{1)}$	$W_x^{2)}$	$W_y^{2)}$	$G^{3)}$	↗
30x30, 0F, P, LP	3.8	3.8	2.4	2.4	1.10	44
30x30, 2F, P, LP 5	4.3	3.3	2.8	2.2	1.20	44
30x30, 2F, P, LP 6	3.6	2.8	2.4	1.9	1.00	44
30x30, 2F, WG, LP 7.5	2.6	3.2	1.7	2.1	0.86	47
40x40, 2E, WG, LP 7.5	7.5	8.2	3.8	4.1	1.35	47
30x30, 2F, c., P, LP 4	3.3	3.3	2.2	2.2	1.00	44
40x40, 2E, c., P, LP 4	10.3	10.3	5.2	5.2	1.80	45
50x50, 2E, c., P, LP 4	19.4	19.4	7.6	7.6	2.40	46
30x30, 3F, P, LP 4	3.3	2.8	2.2	1.8	0.90	44
40x40, 3E, P, LP 4	10.2	8.7	5.1	4.3	1.65	45
50x50, 3E, P, LP 4	24.1	21.4	8.0	8.5	2.70	46

Profile	$I_x^{1)}$	$I_y^{1)}$	$W_x^{2)}$	$W_y^{2)}$	$G^{3)}$	↗
30x45, 2F, WG, LP 7.5	4.3	7.4	2.9	3.3	1.15	47
40x60, 2E, 1F, WG, LP 7.5	12.2	22.5	6.1	7.5	1.97	47
30x50, 2F, P, LP 5	7.0	14.7	4.7	5.9	1.90	44
30x50, 3F, P, LP 4	5.5	11.8	3.6	4.8	1.5	44
40x60, 3E, P, LP 4	14.8	26.3	7.4	8.8	2.4	45
60x80, 5E, P, LP 4	100.4	50.4	25.1	16.8	3.8	45
60x80, 6E, P, LP 4	88.1	52.0	22.1	17.3	3.7	45

¹⁾ I_x, I_y = moment of inertia in cm^4
²⁾ W_x, W_y = moment of resistance in cm^3
³⁾ G = weight in kg/m

Profile combinations

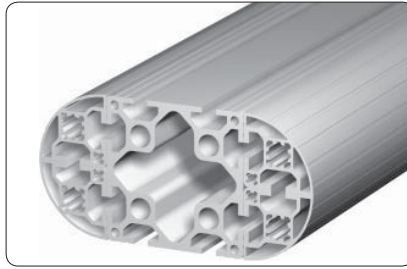

With the MayTec Connector System it is possible to make a multitude of form-matching and stable profile combinations.

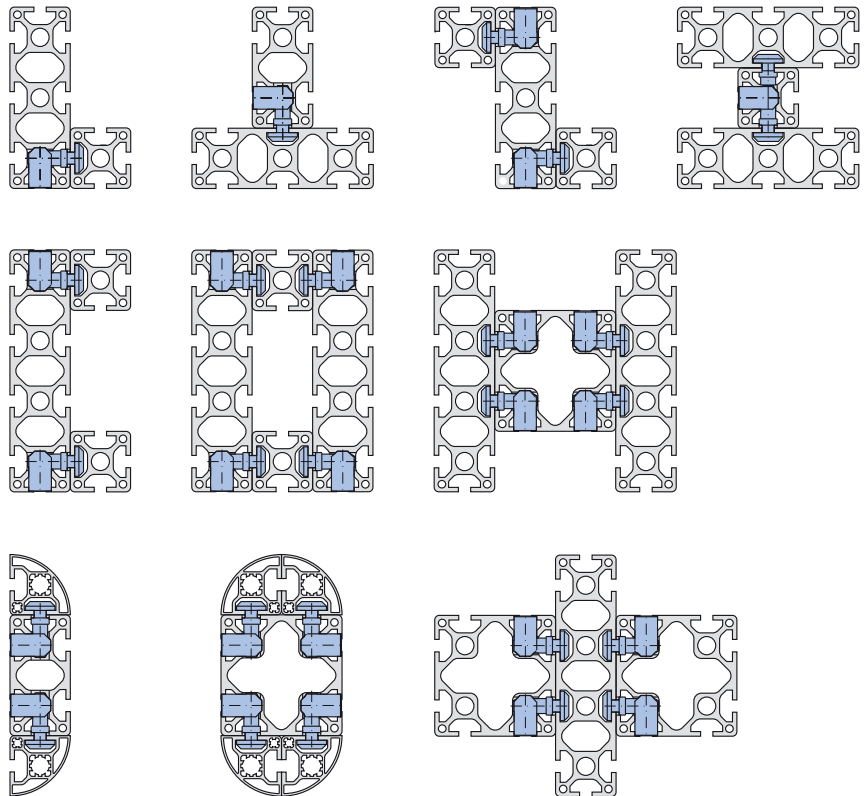

Special slits

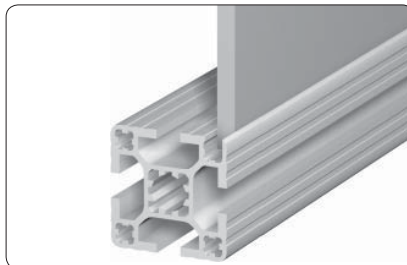

Panel elements can be set in the profile flush to the outer edge for form-matching design. The slits needed for that can be made in nearly all profiles.

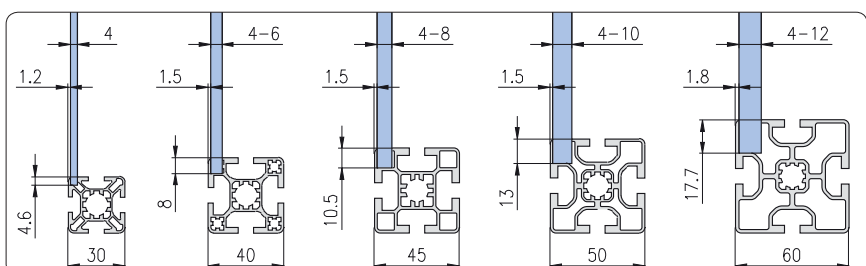

Slot plates

F-slot

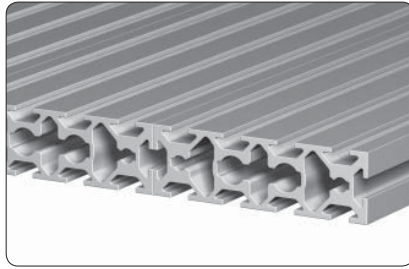

F-slot, slot distance 25 mm

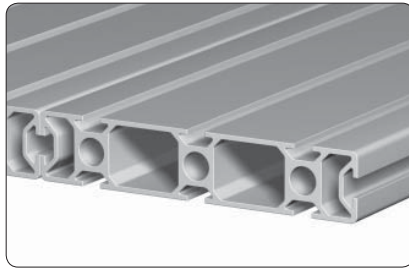

F-slot, slot distance 50 mm

Application

Profiles to construct slot plates of any required size

E-slot

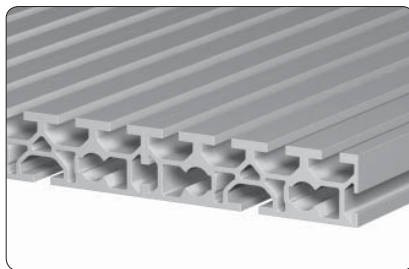

E-slot, slot distance 25 mm (on top),
100 mm (on bottom)

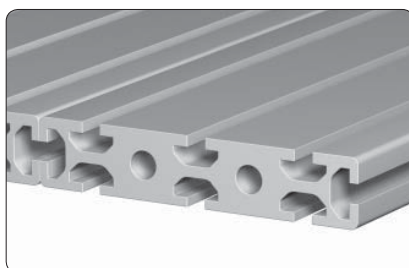

E-slot, slot distance 50 mm

Slot plates F-slot
Slot distance 25 mm

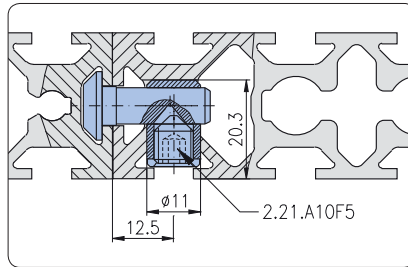
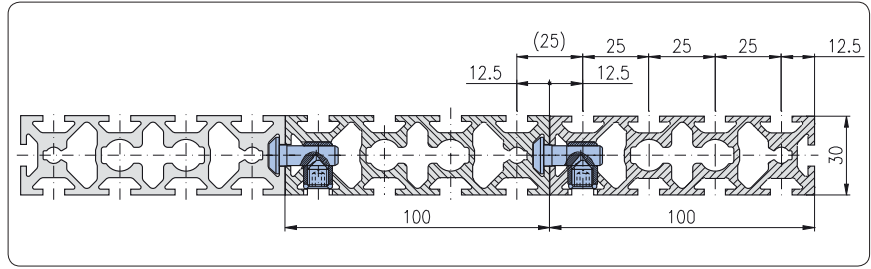

Drill dimensions

Single parts

- anchor 2.21.A10F5
- cross bushing 2.21.B10

Profile 30×100, 10F, SP

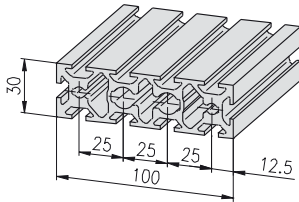

Description

Profile 30×100, 10F, SP

Weight

bar 6 m

3.6 kg/m 1.11.030100.104SP.60

Article-No.

Slot plates F-slot
Slot distance 50 mm

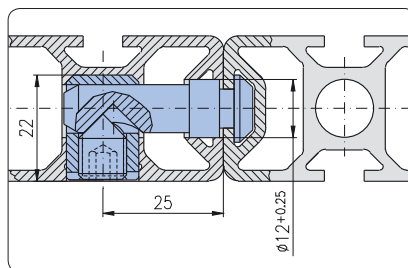
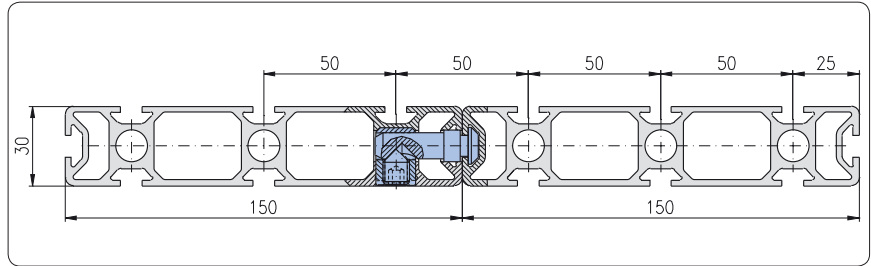

Drill dimensions

Single parts

- anchor 1.21.A5F5
- cross bushing 1.21.B30

Profile 30×150, 8F, SP

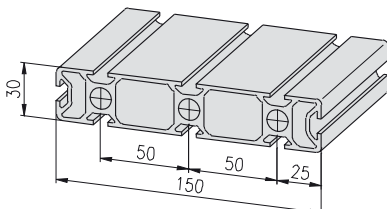

Description

Profile 30×150, 8F, SP

Weight

bar 6 m

4.1 kg/m 1.11.030150.85SP.60

Article-No.

machining data → Profile machining 1.1A

Slot plates E-slot
Slot distance 25 mm

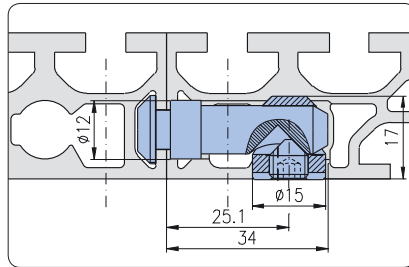
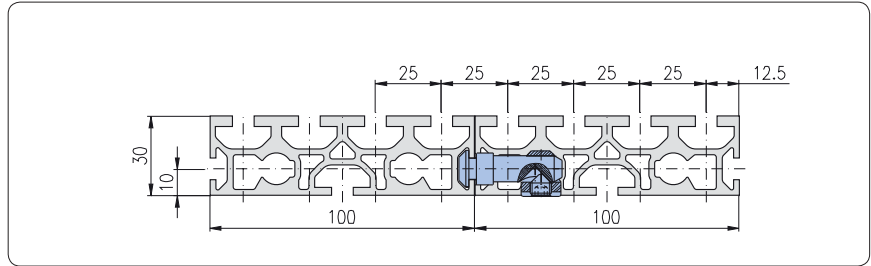

Drill dimensions

Single parts

- anchor 1.21.A5F5
- cross bushing 1.21.B24

Profile 30×100, 5E, 2F, SP

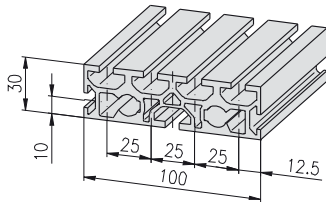

Description

Profile 30×100, 5E, 2F, SP

Weight

bar 6 m

3.5 kg/m

Article-No.

1.11.030100.74SP.60

Slot plates E-slot
Slot distance 50 mm

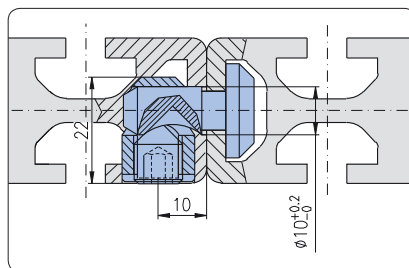
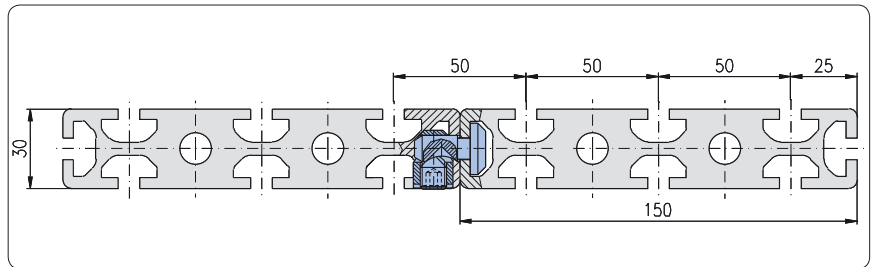

Drill dimensions

Single parts

- anchor 1.21.A2E5
- cross bushing 1.21.B34

Profile 30×150, 8E, SP

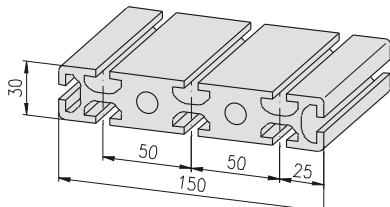

Description

Profile 30×150, 8E, SP

Weight

bar 6 m

7.9 kg/m

Article-No.

1.11.030150.84SP.60

Hand rail



Post: Profile 40x40

Application

Hand rail for balustrades on stairs and platforms

Comments

Angled joints: 0 deg. to 90 deg.
Incline: 0 deg. to 45 deg.

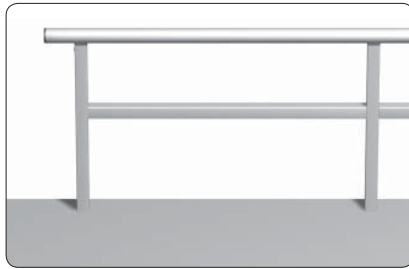

Hand rail straight

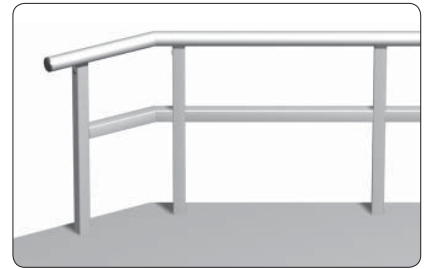

Hand rail angled

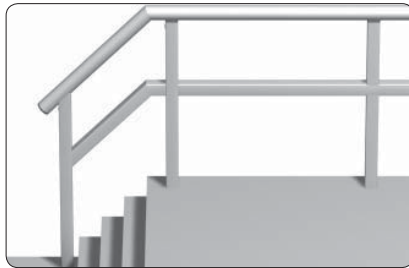

Hand rail tilted

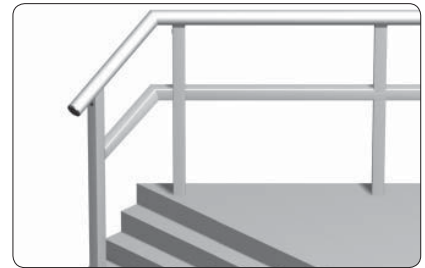

Hand rail tilted and angled

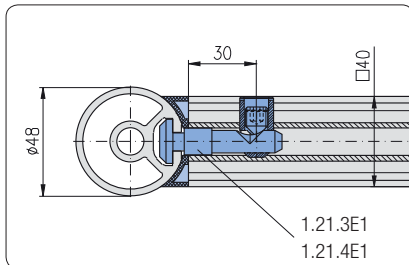

Working dimensions for hand rail straight with radius compensation

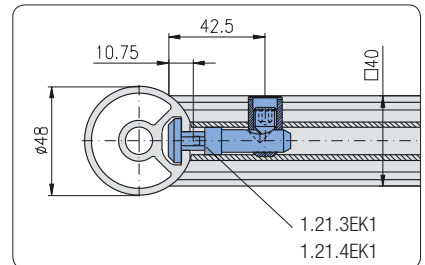

Working dimensions for hand rail straight, tilted and/or angled without radius compensation (milled)

Hand rail

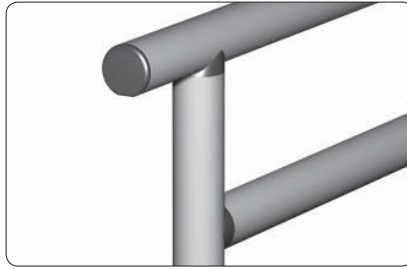

Post: Profile Ø48

Application

Hand rail for balustrades on stairs and platforms

Comments

Angled joints: 0 deg. to 90 deg.
Incline: 0 deg. to 45 deg.

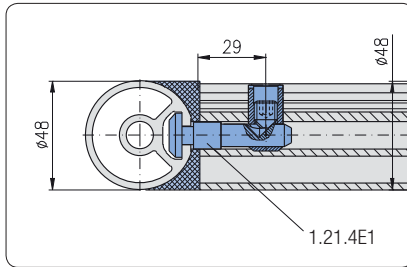

Working dimensions for hand rail straight with radius compensation

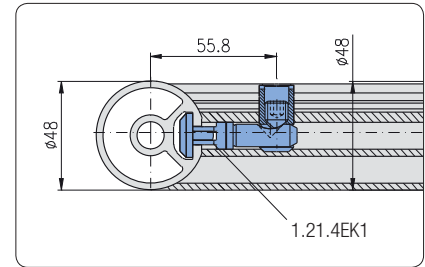

Working dimensions for hand rail straight, tilted and/or angled without radius compensation (milled)



U-Profile 40



Application

For the construction of height adjustable frames on 40×40 and 40×80 profile bases

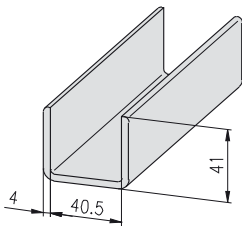
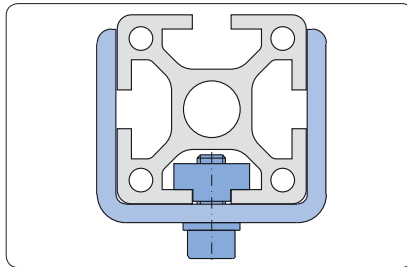

Description

U-Profile 40

Weight

bar 6 m 1.35 kg/m

Article-No.

1.19.14440.60

Profiles for cable guide

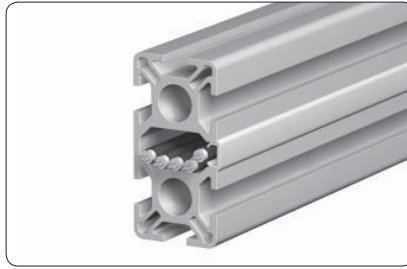

Application

For running cables or pneumatic hoses.
All chamber profiles can be delivered with open slots.

Cover is carried out by cover profiles:

Cover profile PVC 1.41.11□

Cover profile ALU 1.41.121

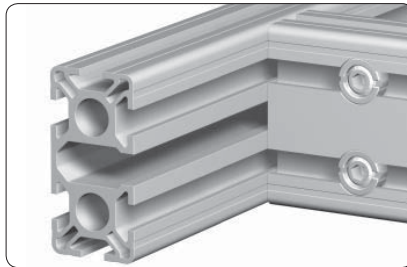

Application of cross braces to stabilize slotted profiles

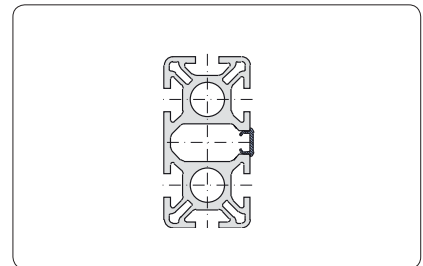
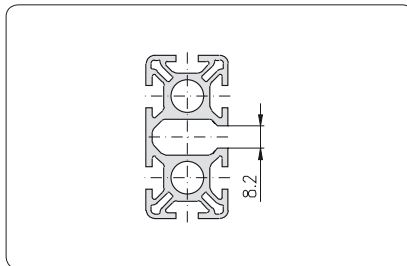

- 16
- 20
- 30
- 40
- 45
- 50
- 60

Comments

Profiles for cable guide see list at profile pre-cut lid

Order details

Description

Article-No.

Profile □□□□□□ for cable guide, slotted 8 mm

1.12.□□□□□□.□□

Order example

Order request

Profile 40×80 mm, 6 E-slots, heavy, 8 mm slotted for cable guide, length 4.5 m

Order

Profile 40×80, 6E S, for cable guide, slotted 8 mm

1.12.040080.65S-F00F00/4500



Profiles for cable guide
Slot distance 30

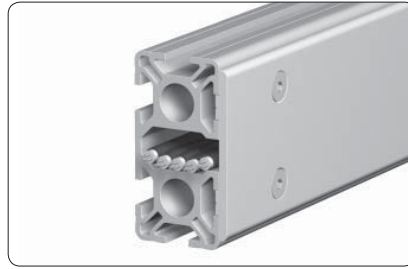

Application

For running cables or pneumatic hoses. All chamber profiles can be delivered with open slots.

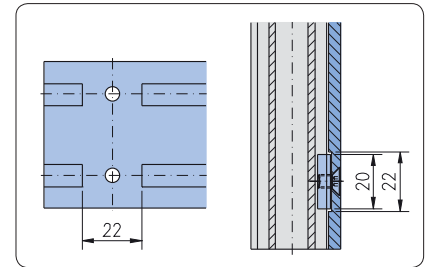
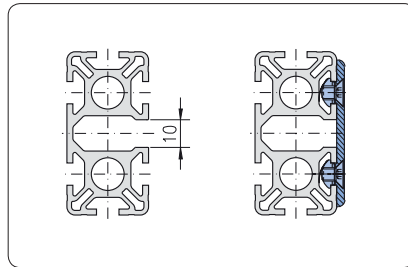

Milled section on the pre-cut lid for fastening with T-Nut in F-slot

Profiles for cable guide, slot distance 30				
Profile	light, plain	heavy, plain	light	heavy
30x60	6F LP	OF SP 6F SP	6F L	6F S
60x60		OF SP	8F L	8F angle S

Order details

Description

Article-No.

Profile □□□□□□ for cable guide, slotted 10 mm

1.13.□□□□□□.□□

Order example

Order request

Profile 30x60 mm, 6 F-slots, heavy, 10 mm slotted for cable guide, length 4.5 m

Order

Profile 30x60, 6F S, for cable guide, slotted 10 mm

1.13.030060.65S-A00A00/4500

Profile pre-cut lid 30

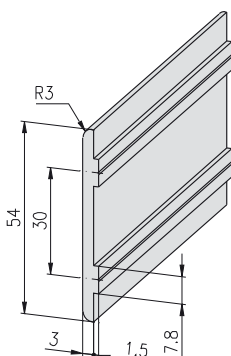

Single parts

- countersunk screw DIN 7991, M5x8 0.63.D07991.05008
- threaded plate F, M5 1.31.FM5
- T-Nut for subsequent insertion F, M5 1.32.4FM5

Description

Weight

Article-No.

Profile pre-cut lid 30

0.49 kg/m

1.19.110130

machining data Profile machining 1.1A

Profiles for cable guide
Slot distance 40

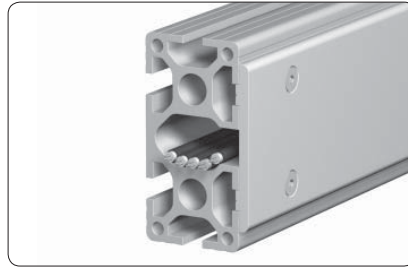

Application

For running cables or pneumatic hoses. All chamber profiles can be delivered with open slots.

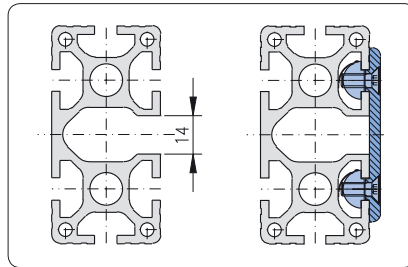

Profiles for cable guide, slot distance 40										
Profile	light, plain					heavy, P	light		heavy	
40x80	0E LP	3E c.LP	4E LP	4E LBP	5E LP	6E LP	6E SP	4E L	6E L	6E S
80x80	0E LP	4E c.LP	6E LP	8E LP		7E SP	8E L	8E LB	8E S	
	3E 45° LP	7E 45° LP				8E SP			8E angle S	
	40x160	80x160	80x120	80x160	120x120	40x120	80x160	80x160		
	6E LP	10E LP	8E LP	10E SP	12E SP	12E SP	8E L	12E L	12E S	

Order details

Description

Article-No.

Profile □□□□□□ for cable guide, slotted 14 mm

1.13.□□□□□□.□□

Order example

Order request

Profile 80x80 mm, 8 E-slots, heavy, 14 mm slotted for cable guide, length 4.5 m

Order

Profile 80x80, 8E S, for cable guide, slotted 14 mm

1.13.080080.83S-L00L00/4500

Profile pre-cut lid 40

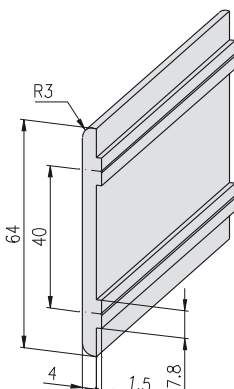

Single parts

- countersunk screw DIN 7991, M6x14 0.63.D07991.06014
- threaded plate E, M6 1.31.EM6
- T-Nut for subsequent insertion E, M6 1.32.4EM6

Description

Weight

Article-No.

Profile pre-cut lid 40

0.74 kg/m

1.19.110140

machining data → Profile machining 1.1A

Profiles for cable guide
Slot distance 50

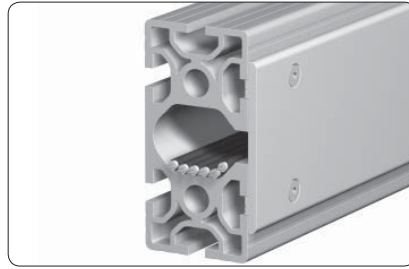

Application

For running cables or pneumatic hoses. All chamber profiles can be delivered with open slots.

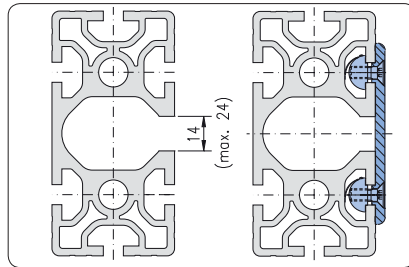

Profiles for cable guide, slot distance 50								
heavy, plain			light		heavy			
30×100	30×150	100×200	50×100	100×100	50×100	50×150	100×100	
8F SP	8F SP	12E SP	6E L	8E L	6E S	8E S	8E S	

Order details

Description

Article-No.

Profile □□□□□□ for cable guide, slotted 14 mm

1.13.□□□□□□.□□

Order example

Order request

Profile 50×100 mm, 6 E-slots, heavy, 14 mm slotted for cable guide, length 4.5 m

Order

Profile 50×100, 6E S, for cable guide, slotted 14 mm

1.13.050100.65S-F00F00/4500

Profile pre-cut lid 50

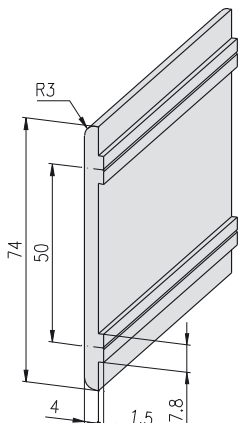

Single parts

F-slot

- countersunk screw DIN 7991, M5×8 0.63.D07991.05008
- threaded plate F, M5 1.31.FM5
- T-Nut for subsequent insertion F, M5 1.32.4FM5

E-slot

- countersunk screw DIN 7991, M6×14 0.63.D07991.06014
- threaded plate E, M6 1.31.EM6
- T-Nut for subsequent insertion E, M6 1.32.4EM6

Description

Weight

Article-No.

Profile pre-cut lid 50

0.85 kg/m

1.19.110150

machining data Profile machining 1.1A

Curved profiles

For curved profiles the following data is required:

- Profile type (current conditions see table below)
- Position of profile ↗ 55
- Radius
- Direction ↗ 57
- Necessary accuracy of dimensions for curved profiles and for all required functionality



Position of profile

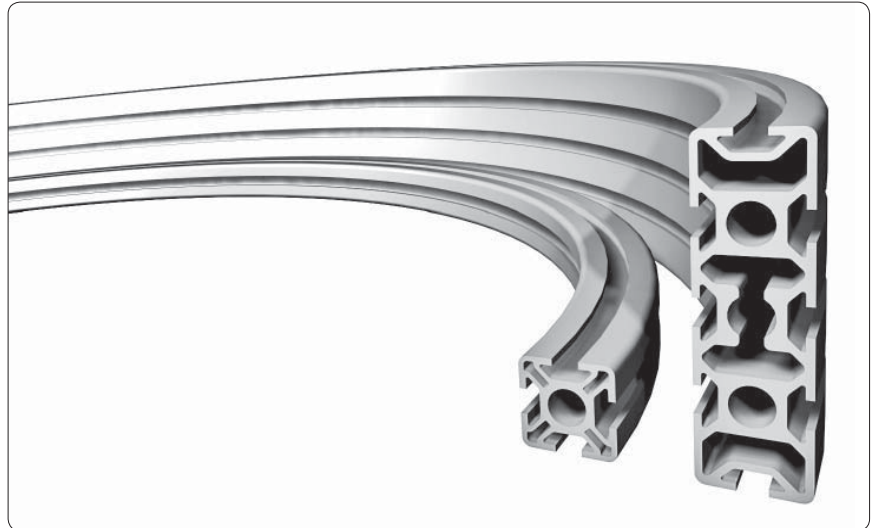

Function 'T- Nut'													Function 'threaded plate'													Function 'connector'																									
position of slot(s)													position of slot(s)													position of slot(s)													position of core hole(s)												
A	B	C	D	E	F	G	H	I	K	L	M	A	B	C	D	E	F	G	H	I	K	L	M	A	B	C	D	E	F	G	H	I	K	L	M	a	b	c	d	e	f	g	h								

The marking of the slots and core holes takes place in accordance with the marking for 'the profile machining' ↗ 1.1A

Article-No.	PG	Profile	min. inside-Ø
1.09.016040.14LP	16	16×40, 1E, LP	400
1.09.016040.14SP		16×40, 1E, SP	400
1.10.016040.14LP		16×40, 1F, LP	400
1.10.020020.21SP	20	20×20, 2H, soft, SP	700
1.10.020020.22SP		20×20, 2H, cor., SP	700
1.10.020020.23LP		20×20, 2H, LP	700
1.10.020020.33SP		20×20, 3H, SP	700
1.10.020020.43LP		20×20, 4H, LP	700
1.10.020020.43SP		20×20, 4H, SP	700
1.11.020010.14LP		20×10, 1F, LP	400
1.11.020030.14LP		20×30, 1F, LP	700
1.11.020030.24LP		20×30, 2F, LP	700
1.11.020030.24SP		20×30, 2F, SP	700
1.11.030030.03SP	30	30×30, 0F, SP	700
1.11.030030.13LP		30×30, 1F, LP	700
1.11.030030.13SP		30×30, 1F, SP	700
1.11.030030.22S		30×30, 2F, cor., S	700
1.11.030030.22SB		30×30, 2F, cor., SB	700
1.11.030030.22SBP		30×30, 2F, cor., SBP	700
1.11.030030.22L		30×30, 2F, cor., L	700
1.11.030030.22LP		30×30, 2F, cor., LP	700
1.11.030030.23L		30×30, 2F, L	700
1.11.030030.23LP		30×30, 2F, LP	700
1.11.030030.23SP		30×30, 2F, SP	700
1.11.030030.33S		30×30, 3F, S	700
1.11.030030.33L		30×30, 3F, L	700
1.11.030030.33LP		30×30, 3F, LP	700
1.11.030030.33SP		30×30, 3F, SP	700
1.11.030030.43S		30×30, 4F, S	700
1.11.030030.43L		30×30, 4F, L	700
1.11.030030.43LP		30×30, 4F, LP	700
1.11.030030.43SP		30×30, 4F, SP	700
1.11.030050.44S		30×50, 4F, S	700
1.11.030050.44L		30×50, 4F, L	700
1.11.030060.04SP		30×60, 0F, SP	700

Article-No.	PG	Profile	min. inside-Ø
1.11.030060.64L		30×60, 6F, L	700
1.11.030060.64LP	30	30×60, 6F, LP	700
1.11.030060.65S		30×60, 6F, S	700
1.11.030060.65SP		30×60, 6F, SP	700
1.11.030100.74SP		30×100, 5E, 2F, SP	700
1.11.030100.84SP		30×100, 8F, SP	700
1.11.030100.104SP		30×100, 10F, SP	700
1.11.040040.03SP	40	40×40, 0E, LP	700
1.11.040040.13LP		40×40, 1E, LP	700
1.11.040040.22S		40×40, 2E, cor., S	700
1.11.040040.22L		40×40, 2E, cor., L	700
1.11.040040.22LP		40×40, 2E, cor., LP	700
1.11.040040.22SP		40×40, 2E, cor., SP	700
1.11.040040.23L		40×40, 2E, L	700
1.11.040040.23LP		40×40, 2E, LP	700
1.11.040040.33S		40×40, 3E, S	700
1.11.040040.33L		40×40, 3E, L	700
1.11.040040.33LP		40×40, 3E, LP	700
1.11.040040.43S		40×40, 4E, S	700
1.11.040040.43L		40×40, 4E, L	700
1.11.040040.43LP		40×40, 4E, LP	700
1.11.040040.43SP		40×40, 4E, SP	700
1.11.040080.04LP		40×80, 0E, LP	700
1.11.040080.44L		40×80, 4E, L	700
1.11.040080.64L		40×80, 6E, L	700
1.11.040080.65S		40×80, 6E, S	700
1.11.040080.32LP		40×80, 3E, cor., LP	700
1.11.040080.44LP		40×80, 4E, LP	700
1.11.040080.44LBP		40×80, 4E, LBP	700
1.11.040080.54LP		40×80, 5E, LP	700
1.11.040080.64LP		40×80, 6E, LP	700
1.11.040080.64SP		40×80, 6E, SP	700
1.11.048R00.10SP		48, round, 1E, SP	1.500
1.11.048R00.20SP		48, round, 2E, SP	1.500
1.11.048R00.22SP		48, round, 2E, cor., SP	1.500

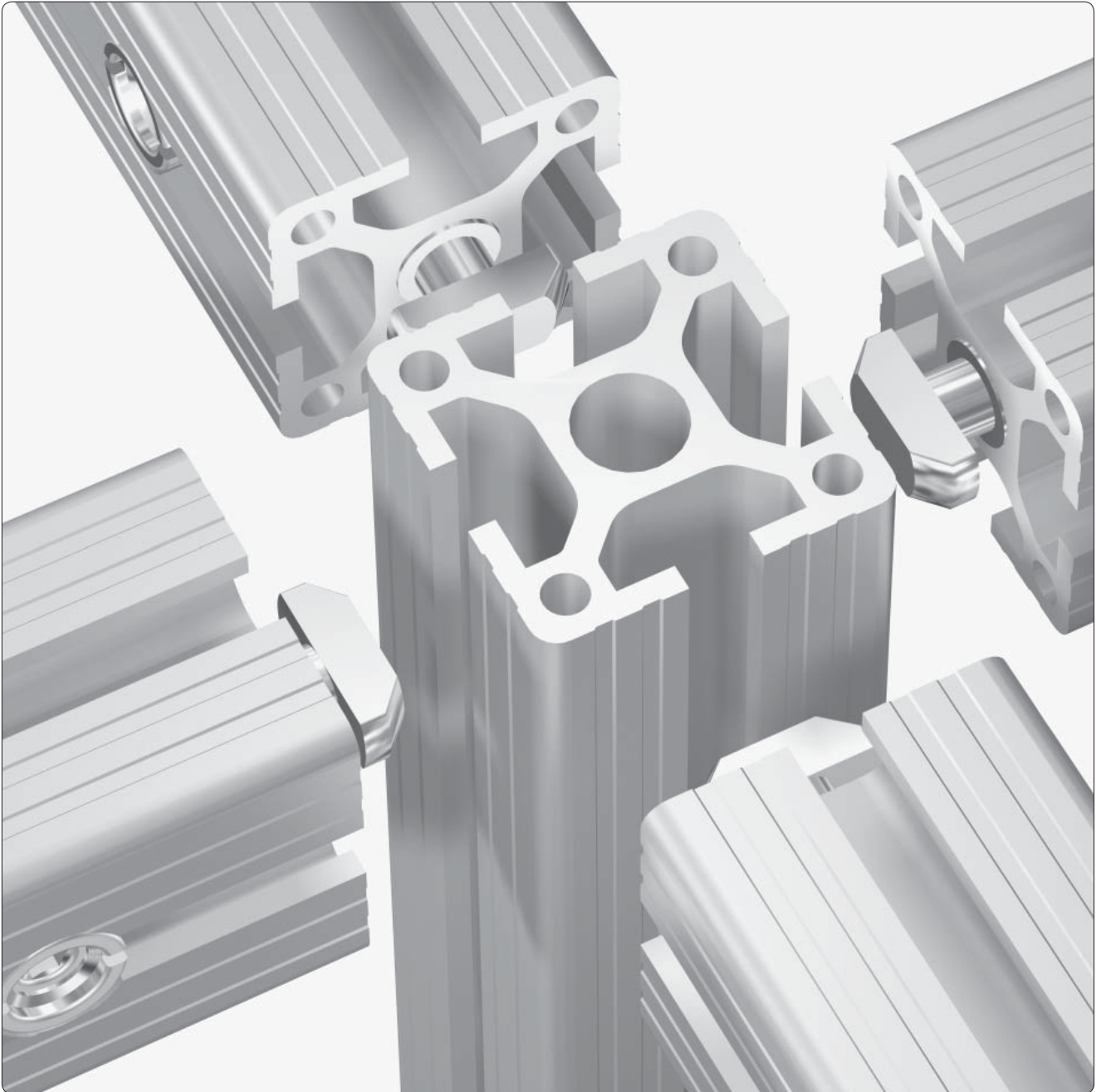

extremely strong

efficient

functional

The proven connection system!

The MayTec quick-connection system allows combination of all MayTec profiles in any way imaginable.

It carries same stability out after all four sides.

The connection allows:

- easy machining
- quick assembly
- innumerable (dis)assemblies

The connection system is:

- complete
- stable
- functional

Vibration proof

The different direction angles of lead of thread and clamping cone prevent the loosening of the connection by vibration.

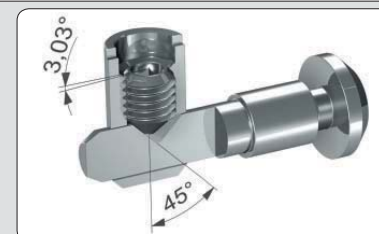



Stability S-Class

**MayTec
Universal-Connector**

18,000N
working load

**Vibration
proof**

MayTec connector with square head

The MayTec connector with square head offers the highest load bearing capacity.

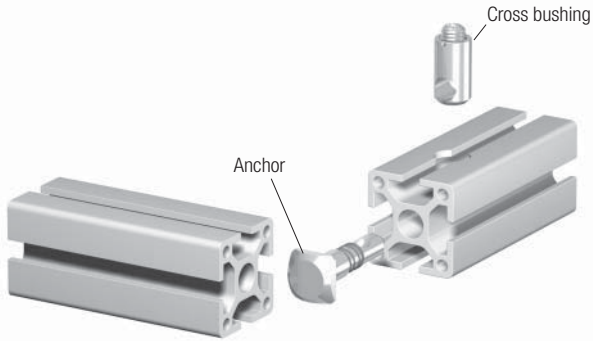

MayTec universal-connector

The MayTec universal-connector allows:

- any desired position of profiles
- only one type for 0° and 90° position of cross bushing
- simple determination of the connector type
- minimisation of stock keeping

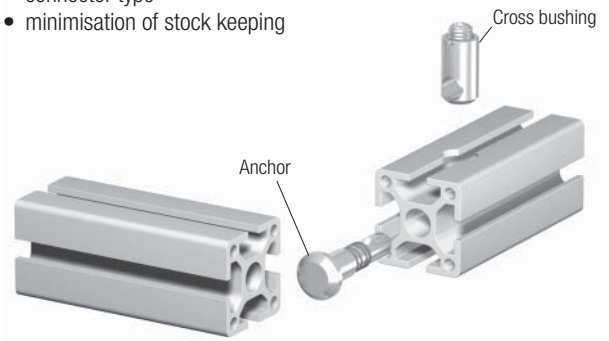

MayTec standard-connector

The MayTec standard-connector allows subsequent front-sided mounting or dismounting in any location.

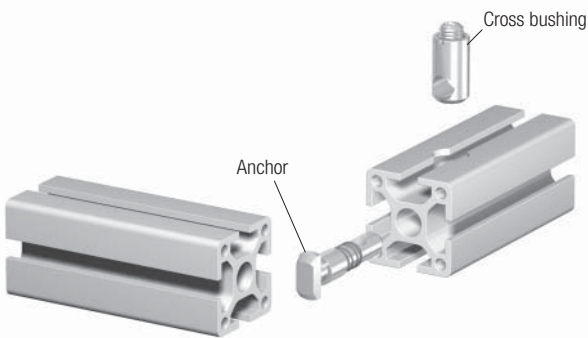

MayTec ground-connector for potential equalisation

The MayTec ground-connector allows potential equalisation between two profiles. When the connector is tightened, the serration at the rear of the anchor head penetrates the anodised profile coating and thus provides an electrical contact.

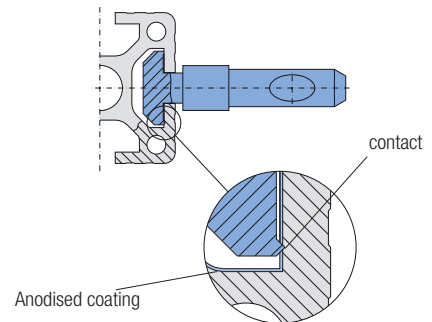

Deliverable types ↗ Connectors 1.2A
Ground connections ↗ 1.70

MayTec screw-type connector

The MayTec screw-type connector allows connection to profiles by means of T-Nuts.

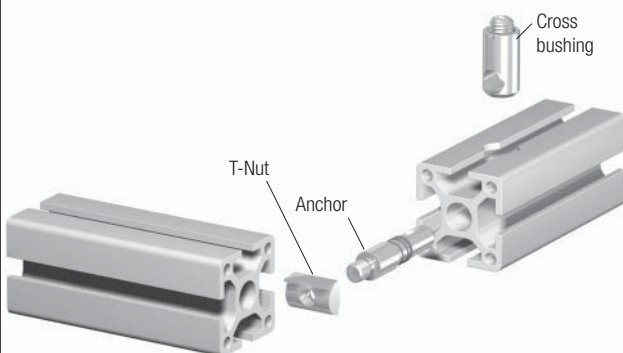

MayTec screw-type connector

The MayTec screw-type connector allows connection to threaded holes in plates.

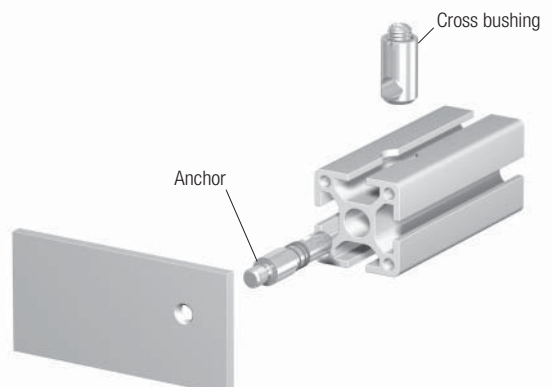

The MayTec Connector System

- mounting of connector in core hole
- with machining

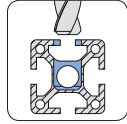

Cross
bushing bore

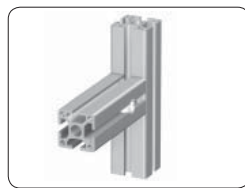
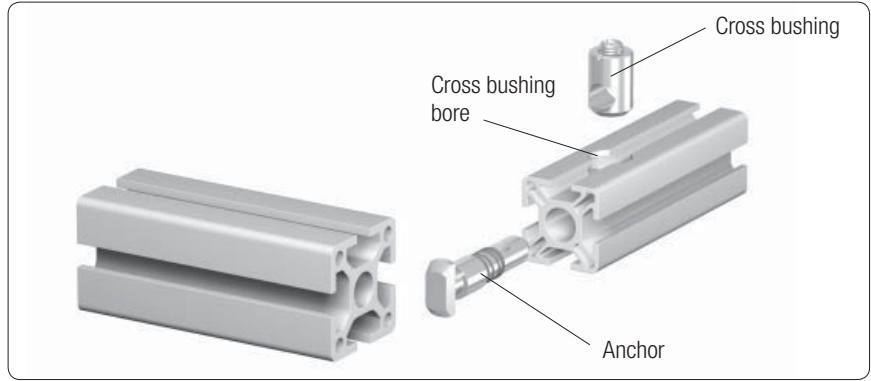

Standard ↗ 92

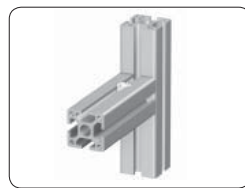

Screw-type ↗ 91, 96

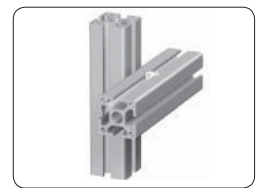

Parallel ↗ 90, 94



Oblique ↗ 90, 92

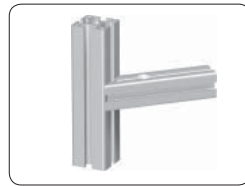

Oblique-cross ↗ 93

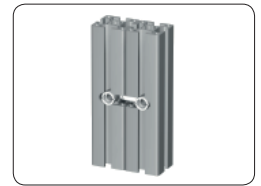

Extension / Parallel ↗ 107



Miter ↗ 90, 95



Shifter ↗ 95



Extension ↗ 90, 94

Anti-twist devices

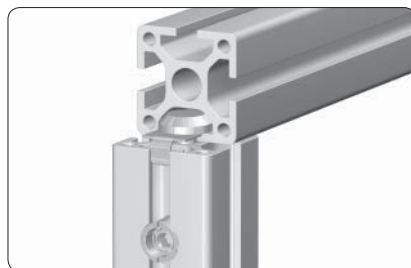

with retaining plate ↗ 131



with T-Nut ↗ 141-144

Clamping lever for connectors



Clamping lever ↗ 134

The MayTec Connector System

- mounting of connector in slot
- with machining

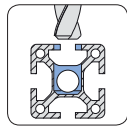

Cross bushing bore

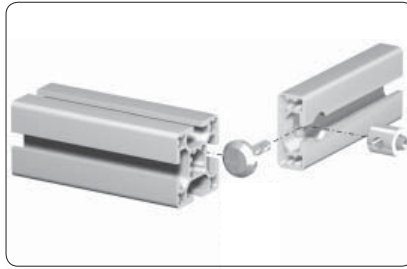

SE-Connector ↗ 109

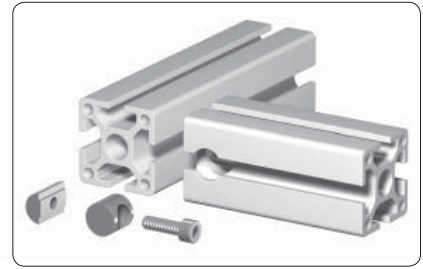

ST-Connector ↗ 110-111



Screw-type connections

- with machining

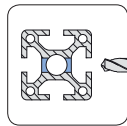
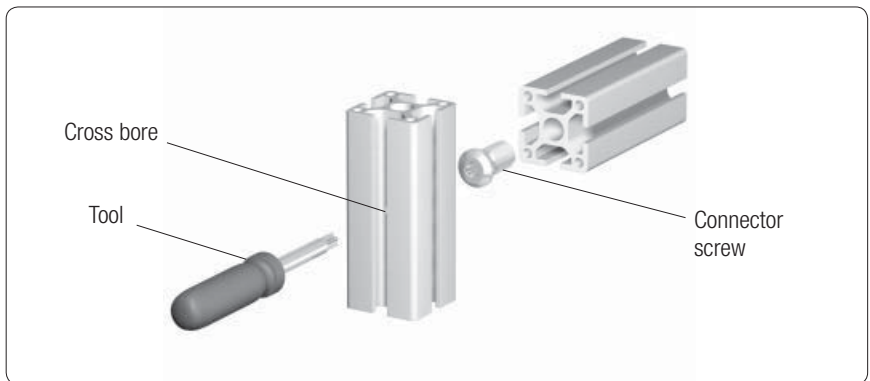

Cross bore

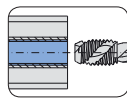

Thread

Threaded insert with lens head screw
↗ 1.35

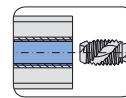

Thread

Connector screw
↗ 97

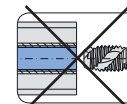

Thread

Connector screw, self-cutting
↗ 97, 112

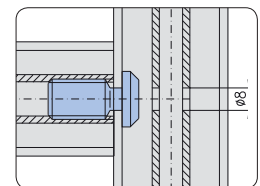
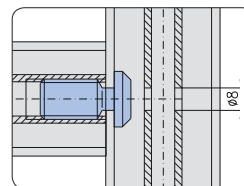
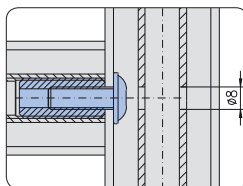

Clamping connections

- with machining

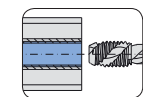
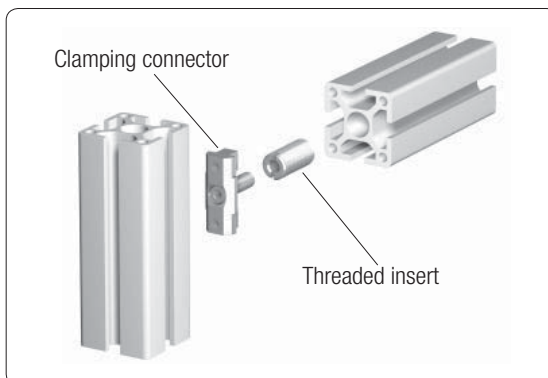

Thread

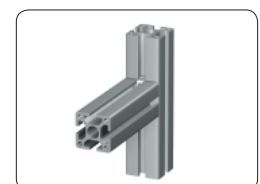

Clamping connector
↗ 117

The MayTec Connector System

- Parallel connector
- without machining

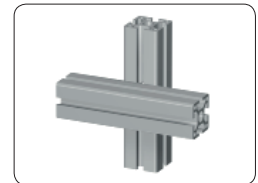
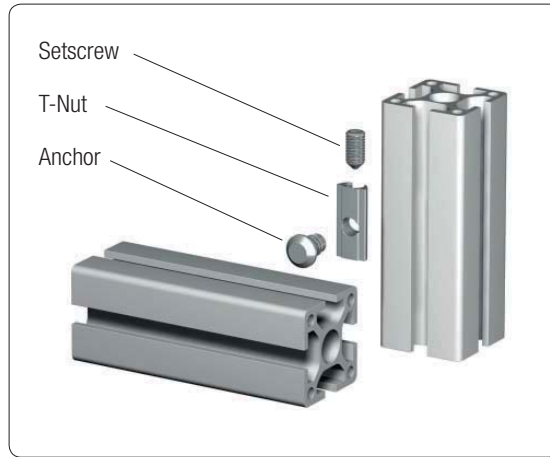

Parallel connector  116

Bayonet type connections
 • without machining

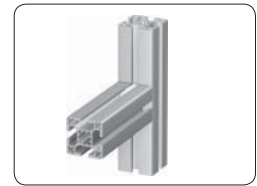
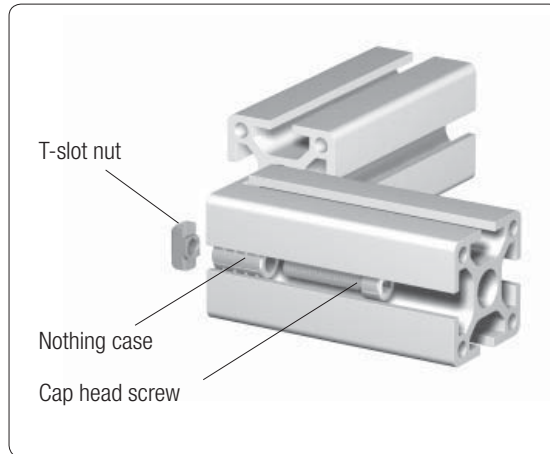

Standard ↗ ↘ 113-114

Cross connections
 • without machining

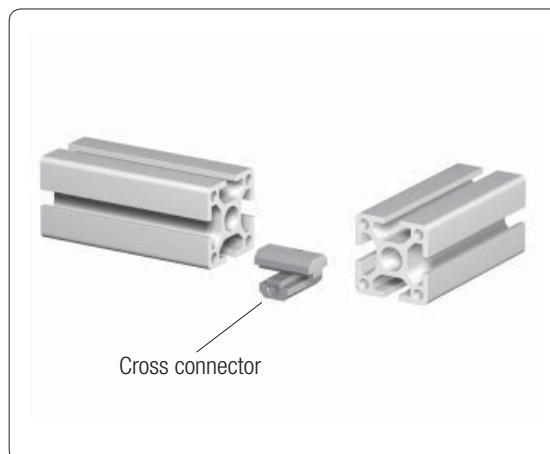

Cross connector ↗ ↘ 115

Angle connections
 • without machining

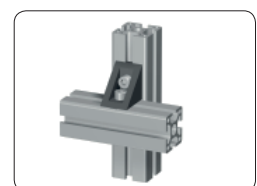
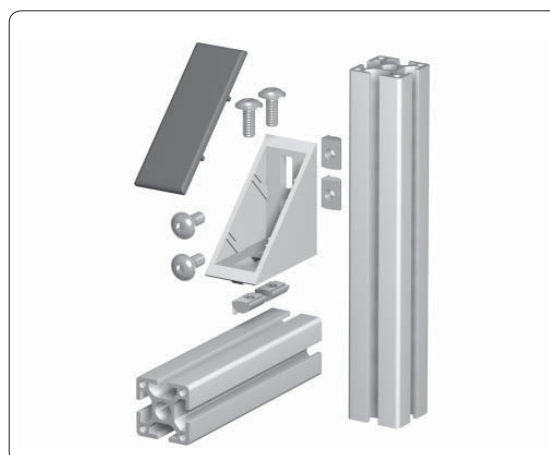

Angle PA ↗ ↘ 1.46

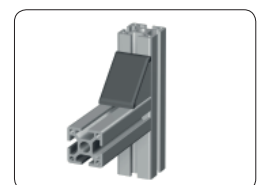

Angle GD-Zn, GD-Al
 ↗ ↘ 1.46

Manufacture a connection



Example

Connection of two profiles 40x40 with one standard connector

1. Connector selection

➤ 1.2, Connector selection

2. Profile machining

➤ 1.1A, Profile machining

➤ 1.99, Tools

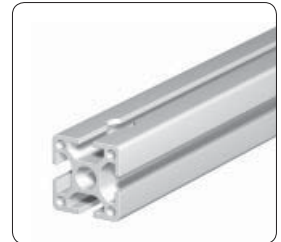
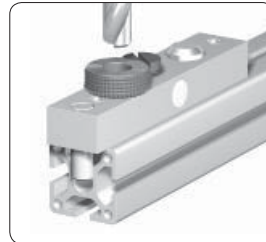

Manufacture the cross bushing bore with the aid of a drill jig

3. Pre-assembly of the connector

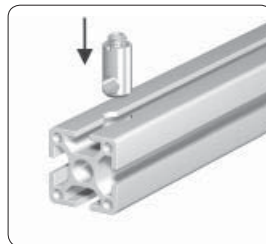

Insert the cross bushing

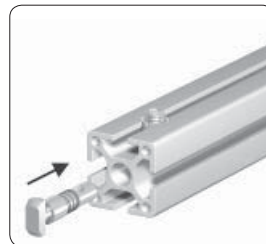

Push in the anchor

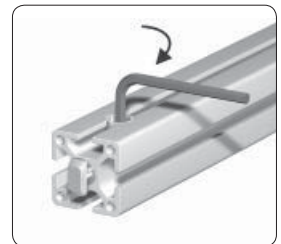

Pretension the anchor

⚠ Mounting position

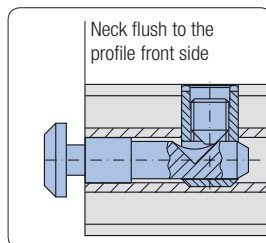

Comments

For the optimal assembly of the profiles the connector is to be installed in such a way that the neck is flush to the profile front side

4. Final assembly

➤ 1.2F, Torque tightening values for connector setscrew

①

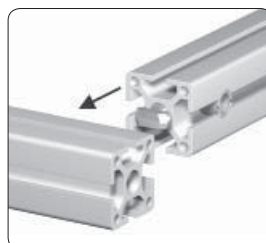

Push in sideways

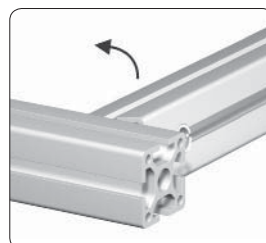

Turn the profile

or

②

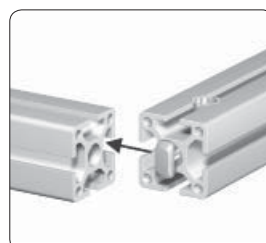

Push in front sided

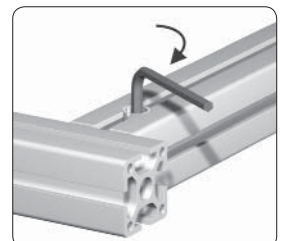

Tighten the setscrew

Connector selection		
Procedure		Example
① Connection	Selection of connector-variant	Standard
② Profile 1	Size of the profile in which the connector should be built into	30×30 mm
③ Core hole	Determination of the core hole Ø	Ø12 mm
④ Profile 2	Determination of the connector-head according to slot-variant of the profile on which it will be joined	40×40 mm / E-slot
⑤ Connector	Determination of connector	1.21.3E1
⑥ Number of degrees	Bent anchor: determine the angle (0° - 45°)	

Connector types and materials		
Connector	Article-No.	Technical data
Standard	1.21.2E0	material: steel strength: ≥ 650 N/mm ² surface: galvanised
Standard, ground	1.21.2E0 E	
Standard VA	1.21.2E0 V	material: stainless steel 1.4305 strength: 490-685 N/mm ² surface: pickled and passivated

Special cases				
Profile	Mounting position	PG for connector selection	Mounting position	PG for connector selection
20×30 30×50		20 30		30 50
30×100		30		50

MayTec®		Connectors for profiles with core hole-Ø 12 mm		1.2A							
Connection / Connector	Finished dimension	PG	Article-No. for connector with								
			H-head		F-head		E-head				
			steel standard	E	VA	steel standard	E	VA	steel standard	E	VA
Universal 		20	1.21.2H0			1.21.2F0	E	V	1.21.2E0	E	V
		30	1.21.3H0			1.21.3F0	E	V	1.21.3E0	E	V
		40	1.21.4H0			1.21.4F0	E	V	1.21.4E0	E	V
		45	1.21.45H0			1.21.45F0	E	V	1.21.45E0	E	V
		50	1.21.50H0			1.21.5F0	E	V	1.21.5E0	E	V
Standard 		20				1.21.2F1	E	V	1.21.2E1	E	V
		30				1.21.3F1	E	V	1.21.3E1	E	V
		40				1.21.4F1	E	V	1.21.4E1	E	V
		45				1.21.45F1	E	V	1.21.45E1	E	V
		50				1.21.5F1	E	V	1.21.5E1	E	V
90° 		20				1.21.2F2	E	V	1.21.2E2	E	V
		30				1.21.3F2	E	V	1.21.3E2	E	V
		40				1.21.4F2	E	V	1.21.4E2	E	V
		45				1.21.45F2	E	V	1.21.45E2	E	V
		50				1.21.5F2	E	V	1.21.5E2	E	V
Square head Universal 		20							1.21.20E40		
		30							1.21.30E40		
		40							1.21.40E40		
		45							1.21.45E40		
		50							1.21.50E40		
Square head Standard 		20				1.21.20F41					
		30					1.21.30F41				

Connection / Connector	Finished dimension	PG	Article-No. for connector with									
			H-head		F-head		E-head					
			steel standard	E	VA	steel standard	E	VA	steel standard	E	VA	
Universal 		20	1.20.2H0		V	1.20.2F0			1.20.2E0			
Oblique -hinge l + r 		20	1.20.2HK1			1.20.2FK1						
Oblique 90° -hinge 		20	1.20.2HK2			1.20.2FK2						
Parallel -square 		20	1.20.2H0		V	1.20.2F0			1.20.2E0			
-cross 												
-high 												

Connection / Connector	Finished dimension	PG	Article-No. for connector		
			steel standard	E	VA
Miter -hinge l + r 		20	1.20.2G1		
Miter 90° -hinge l + r 		20	1.20.2G2		
Extension 		20	1.20.2V0		V

Machining of profiles with core hole-Ø 6 mm for miter

In order not to reduce the strength of the miter joint one profile end must be counterbored

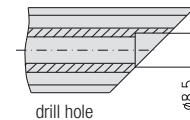

The center portion of the anchor part is to be located in the counterbored profile section

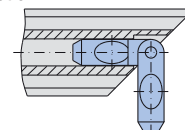



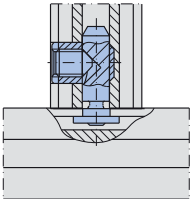
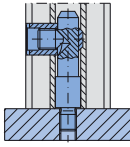
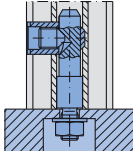



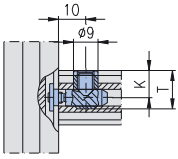
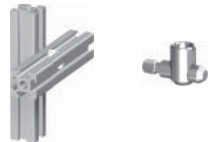
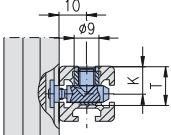
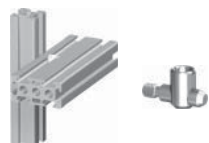
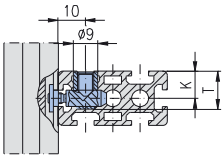
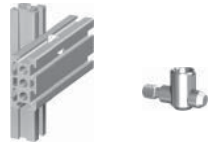
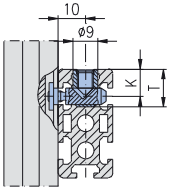

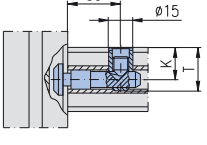
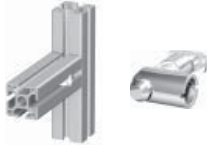
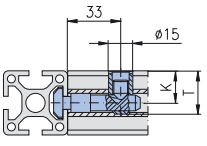

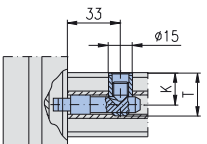

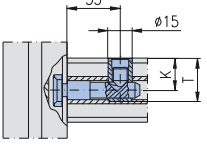
Comments

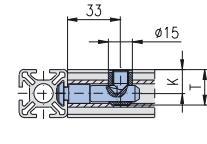

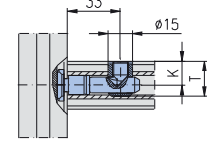

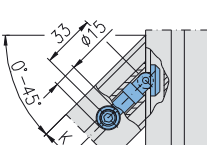

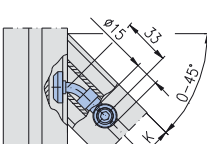

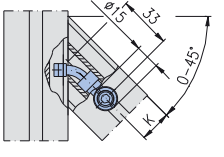

Use drill for miter anchor Article-No.: 1.99.0310800 ↗ tools 1.99

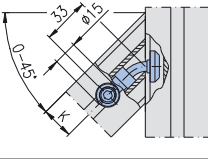
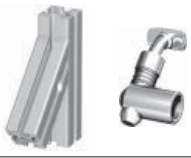
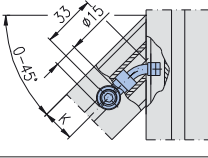
Connection variants with screw-type connectors		
		
Profile with profile	Profile to plate with thread	Profile to plate with through-hole

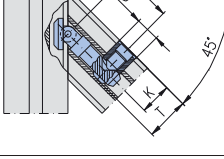

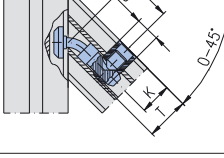
Mounting instruction for screw-type connectors
<ol style="list-style-type: none"> 1. Screw anchor in until it stops against the shoulder 2. Unscrew anchor until it lines-up with the cross bushing position (max. one turn) 3. Set up profile with cross bushing

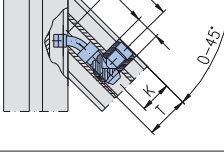
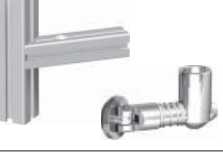
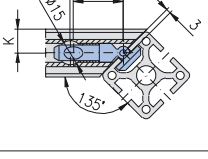
Connection / Connector	Finished dimension	PG	thread	Article-No. for connector	
				steel standard	VA E
Screw-type front sided 		20	M4×7	1.20.2S2M4/7	V
			M5×7	1.20.2S2M5/7	
			M6×7	1.20.2S2M6/7	
Screw-type parallel -square 					
-cross 					
-high 					

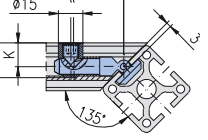

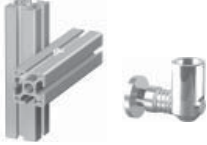
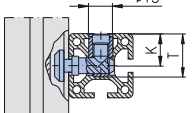
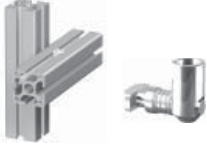
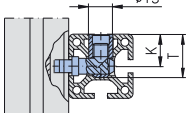
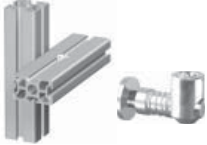
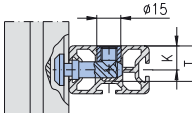
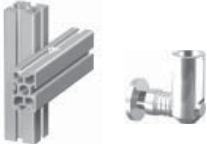
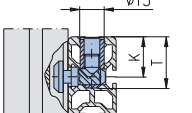
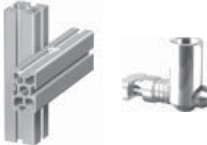
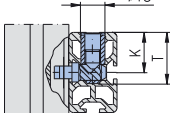

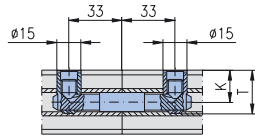

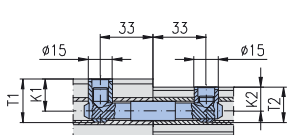

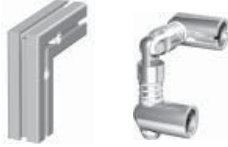
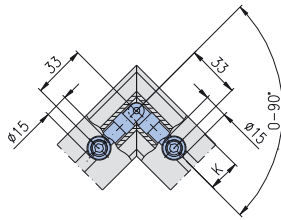
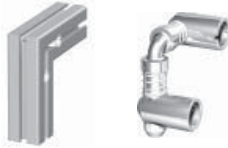
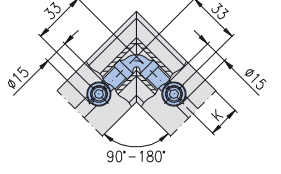

Connection / Connector	Finished dimension	PG	Article-No. for connector with								
			H-head		F-head				E-head		
			steel standard	E	VA	steel standard	E	VA	steel standard	E	VA
Universal 		20	1.21.2H0			1.21.2F0	E	V	1.21.2E0	E	V
		30	1.21.3H0			1.21.3F0	E	V	1.21.3E0	E	V
		40	1.21.40H0			1.21.4F0	E	V	1.21.4E0	E	V
		45	1.21.45H0			1.21.45F0	E	V	1.21.45E0	E	V
		50	1.21.50H0			1.21.5F0	E	V	1.21.5E0	E	V
		60	1.21.60H0			1.21.6F0	E	V	1.21.6E0	E	V
Standard 		20				1.21.2F1	E	V	1.21.2E1	E	V
		30				1.21.3F1	E	V	1.21.3E1	E	V
		40				1.21.4F1	E	V	1.21.4E1	E	V
		45				1.21.45F1	E	V	1.21.45E1	E	V
		50				1.21.5F1	E	V	1.21.5E1	E	V
		60				1.21.6F1	E	V	1.21.6E1	E	V
90° 		20				1.21.2F2	E	V	1.21.2E2	E	V
		30				1.21.3F2	E	V	1.21.3E2	E	V
		40				1.21.4F2	E	V	1.21.4E2	E	V
		45				1.21.45F2	E	V	1.21.45E2	E	V
		50				1.21.5F2	E	V	1.21.5E2	E	V
		60				1.21.6F2	E	V	1.21.6E2	E	V
Square head Universal 		20							1.21.20E40		
		30							1.21.30E40		
		40							1.21.40E40		
		45							1.21.45E40		
		50							1.21.50E40		
		60							1.21.60E40		
Square head Standard 		20				1.21.20F41					
		30				1.21.30F41					
		40				1.21.40F41					
		45				1.21.45F41					
		50				1.21.50F41					
		60				1.21.60F41					
90° 		20				1.21.20F42					
		30				1.21.30F42					
		40				1.21.40F42					
		45				1.21.45F42					
		50				1.21.50F42					
		60				1.21.60F42					
Oblique -hinge l + r 		20				1.21.2FK1		V	1.21.2EK1		V
		30				1.21.3FK1		V	1.21.3EK1		V
		40				1.21.4FK1		V	1.21.4EK1		V
		45				1.21.45FK1		V	1.21.45EK1		V
		50				1.21.5FK1		V	1.21.5EK1		V
		60				1.21.6FK1		V	1.21.6EK1		V
-bent anchor l 		20				1.21.2FB1/□□	E		1.21.2EB1/□□	E	
		30				1.21.3FB1/□□	E		1.21.3EB1/□□	E	
		40				1.21.4FB1/□□	E		1.21.4EB1/□□	E	
		45				1.21.45FB1/□□	E		1.21.45EB1/□□	E	
		50				1.21.5FB1/□□	E		1.21.5EB1/□□	E	
		60				1.21.6FB1/□□	E		1.21.6EB1/□□	E	

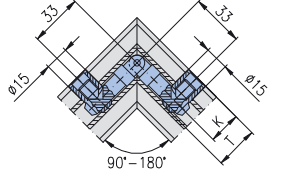
Connection / Connector	Finished dimension	PG	Article-No. for connector with								
			H-head		F-head				E-head		
			steel standard	E	steel standard	E	VA	steel standard	E	VA	
Oblique -bent anchor standard l 		20					1.21.2F1B1L/□□			1.21.2E1B1L/□□	
		30					1.21.3F1B1L/□□			1.21.3E1B1L/□□	
		40					1.21.4F1B1L/□□			1.21.4E1B1L/□□	
		45					1.21.45F1B1L/□□			1.21.45E1B1L/□□	
		50					1.21.5F1B1L/□□			1.21.5E1B1L/□□	
		60					1.21.6F1B1L/□□			1.21.6E1B1L/□□	
-bent anchor r 		20						1.21.2FB1R/□□	E	1.21.2EB1R/□□	E
		30						1.21.3FB1R/□□	E	1.21.3EB1R/□□	E
		40						1.21.4FB1R/□□	E	1.21.4EB1R/□□	E
		45						1.21.45FB1R/□□	E	1.21.45EB1R/□□	E
		50						1.21.5FB1R/□□	E	1.21.5EB1R/□□	E
		60						1.21.6FB1R/□□	E	1.21.6EB1R/□□	E
-bent anchor standard r 		20						1.21.2F1B1R/□□		1.21.2E1B1R/□□	
		30						1.21.3F1B1R/□□		1.21.3E1B1R/□□	
		40						1.21.4F1B1R/□□		1.21.4E1B1R/□□	
		45						1.21.45F1B1R/□□		1.21.45E1B1R/□□	
		50						1.21.5F1B1R/□□		1.21.5E1B1R/□□	
		60						1.21.6F1B1R/□□		1.21.6E1B1R/□□	
Oblique 90° -hinge 		20						1.21.2FK2	V	1.21.2EK2	V
		30						1.21.3FK2	V	1.21.3EK2	V
		40						1.21.4FK2	V	1.21.4EK2	V
		45						1.21.45FK2	V	1.21.45EK2	V
		50						1.21.5FK2	V	1.21.5EK2	V
		60						1.21.6FK2	V	1.21.6EK2	V
-bent anchor 		20						1.21.2FB2/□□	E	1.21.2EB2/□□	E
		30						1.21.3FB2/□□	E	1.21.3EB2/□□	E
		40						1.21.4FB2/□□	E	1.21.4EB2/□□	E
		45						1.21.45FB2/□□	E	1.21.45EB2/□□	E
		50						1.21.5FB2/□□	E	1.21.5EB2/□□	E
		60						1.21.6FB2/□□	E	1.21.6EB2/□□	E
-bent anchor 90° 		20						1.21.2F2B2/□□		1.21.2E2B2/□□	
		30						1.21.3F2B2/□□		1.21.3E2B2/□□	
		40						1.21.4F2B2/□□		1.21.4E2B2/□□	
		45						1.21.45F2B2/□□		1.21.45E2B2/□□	
		50						1.21.5F2B2/□□		1.21.5E2B2/□□	
		60						1.21.6F2B2/□□		1.21.6E2B2/□□	
Oblique-cross-hinge 		20						1.21.2FK3		1.21.2EK3	V
		30						1.21.3FK3		1.21.3EK3	V
		40						1.21.4FK3		1.21.4EK3	V
		45						1.21.45FK3		1.21.45EK3	V
		50						1.21.5FK3		1.21.5EK3	V
		60						1.21.6FK3		1.21.6EK3	V
90° 		20						1.21.2FK4		1.21.2EK4	V
		30						1.21.3FK4		1.21.3EK4	V
		40						1.21.4FK4		1.21.4EK4	V
		45						1.21.45FK4		1.21.45EK4	V
		50						1.21.5FK4		1.21.5EK4	V
		60						1.21.6FK4		1.21.6EK4	V

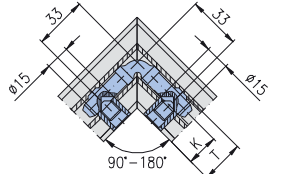
Connection / Connector	Finished dimension	PG	Article-No. for connector with											
			H-head		F-head				E-head					
			steel standard	E	VA	steel standard	E	VA	steel standard	E	VA			
Parallel -square 		20												
		30												
		40				1.21.3F5					1.21.3E5			
		45				1.21.4F5					1.21.4E5			
		50				1.21.45F5					1.21.45E5			
		60				1.21.5F5					1.21.5E5			
-square 90° 		20												
		30												
		40												
		45												
		50												
		60												
-cross 		20												
		30				1.21.2/3F5				1.21.2/3E5				
		40				1.21.3/5F5				1.21.3/5E5				
		45												
		50												
		60												
-high 		20												
		30				1.21.3/2F5				1.21.3/2E5				
		40												
		45												
		50				1.21.5/3F5					1.21.5/3E5			
		60												
-high 90° 		20												
		30												
		40												
		45												
		50												
		60												

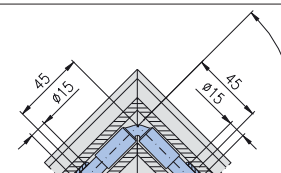
Connection / Connector	Finished dimension	PG, K×2	Article-No. for connector			PG, K×2	Article-No. for connector		
			steel standard	E	VA		steel standard	E	VA
Extension 		20	1.21.2V0		V				
		30	1.21.3V0		V				
		40	1.21.4V0		V				
		45	1.21.45V0		V				
		50	1.21.5V0		V				
		60	1.21.6V0		V				
Extension 		30/20	1.21.3/2V0		V	50/20	1.21.5/2V0		V
		40/20	1.21.4/2V0		V	30	1.21.5/3V0		V
		30	1.21.4/3V0		V	40	1.21.5/4V0		V
		45/20	1.21.45/2V0		V	45	1.21.5/45V0		V
		30	1.21.45/3V0		V	60/20	1.21.6/2V0		V
		40	1.21.45/4V0		V	30	1.21.6/3V0		V
						40	1.21.6/4V0		V
						45	1.21.6/45V0		V
						50	1.21.6/5V0		V

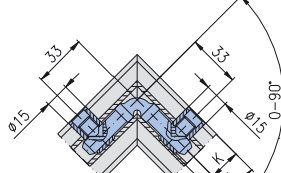
E = ground-connector, VA = stainless steel 1.4305

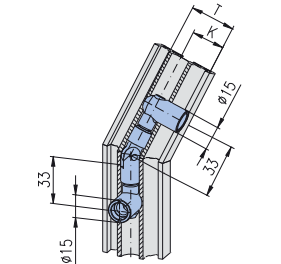
Connection / Connector	Finished dimension	PG	Article-No. for connector		
			steel standard	VA E	
Miter -hinge l + r 		20	1.21.2G1	V	
		30	1.21.3G1	V	
		40	1.21.4G1	V	
		45	1.21.45G1	V	
		50	1.21.5G1	V	
		60	1.21.6G1	V	
-bent anchor l + r 		20	1.21.2GB1/□□		
		30	1.21.3GB1/□□		
		40	1.21.4GB1/□□		
		45	1.21.45GB1/□□		
		50	1.21.5GB1/□□		
		60	1.21.6GB1/□□		
Miter 90° -hinge l + r 		20	1.21.2G2	V	
		30	1.21.3G2	V	
		40	1.21.4G2	V	
		45	1.21.45G2	V	
		50	1.21.5G2	V	
		60	1.21.6G2	V	
-bent anchor l 		20	1.21.2GB2L/□□		
		30	1.21.3GB2L/□□		
		40	1.21.4GB2L/□□		
		45	1.21.45GB2L/□□		
		50			
		60			
			20		
			30		
			40		
			45		
			50	1.21.5GB2L/□□	
			60	1.21.6GB2L/□□	
-bent anchor r 		20	1.21.2GB2R/□□		
		30	1.21.3GB2R/□□		
		40	1.21.4GB2R/□□		
		45	1.21.45GB2R/□□		
		50	1.21.5GB2R/□□		
		60	1.21.6GB2R/□□		
Shifter 		20	1.21.2GS		
		30	1.21.3GS		
		40	1.21.4GS		
		45	1.21.45GS		
		50	1.21.5GS		
		60	1.21.6GS		





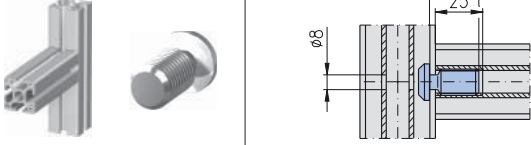
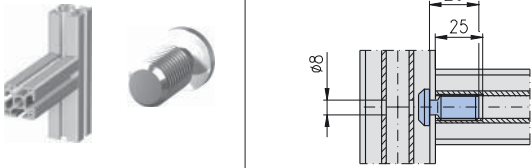

Connection variants with screw-type connectors		
Profile with profile	Profile to plate with thread	Profile to plate with through-hole

Mounting instruction for screw-type connectors
1. Screw anchor in until it stops against the shoulder 2. Unscrew anchor until it lines-up with the cross bushing position (max. one turn) 3. Set up profile with cross bushing

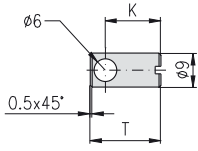
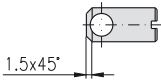
Connection / Connector	Finished dimension	PG	thread	Article-No. for connectors for mounting on profiles with								
				F-slot		E-slot		other				
				Length of thread		Length of thread		Length of thread				
7 mm		11 mm		40 mm								
steel standard	E	VA	steel standard	E	VA	steel standard	E	VA				
Screw-type - front sided 		20	M6				1.21.2S1M6/11					
							1.21.3S1M6/11					
							1.21.4S1M6/11					
							1.21.45S1M6/11					
							1.21.5S1M6/11					
							1.21.6S1M6/11					
		20	M8	1.21.20S1M8/7			1.21.2S1M8/11	V	1.21.2S1M8/40			
				1.21.30S1M8/7			1.21.3S1M8/11	V	1.21.3S1M8/40			
				1.21.40S1M8/7			1.21.4S1M8/11	V	1.21.4S1M8/40			
				1.21.45S1M8/7			1.21.45S1M8/11	V	1.21.45S1M8/40			
				1.21.50S1M8/7			1.21.5S1M8/11	V	1.21.5S1M8/40			
				1.21.60S1M8/7			1.21.6S1M8/11	V	1.21.6S1M8/40			
Screw-type - parallel -square 		20	M8				1.21.2S5M8/11					
							1.21.3S5M8/7			1.21.3S5M8/11		
							1.21.4S5M8/7			1.21.4S5M8/11		
										1.21.45S5M8/11		
										1.21.5S5M8/11		
										1.21.6S5M8/11		
-cross 		20	M8				1.21.2/3S5M8/11					
							1.21.3/5S5M8/11					
-high 		20	M8									
									1.21.3/2S5M8/11			
										1.21.5/3S5M8/11		

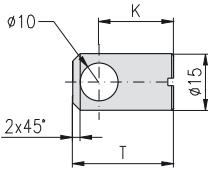
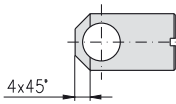
Connection / Connector	Finished dimension	Article-No. for connector with								
		H-head		F-head		E-head				
		steel standard	E	VA	steel standard	E	VA	steel standard	E	VA
Connector screw 					1.21.VSFM14			1.21.VSEM14		
-self-cutting 					1.21.VSFS126S			1.21.VSES126S		
					1.21.VSFS128L			1.21.VSES128L		



Slot type	Cross bushing	Chamfer	Profile	PG	core hole distance	Boring depth, Cross bushing length	Article-No.	
							steel	VA
H-slots								
		0.5x45°	Standard	20	10	14	1.20.B21	V
							1.20.B22	
		1.5x45°	 1.10.020020.21SP	20	10	14		
F + E-slots								
		2x45°	Standard	20	10	17	1.21.B20	V
				30	15	22	1.21.B30	V
				40	20	27	1.21.B40	V
				40	20	27	1.21.B40R	
				45	22.5	29.5	1.21.B45	V
				50	25	32	1.21.B50	V
				60	30	37	1.21.B60	V
		4x45°	 1.11.030100.74SP	20	10	17		
			 1.11.030030.21S(P)  1.11.030150.84SP	30	15	22	1.21.B34	
			 1.11.040040.28LP	40	20	27	1.21.B44	

tools ↗ 1.99, VA = stainless steel 1.4305

Slot type Connector	Cross bushing	PG/ Profile/ Slot	Core hole distance K	Boring depth, Cross bushing length T	Article-No.	
					steel	VA
E-slots						
Special- universal-connector for profile 30×150 ↗ 110		30×150	15	30	1.21.B31	
Special- SE-Connector ↗ 113		16, E3	-	15	1.21.BE3	
		E4	-	16	1.21.BE4	
Special- ST-Connector ↗ 114		E	-	19	1.21.STBM6	
Special- ST-Connector with screw-type anchor ↗ 115		16, E3	-	40	1.21.STSB40	

tools ↗ 1.99, VA = stainless steel 1.4305

Mounting variants

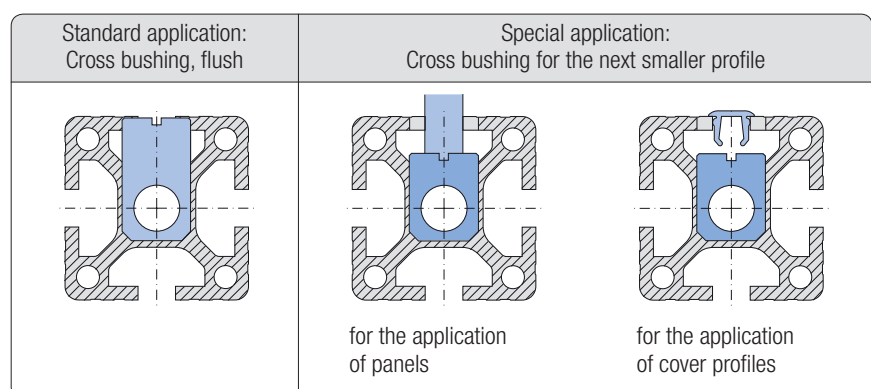



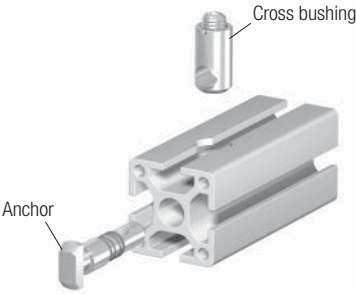











Connector components

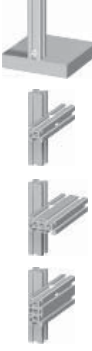

As an alternative to the complete connector it is also possible to order the component parts. Because of the extensive combination possibilities, storage of the complete connectors will be reduced by over 80%.

Connector components for profiles with
 core hole-Ø 6 mm → 101
 core hole-Ø 12 mm → 102-105





Connector for core hole-Ø 6 mm			Connector complete			Single parts					
			PG 20			Anchor		Piece			
			steel standard	E	VA	steel standard	E	VA			
		Universal	1.20.2H0		V	1.20.A2H0		V	1	1	
			1.20.2F0			1.20.A2F0			1	1	
			1.20.2E0			1.20.A2E0			1	1	
		Oblique -hinge l + r	1.20.2HK1			1.20.A2HK1			1	1	
			1.20.2FK1			1.20.A2FK1			1	1	
		90° -hinge	1.20.2HK2			1.20.A2HK2			1	1	
			1.20.2FK2			1.20.A2FK2			1	1	
		Parallel -square ¹⁾	1.20.2H0		V						
			1.20.2F0								
			1.20.2E0								
		-cross ¹⁾	1.20.2H0		V						
			1.20.2F0								
			1.20.2E0								
		-high ¹⁾	1.20.2H0		V						
			1.20.2F0								
			1.20.2E0								
		Miter -hinge l + r	1.20.2G1			1.20.A2G1			1	2	
		90° -hinge l + r	1.20.2G2			1.20.A2G2			1	2	
		Extension	1.20.2V0		V	1.20.A2V0		V	1	2	
		Screw-type	1.20.2S2M4/7		V	1.20.A2S2M4/7		V	1	1	
			1.20.2S2M5/7			1.20.A2S2M5/7			1	1	
			1.20.2S2M6/7			1.20.A2S2M6/7			1	1	
		-Parallel-square ²⁾	1.20.2S2M4/7		V						
			1.20.2S2M5/7								
			1.20.2S2M6/7								
		-Parallel-cross ²⁾	1.20.2S2M4/7		V						
			1.20.2S2M5/7								
			1.20.2S2M6/7								
		-Parallel-high ²⁾	1.20.2S2M4/7		V						
			1.20.2S2M5/7								
			1.20.2S2M6/7								



	Cross bushing, steel	1.20.B21			Cross bushing, steel
	Cross bushing, VA	1.20.B21	V		Cross bushing, VA

E = ground-connector, VA = stainless steel 1.4305

¹⁾ = Connector, universal

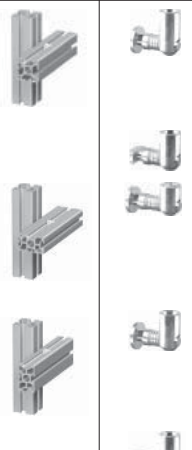
²⁾ = Connector, screw-type

Connector for core hole-Ø 12 mm			Connectors, complete					
			PG 20		PG 30		PG 40	
			steel standard	E	VA steel standard	E	VA steel standard	E
	Universal		1.21.2H0		1.21.3H0		1.21.4H0	
			1.21.2F0	E V	1.21.3F0	E V	1.21.4F0	E V
			1.21.2E0	E V	1.21.3E0	E V	1.21.4E0	E V
	Standard		1.21.2F1	E V	1.21.3F1	E V	1.21.4F1	E V
			1.21.2E1	E V	1.21.3E1	E V	1.21.4E1	E V
	90°		1.21.2F2	E V	1.21.3F2	E V	1.21.4F2	E V
			1.21.2E2	E V	1.21.3E2	E V	1.21.4E2	E V
	Square head	Universal			1.21.20E40		1.21.40E40	
		Standard	1.21.20F41		1.21.30F41		1.21.40F41	
	90°	1.21.20F42		1.21.30F42		1.21.40F42		
	Oblique	-hinge l + r	1.21.2FK1		V 1.21.3FK1		V 1.21.4FK1	
			1.21.2EK1		V 1.21.3EK1		V 1.21.4EK1	
		-bent anchor l	1.21.2FB1L/□□	E	1.21.3FB1L/□□	E	1.21.4FB1L/□□	E
			1.21.2EB1L/□□	E	1.21.3EB1L/□□	E	1.21.4EB1L/□□	E
		-bent a. standard l	1.21.2F1B1L/□□		1.21.3F1B1L/□□		1.21.4F1B1L/□□	
			1.21.2E1B1L/□□		1.21.3E1B1L/□□		1.21.4E1B1L/□□	
		-bent anchor r	1.21.2FB1R/□□	E	1.21.3FB1R/□□	E	1.21.4FB1R/□□	E
			1.21.2EB1R/□□	E	1.21.3EB1R/□□	E	1.21.4EB1R/□□	E
		-bent a. standard r	1.21.2F1B1R/□□		1.21.3F1B1R/□□		1.21.4F1B1R/□□	
			1.21.2E1B1R/□□		1.21.3E1B1R/□□		1.21.4E1B1R/□□	
	90°	-hinge	1.21.2FK2		V 1.21.3FK2		V 1.21.4FK2	
			1.21.2EK2		V 1.21.3EK2		V 1.21.4EK2	
-bent anchor		1.21.2FB2/□□	E	1.21.3FB2/□□	E	1.21.4FB2/□□	E	
		1.21.2EB2/□□	E	1.21.3EB2/□□	E	1.21.4EB2/□□	E	
	-bent anchor 90°	1.21.2F2B2/□□		1.21.3F2B2/□□		1.21.4F2B2/□□		
		1.21.2E2B2/□□		1.21.3E2B2/□□		1.21.4E2B2/□□		
	Oblique-cross	-hinge	1.21.2FK3		1.21.3FK3		1.21.4FK3	
			1.21.2EK3		V 1.21.3EK3		V 1.21.4EK3	
	-hinge 90°	1.21.2FK4		1.21.3FK4		1.21.4FK4		
		1.21.2EK4		V 1.21.3EK4		V 1.21.4EK4		
	Parallel	-square			1.21.3/2F5 ²⁾			
					1.21.3/2E5 ²⁾			
			1.21.2/3F5 ¹⁾		1.21.3F5			
			1.21.2/3E5 ¹⁾		1.21.3E5			
		-square 90°			1.21.3E2-5			
		-cross ¹⁾				1.21.4F5		
						1.21.4E5		
		-high ²⁾			1.21.3/5F5 ¹⁾			
				1.21.3/5E5 ¹⁾				
	-high 90°							



	Cross bushing, steel	1.21.B20		1.21.B30		1.21.B40	
	Cross bushing, VA		1.21.B20	V	1.21.B30	V	1.21.B40

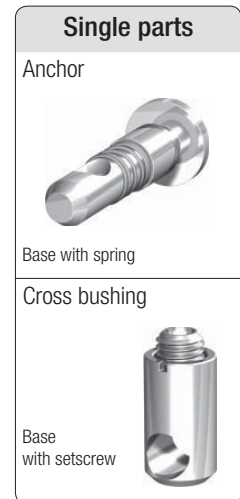

E = ground connector, VA = stainless steel 1.4305

PG 45						PG 50						PG 60						Single parts			
steel standard		VA	steel standard		VA	steel standard		VA	steel standard		VA	Anchor		Piece							
E			E			E			E			steel standard	E	VA							
1.21.45H0			1.21.50H0			1.21.60H0			1.21.A1H0			1.21.A1H0			1	1					
1.21.45F0	E	V	1.21.5F0	E	V	1.21.6F0	E	V	1.21.A1F0	E	V	1.21.A1F0	E	V	1	1					
1.21.45E0	E	V	1.21.5E0	E	V	1.21.6E0	E	V	1.21.A1E0	E	V	1.21.A1E0	E	V	1	1					
1.21.45F1	E	V	1.21.5F1	E	V	1.21.6F1	E	V	1.21.A1F1	E	V	1.21.A1F1	E	V	1	1					
1.21.45E1	E	V	1.21.5E1	E	V	1.21.6E1	E	V	1.21.A1E1	E	V	1.21.A1E1	E	V	1	1					
1.21.45F2	E	V	1.21.5F2	E	V	1.21.6F2	E	V	1.21.A1F2	E	V	1.21.A1F2	E	V	1	1					
1.21.45E2	E	V	1.21.5E2	E	V	1.21.6E2	E	V	1.21.A1E2	E	V	1.21.A1E2	E	V	1	1					
1.21.45E40			1.21.50E40			1.21.60E40			1.21.A1E40			1.21.A1E40			1	1					
1.21.45F41			1.21.50F41			1.21.60F41			1.21.A1F41			1.21.A1F41			1	1					
1.21.45F42			1.21.50F42			1.21.60F42			1.21.A1F42			1.21.A1F42			1	1					
1.21.45FK1		V	1.21.5FK1		V	1.21.6FK1		V	1.21.A1FK1		V	1.21.A1FK1		V	1	1					
1.21.45EK1		V	1.21.5EK1		V	1.21.6EK1		V	1.21.A1EK1		V	1.21.A1EK1		V	1	1					
1.21.45FB1L/□□	E		1.21.5FB1L/□□	E		1.21.6FB1L/□□	E		1.21.A1FB1L/□□	E		1.21.A1FB1L/□□	E		1	1					
1.21.45EB1L/□□	E		1.21.5EB1L/□□	E		1.21.6EB1L/□□	E		1.21.A1EB1L/□□	E		1.21.A1EB1L/□□	E		1	1					
1.21.45F1B1L/□□			1.21.5F1B1L/□□			1.21.6F1B1L/□□			1.21.A1F1B1L/□□			1.21.A1F1B1L/□□			1	1					
1.21.45E1B1L/□□			1.21.5E1B1L/□□			1.21.6E1B1L/□□			1.21.A1E1B1L/□□			1.21.A1E1B1L/□□			1	1					
1.21.45FB1R/□□	E		1.21.5FB1R/□□	E		1.21.6FB1R/□□	E		1.21.A1FB1R/□□	E		1.21.A1FB1R/□□	E		1	1					
1.21.45EB1R/□□	E		1.21.5EB1R/□□	E		1.21.6EB1R/□□	E		1.21.A1EB1R/□□	E		1.21.A1EB1R/□□	E		1	1					
1.21.45F1B1R/□□			1.21.5F1B1R/□□			1.21.6F1B1R/□□			1.21.A1F1B1R/□□			1.21.A1F1B1R/□□			1	1					
1.21.45E1B1R/□□			1.21.5E1B1R/□□			1.21.6E1B1R/□□			1.21.A1E1B1R/□□			1.21.A1E1B1R/□□			1	1					
1.21.45FK2		V	1.21.5FK2		V	1.21.6FK2		V	1.21.A1FK2		V	1.21.A1FK2		V	1	1					
1.21.45EK2		V	1.21.5EK2		V	1.21.6EK2		V	1.21.A1EK2		V	1.21.A1EK2		V	1	1					
1.21.45FB2/□□	E		1.21.5FB2/□□	E		1.21.6FB2/□□	E		1.21.A1FB2/□□	E		1.21.A1FB2/□□	E		1	1					
1.21.45EB2/□□	E		1.21.5EB2/□□	E		1.21.6EB2/□□	E		1.21.A1EB2/□□	E		1.21.A1EB2/□□	E		1	1					
1.21.45F2B2/□□			1.21.5F2B2/□□			1.21.6F2B2/□□			1.21.A1F2B2/□□			1.21.A1F2B2/□□			1	1					
1.21.45E2B2/□□			1.21.5E2B2/□□			1.21.6E2B2/□□			1.21.A1E2B2/□□			1.21.A1E2B2/□□			1	1					
1.21.45FK3			1.21.5FK3			1.21.6FK3			1.21.A1FK3			1.21.A1FK3			1	1					
1.21.45EK3		V	1.21.5EK3		V	1.21.6EK3		V	1.21.A1EK3		V	1.21.A1EK3		V	1	1					
1.21.45FK4			1.21.5FK4			1.21.6FK4			1.21.A1FK4			1.21.A1FK4			1	1					
1.21.45EK4		V	1.21.5EK4		V	1.21.6EK4		V	1.21.A1EK4		V	1.21.A1EK4		V	1	1					
									1.21.A2F5			1.21.A2F5			1	1					
									1.21.A2E5			1.21.A2E5			1	1					
			1.21.5/3F5 ²⁾						1.21.A3F5			1.21.A3F5			1	1					
			1.21.5/3E5 ²⁾						1.21.A3E5			1.21.A3E5			1	1					
									1.21.A3E2-5			1.21.A3E2-5			1	1					
									1.21.A4F5			1.21.A4F5			1	1					
									1.21.A4E5			1.21.A4E5			1	1					
1.21.45F5									1.21.A45F5			1.21.A45F5			1	1					
1.21.45E5									1.21.A45E5			1.21.A45E5			1	1					
			1.21.5F5						1.21.A5F5			1.21.A5F5			1	1					
			1.21.5E5						1.21.A5E5			1.21.A5E5			1	1					
						1.21.6F5			1.21.A6F5			1.21.A6F5			1	1					
						1.21.6E5			1.21.A6E5			1.21.A6E5			1	1					
			1.21.5/3E2-5						1.21.A3E2-5			1.21.A3E2-5			1	1					
1.21.B45			1.21.B50			1.21.B60			Cross bushing, steel												
1.21.B45	V		1.21.B50	V		1.21.B60	V		Cross bushing, VA												

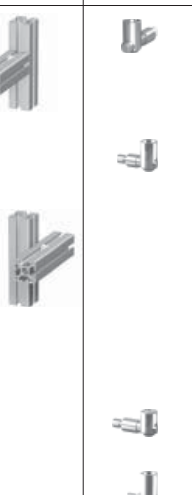

2

Connector for core hole-Ø 12 mm				Connectors, complete							
				PG 20		PG 30		PG 40			
				steel standard	E	VA	steel standard	E	VA	steel standard	E
	Miter	-hinge l + r	1.21.2G1	V	1.21.3G1	V	1.21.4G1	V			
		-bent anchor l + r	1.21.2GB1/□□		1.21.3GB1/□□		1.21.4GB1/□□				
	90°	-hinge l + r	1.21.2G2	V	1.21.3G2	V	1.21.4G2	V			
		-bent anchor l	1.21.2GB2L/□□		1.21.3GB2L/□□		1.21.4GB2L/□□				
		-bent anchor r	1.21.2GB2R/□□		1.21.3GB2R/□□		1.21.4GB2R/□□				
	Shifter		1.21.2GS		1.21.3GS		1.21.4GS				
	Extension		1.21.2V0	V	1.21.3V0	V	1.21.4V0	V			
						1.21.3/2V0	V	1.21.4/2V0 1.21.4/3V0	V V		
	Screw-type	-front sided	1.21.2S1M6/11 1.21.20S1M8/7 1.21.2S1M8/11 1.21.2S1M8/40	V	1.21.3S1M6/11 1.21.30S1M8/7 1.21.3S1M8/11 1.21.3S1M8/40	V	1.21.4S1M6/11 1.21.40S1M8/7 1.21.4S1M8/11 1.21.4S1M8/40			V	
			-Parallel-square	1.21.2S5M8/11		1.21.3S5M8/7 1.21.3S5M8/11		1.21.4S5M8/7 1.21.4S5M8/11			
			-Parallel-cross	1.21.2/3S5M8/11		1.21.3/5S5M8/11					
			-Parallel-high			1.21.3/2S5M8/11					

	Cross bushing, steel	1.21.B20		1.21.B30		1.21.B40	
	Cross bushing, VA	1.21.B20	V	1.21.B30	V	1.21.B40	V

PG 45						PG 50						PG 60						Single parts				
steel standard		E	VA	steel standard		E	VA	steel standard		E	VA	Anchor		Piece	1.21.B20	1.21.B30	1.21.B40	1.21.B45	1.21.B50			
steel standard		E	VA	steel standard		E	VA	steel standard		E	VA	steel standard		E	VA							
1.21.45G1			V	1.21.5G1			V	1.21.6G1			V	1.21.A1G1		V	1	2						
1.21.45GB1/□□				1.21.5GB1/□□				1.21.6GB1/□□				1.21.A1GB1/□□			1	2						
1.21.45G2			V	1.21.5G2			V	1.21.6G2			V	1.21.A1G2		V	1	2						
1.21.45GB2L/□□				1.21.5GB2L/□□				1.21.6GB2L/□□				1.21.A1GB2L/□□			1	2						
				1.21.5GB2R/□□				1.21.6GB2R/□□				1.21.A1GB245L/□□			1	2						
1.21.45GB2R/□□				1.21.5GB2R/□□				1.21.6GB2R/□□				1.21.A1GB2R/□□			1	2						
1.21.45GS				1.21.5GS				1.21.6GS				1.21.A1GS			1	2						
1.21.45V0			V	1.21.5V0			V	1.21.6V0			V	1.21.A1V0		V	1	2	-	-	-	-		
1.21.45/2V0			V	1.21.5/2V0			V	1.21.6/2V0			V	1.21.A1V0		V	1	1	1	-	-	-		
1.21.45/3V0			V	1.21.5/3V0			V	1.21.6/3V0			V	1.21.A1V0		V	1	1	-	1	-	-		
1.21.45/4V0			V	1.21.5/4V0			V	1.21.6/4V0			V	1.21.A1V0		V	1	1	-	-	1	-		
				1.21.5/45V0			V	1.21.6/45V0			V	1.21.A1V0		V	1	1	-	-	-	1		
								1.21.6/5V0			V	1.21.A1V0		V	1	1	-	-	-	-		
1.21.45S1M6/11				1.21.5S1M6/11				1.21.6S1M6/11				1.21.A1SM6/11			1	1						
1.21.45S1M8/7				1.21.5S1M8/7				1.21.6S1M8/7				1.21.A1SM8/7			1	1						
1.21.45S1M8/11			V	1.21.5S1M8/11			V	1.21.6S1M8/11			V	1.21.A1SM8/11		V	1	1						
1.21.45S1M8/40				1.21.5S1M8/40				1.21.6S1M8/40				1.21.A1SM8/40			1	1						
												1.21.A2SM8/11			1	1						
												1.21.A3SM8/7			1	1						
												1.21.A3SM8/11			1	1						
												1.21.A4SM8/7			1	1						
1.21.45S5M8/11												1.21.A4SM8/11			1	1						
				1.21.5S5M8/11				1.21.6S5M8/11				1.21.A45SM8/11			1	1						
												1.21.A5SM8/11			1	1						
												1.21.A6SM8/11			1	1						
												1.21.A3SM8/11			1	1						
												1.21.A5SM8/11			1	1						
												1.21.A2SM8/11			1	1						
				1.21.5/3S5M8/11								1.21.A3SM8/11			1	1						
1.21.B45				1.21.B50				1.21.B60				Cross bushing, steel										
1.21.B45			V	1.21.B50			V	1.21.B60			V	Cross bushing, VA										



Parallel connector
for profile 30×30, soft

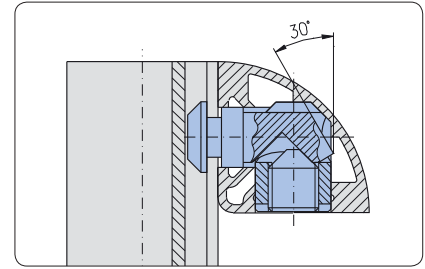
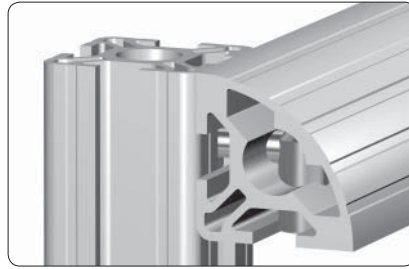

Application

Special anchor for parallel connector for profile 30×30, 2 F-slots, soft

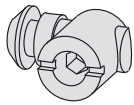

Description

Description	Weight	Article-No.
Connector, parallel	40 g	1.21.31E5
Connector, parallel	33 g	1.21.31F5

Single parts

Description	Weight	Article-No.
Anchor, incl. spring	23 g	1.21.A31E5
Anchor, incl. spring	16 g	1.21.A31F5
Cross bushing, incl. setscrew	17 g	1.21.B34

Universal connector
for profile 30×150

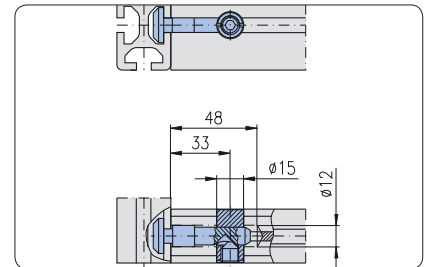
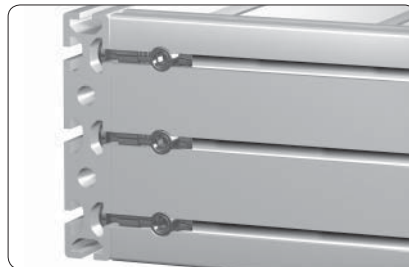

Drill dimensions

Application

Universal connector for connection of two profiles 30×150
Alternative connection possibility
↔ *ST-Connector, 110*

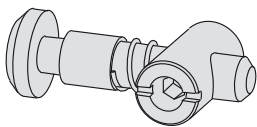

Description

Description	Weight	Article-No.
Connector, universal	68 g	1.21.31E0

Single parts

Description	Weight	Article-No.
Anchor, incl. spring	41 g	1.21.A1E0
Cross bushing, incl. setscrew	27 g	1.21.B31

Extension / parallel connector

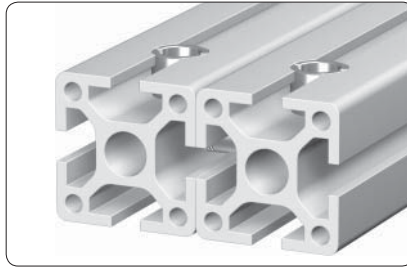

Application

- Parallel connections with core hole distance of 40 mm
- Profile extensions

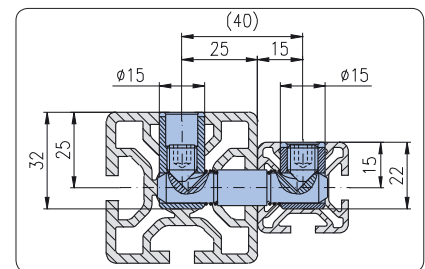
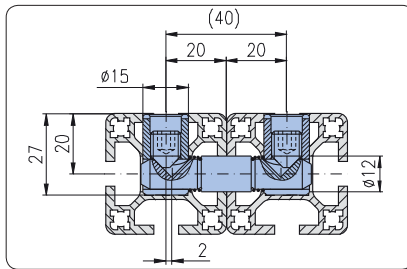

Insert front-sided

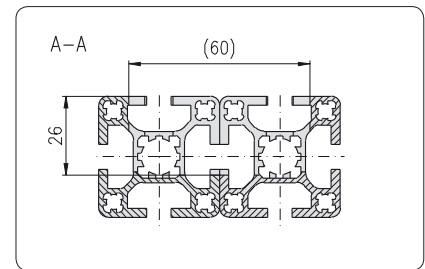

Profile machining

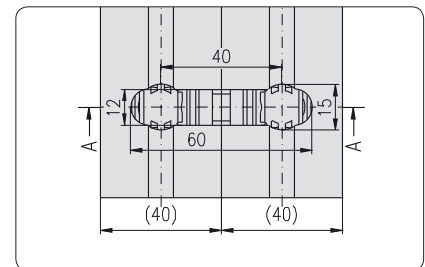

Profile machining

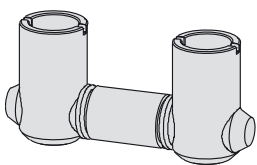

Description	Weight	Article-No.
Connector extension / parallel	76 g	1.21.40V040

Single parts

Description	Pcs	Weight	Article-No.
Anchor for connector extension / parallel, incl. springs	1	36 g	1.21.A1V040
Cross bushing B40, incl. setscrew	2	20 g	1.21.B40

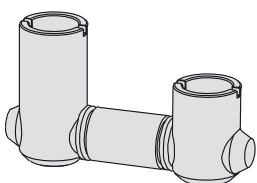



Description	Weight	Article-No.
Connector extension / parallel	76 g	1.21.50/30V040

Single parts

Description	Pcs	Weight	Article-No.
Anchor for connector extension / parallel, incl. springs	1	36 g	1.21.A1V040
Cross bushing B50, incl. setscrew	1	25 g	1.21.B50
Cross bushing B30, incl. setscrew	1	15 g	1.21.B30

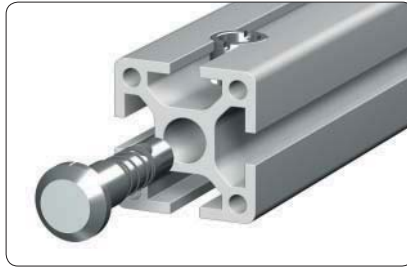
Universal connector
with knurled cross bushing



Application
Fixable cross bushing
Press in device  1.98

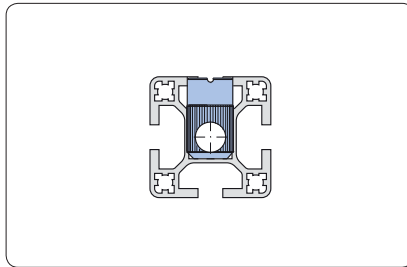

Comments
The knurled cross bushing is suitable for all connectors with the cross bushing 1.21.B40
 Connector components, 1.2C

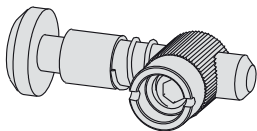

Description	Weight	Article-No.
Connector, universal with knurled cross bushing	60 g	1.21.40RE0

Single parts

Description	Pcs	Weight	Article-No.
Anchor, incl. spring	1	40 g	1.21.A1E0
Cross bushing B40, knurled, incl. setscrew	1	20 g	1.21.B40R

SE-Connector

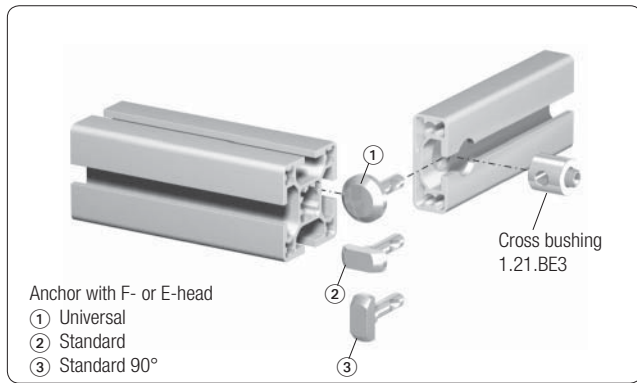

for profiles with E3-slot, PG16, E

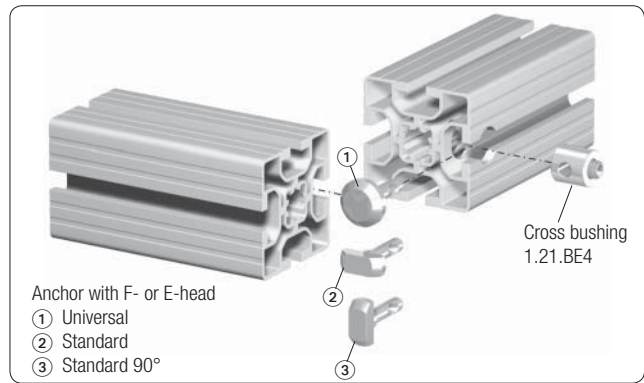

for profiles with E4-slot

Application

- for PG 16 E
- allows mounting of additional profiles into existing frames

Boring depth T	
mounting in	T
E3-slot	15 mm
E4-slot	16 mm

Drill distance L	
mounting on	L
F-slot	16 mm
E3-slot	15 mm
E4-slot	14 mm

Connection		Connection		Connector	Article-No. for SE-connector			
Profile PG16, E3-slot to F/E-slot		Profile with E4-slot to F/E-slot			mounting in E3-slot		mounting in E4-slot	
steel	VA	steel	VA		steel	VA	steel	VA
Universal		Universal			1.21.SE3F0		1.21.SE4F0	
					1.21.SE3E0		1.21.SE4E0	
Standard		Standard			1.21.SE3F1		1.21.SE4F1	
					1.21.SE3E1		1.21.SE4E1	
90°		90°			1.21.SE3F2		1.21.SE4F2	
					1.21.SE3E2		1.21.SE4E2	

Connectors for E3/E4-slot			Connectors, complete						Single parts			
			mounting in E3-slot			mounting in E4-slot			Anchor			Piece
			steel	VA	steel	VA	steel	VA	steel	VA		
		Universal	1.21.SE3F0		1.21.SE4F0		1.21.ASEF0				1	1
			1.21.SE3E0		1.21.SE4E0		1.21.ASEE0				1	1
		Standard	1.21.SE3F1		1.21.SE4F1		1.21.ASEF1				1	1
			1.21.SE3E1		1.21.SE4E1		1.21.ASEE1				1	1
		90°	1.21.SE3F2		1.21.SE4F2		1.21.ASEF2				1	1
			1.21.SE3E2		1.21.SE4E2		1.21.ASEE2				1	1
	Cross bushing		1.21.BE3			1.21.BE4						

E = ground-connector, VA = stainless steel 1.4305



ST-Connector



Application

Connector for mounting into E-slot and for connection of profiles 30×150
Alternative connection possibility
↔ *Universal connector, 106*

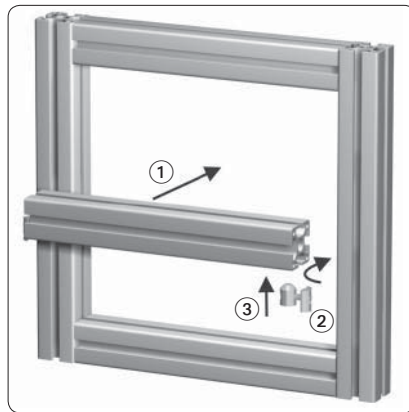

Application

ST-Connector for later insertion of profiles into closed frames

Assembly

- ① push the profile into the frame
- ② insert and rotate the T-Nut, pretension the screw (and cross bushing)
- ③ push the connector into the cross bushing bore, tighten the screw

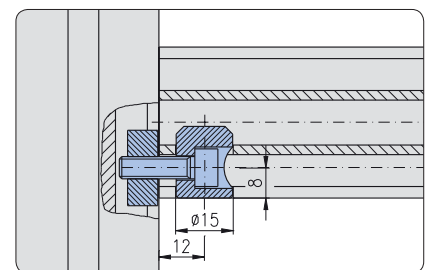
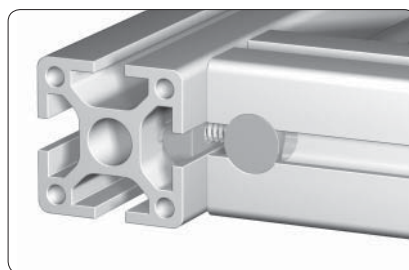
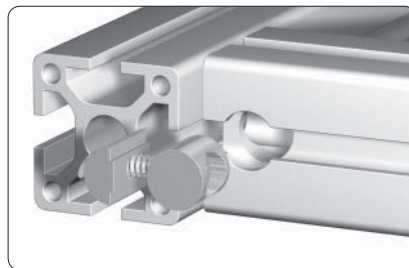

Technical data

material: steel
surface: galvanised
torque: max. 14 Nm
tensile load: max. 5,000 N

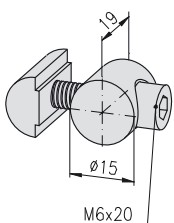

Connector complete

Description	G	Weight	Article-No.
ST-Connector	M6	32.0 g	1.21.STEM620

Single parts

ST-Cross bushing	M6	16.7 g	1.21.STBM6
T-Nut for subsequent insertion into E-slots	M6	10.0 g	1.32.4EM6
Cap head screw DIN 912	M6×20	5.3 g	0.63.D00912.06020

**ST-Connector
with anchor, screw-type**

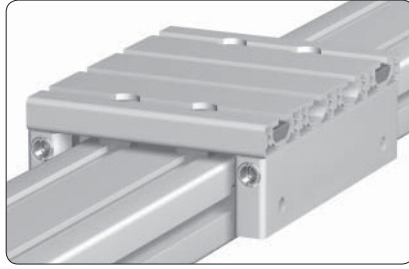

Application

ST-Connection for PG 16, E3-slot
Eco-Slide \rightarrow 1.67

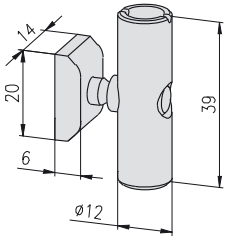
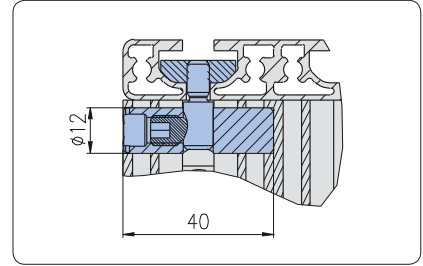
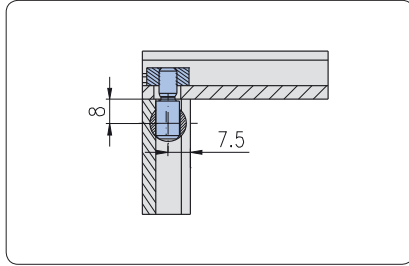

Connector complete

Description	G	Weight	Article-No.
ST-Connector with anchor, screw-type	M6	43.8 g	1.21.STESM6/11

Single parts

ST-Cross bushing		25.4 g	1.21.STSB40
Threaded plate, heavy, E	M6	12.4 g	1.31.7EM6
Anchor, screw-type, for ST-Connector	M6×11	6.0 g	1.21.ASTM6/11

Connector screw self-cutting

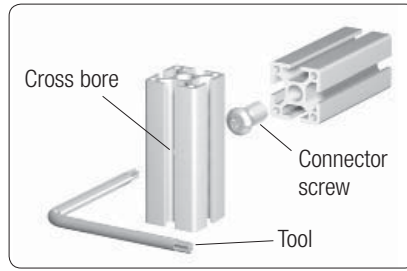

Application

Simple connections with profiles using a 12 mm core hole

Technical data

material: steel 8.8
surface: galvanised

Tool

Tx screw driver for Torx 40 screws
1.98.T40.090090

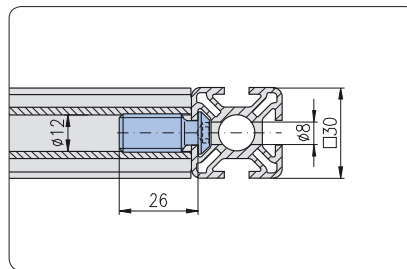
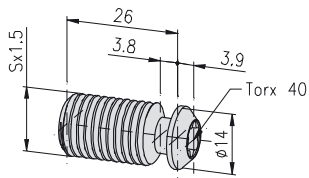

Description	S	Weight	Article-No.
Connector screw, self-cutting, F, S12.8, light		25.0 g	1.21.VSFS128L
Connector screw, self-cutting, F, S12.6, heavy		25.0 g	1.21.VSFS126S

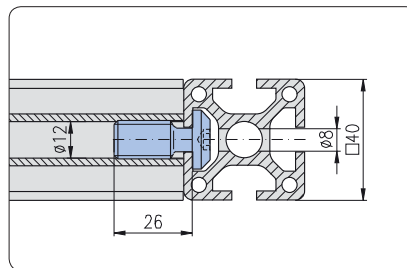
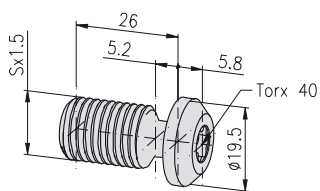

Description	S	Weight	Article-No.
Connector screw, self-cutting, E, S12.8, light		31.5 g	1.21.VSES128L
Connector screw, self-cutting, E, S12.6, heavy		31.5 g	1.21.VSES126S

Bayonet type connector

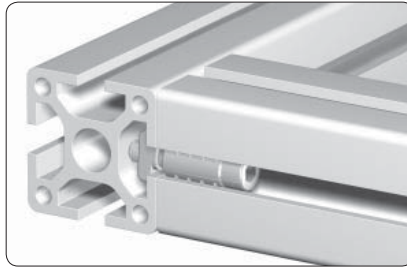

Application

Connection without profile machining.
Suitable for the connection of profiles with E-slots to profiles with E- or F-slots.



Application

Suitable for the subsequent mounting of profiles

Mounting example

for bayonet type connector with T-slot nut

Pre-assembly of the notching case

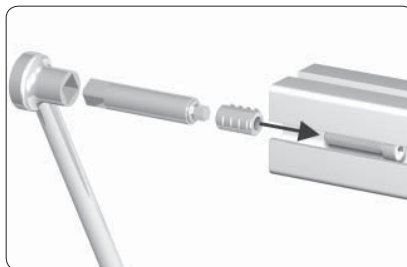

insert the cap head screw and the notching case into the slot

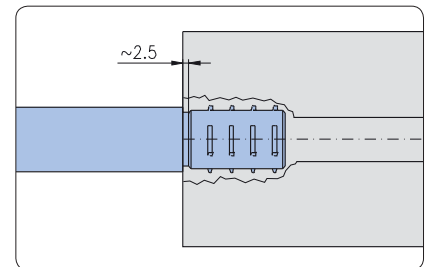

positioning with socket pin

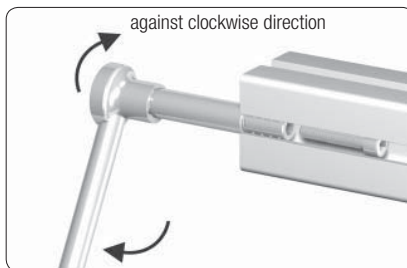

tighten the notching case (approx. 45° anti-clockwise turn)

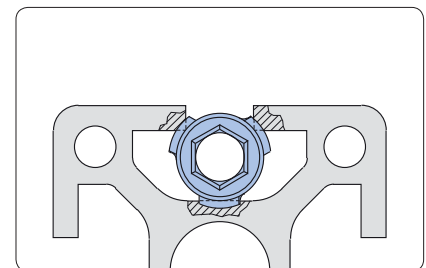

end position of the notching case

Final assembly

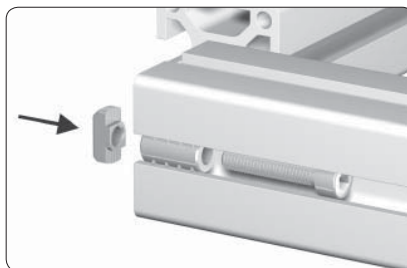

pre-mounting of the T-slot nut

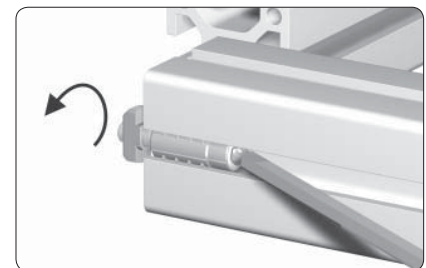

pre-mounting of the T-slot nut

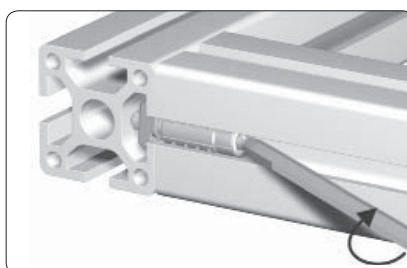

join the profiles and tighten the T-slot nut

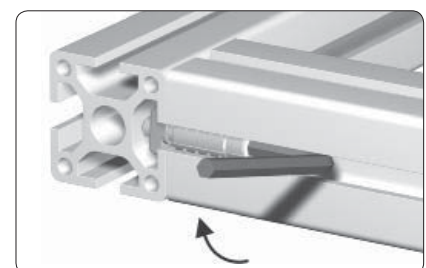

final tightening with socket spanner



Bayonet type connector

Technical data

- Notching case, cap head screw,
T-Nut, socket pin:
material: steel
surface: galvanised
- T-slot nut:
material: GD-Zn

with T-Nut (spring ball)

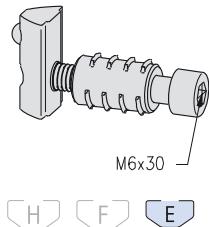

Description	Pcs.	Weight	Article-No.
Bayonet type connector E, with T-Nut (spring ball) E		24.4 g	1.25.E323E

Single parts

Notching case E for bayonet type connector	1	7.5 g	1.25.BE
Cap head screw DIN 912, M6×30	1	8.0 g	0.63.D00912.06030
T-Nut for subs. insertion, with spring ball E, M6	1	9.9 g	1.32.3EM6

with T-Nut (spring)

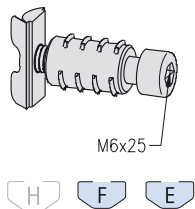

Description	Pcs.	Weight	Article-No.
Bayonet type connector E, with T-Nut (spring) F		18.8 g	1.25.E324F

Single parts

Notching case E for bayonet type connector	1	7.5 g	1.25.BE
Cap head screw DIN 912, M6×25	1	7.0 g	0.63.D00912.06025
T-Nut for subs. insertion, with spring F, M6	1	4.3 g	1.32.4FM6

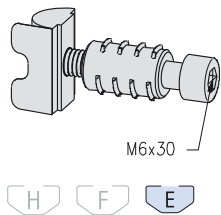

Description	Pcs.	Weight	Article-No.
Bayonet type connector E, with T-Nut (spring) E		25.5 g	1.25.E324E

Single parts

Notching case E for bayonet type connector	1	7.5 g	1.25.BE
Cap head screw DIN 912, M6×30	1	8.0 g	0.63.D00912.06030
T-Nut for subs. insertion, with spring E, M6	1	10.0 g	1.32.4EM6

with T-slot nut

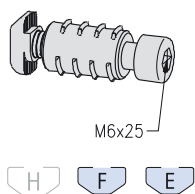

Description	Pcs.	Weight	Article-No.
Bayonet type connector E, with T-slot nut F		16.2 g	1.25.E3410F

Single parts

Notching case E for bayonet type connector	1	7.5 g	1.25.BE
Cap head screw DIN 912, M6×25	1	7.0 g	0.63.D00912.06025
T-slot nut F, M6	1	1.7 g	1.34.10FM6

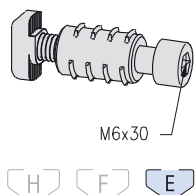

Description	Pcs.	Weight	Article-No.
Bayonet type connector E, with T-slot nut E		18.5 g	1.25.E3410E

Single parts

Notching case E for bayonet type connector	1	7.5 g	1.25.BE
Cap head screw DIN 912, M6×30	1	8.0 g	0.63.D00912.06030
T-slot nut E, M6	1	3.0 g	1.34.10EM6

Socket pin

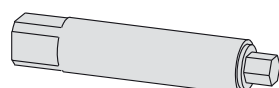

Description	Weight	Article-No.
Socket pin for notching case E	47.0 g	1.25.WZ1

Cross connector



Application

- quick assembly
- connection without profile machining

Technical data

Lower section, upper section, bolt, screw:

material: steel
surface: galvanised

Assembly



push the lower section of the cross connector into the slot of the first profile



slide the slot of the second profile onto the upper section, position the profiles and tighten the connector

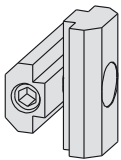

Description

Cross connector E3

Weight

53.5 g

Article-No.

1.25.41.E3

Cross connector E4

55.0 g

1.25.41.E4

Parallel connector
for subsequent insertion



Application

- quick assembly
- connection without profile machining

Assembly



position the setscrew

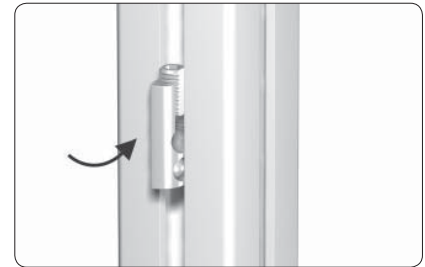

insert the T-Nut



insert and pretension the anchor

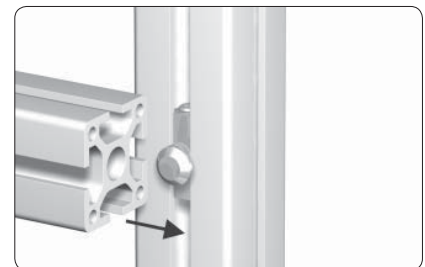

push on and position the profile



fasten the setscrew

Technical data

material: steel
surface: galvanised

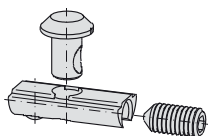

Description	Weight	Article-No.
Parallel connector, for subsequent insertion, E3/H	21.7 g	1.25.E3H/5
Parallel connector, for subsequent insertion, E3/F	24.6 g	1.25.E3F/5
Parallel connector, for subsequent insertion, E3/E3	32.6 g	1.25.E3E3/5
Parallel connector, for subsequent insertion, E4/F	25.0 g	1.25.E4F/5
Parallel connector, for subsequent insertion, E4/E3	33.2 g	1.25.E4E3/5
Parallel connector, for subsequent insertion, E4/E4	33.5 g	1.25.E4E4/5

Clamping connector



Application

- quick assembly
- connection without profile machining

Technical data

material: steel
surface: galvanised

Assembly

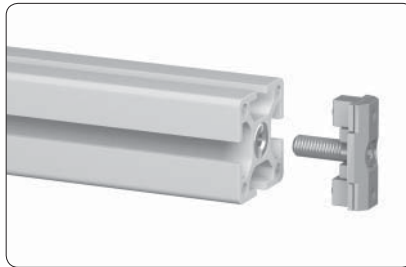

Fastening element

Threaded insert M14/M8, 30, 1.35.1140830

screw the threaded insert M14/M8, 30 into the core hole Assembly reference 1.35

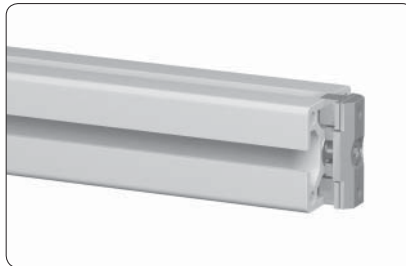

screw the clamping connector into the threaded insert

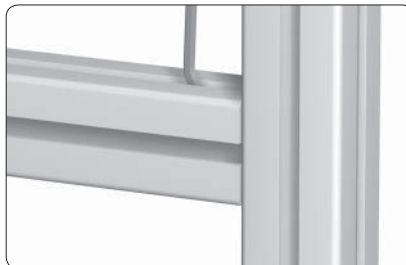

slide the connector into the slot of the second profile, position the profiles and tighten the connector

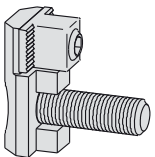

H F E

Description

Description	Weight	Article-No.
Clamping connector 40E, single sided	34.4 g	1.25.61.40E
Clamping connector 45E, single sided	31.8 g	1.25.61.45E

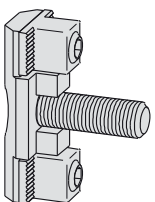

H F E

Description

Description	Weight	Article-No.
Clamping connector 40E, double sided	43.9 g	1.25.62.40E
Clamping connector 45E, double sided	42.3 g	1.25.62.45E

Connection of
0-slot profiles

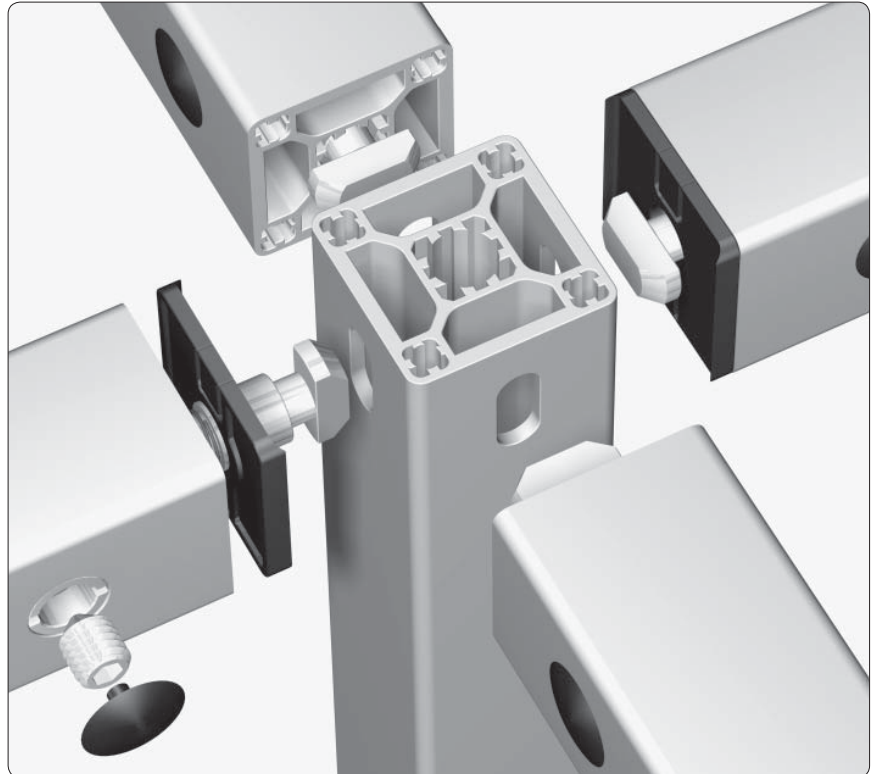

Comments
Connector ↗ 1.2A

Connector - drill dimensions

without radius covers

PG 30	PG 40
<p>Drill dimensions without radius covers</p>	<p>Drill dimensions without radius covers</p>
<p>Drill dimensions with radius covers</p>	<p>Drill dimensions with radius covers</p>

with radius covers

↗ 1.43

Cover plug

for connector cross bushings

↗ 1.42

PG 30	PG 40

**Specification of milling patterns
for closed profiles**

VB□□□ / □□□□-□□.□	Key
VB□□□ / □□□□-□□.□	Shortcut for " V erbinder- B ohrung"
VB□□□ / □□□□-□□.□	Specification of the milling pattern ¹⁾
VB□□□ / □□□□-□□.□	Number of pattern elements ²⁾
VB□□□ / □□□□-□□.□	Direction of the profile side ↗ 57
VB□□□ / □□□□-□□.□	Distance of the reference point to the left end of the profile [mm]
VB□□□ / □□□□-□□.□	Angle of the connection (in case of VB3 or VB4)

- ¹⁾ 1 = "T" shape milling pattern for standard connector (Standard)
↗ 120
- 2 = upside-down "T" shape milling pattern for standard connector
↗ 121
- 3 = universal shape milling pattern for oblique connections with
universal head ↗ 122
- 4 = upside-down universal shape milling pattern for oblique
connections with universal head ↗ 123
- 5 = elongated hole for connection
- with standard connectors ↗ 124
- with T-nuts ↗ 125
- 6 = half circle for miter 3-way connection ↗ 126

- ²⁾ Specification with "A", "B", "C", same as for the amount of cross
bushing bores ↗ 56

Mounting variation

for profiles with 1 or more connectors, if the profile cannot be rotated

for high sliding load

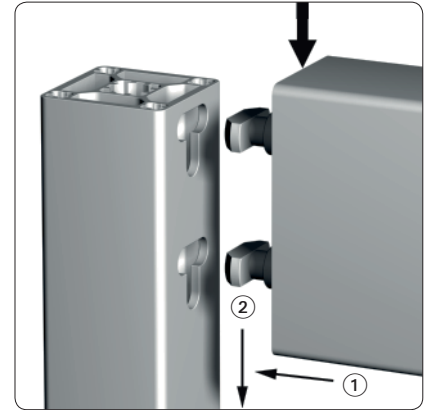
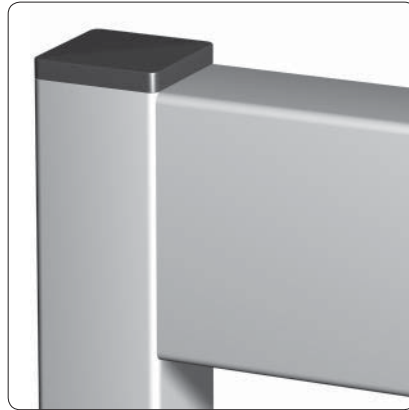

Comments

Position of assembly: profiles flush on the top

Assembly

- ① insert connector
- ② push profile to the bottom

Fabrication measurements

PG 30	PG 40	PG 45
<p>For fastening of profile 30×30</p>	<p>For fastening of profile 40×40</p>	<p>For fastening of profile 45×45</p>
Machining data VB1A□/□□□□		
<p>For fastening of profile 30×60</p>	<p>For fastening of profile 40×80</p>	<p>For fastening of profile 45×90</p>
Machining data VB1B□/□□□□		
<p>For fastening of profile 60×60</p>	<p>For fastening of profile 80×80</p>	<p>For fastening of profile 90×90</p>
Machining data VB1D□/□□□□		

Mounting variation

for profiles with 1 or more connectors, if the profile cannot be rotated

for high flexure load

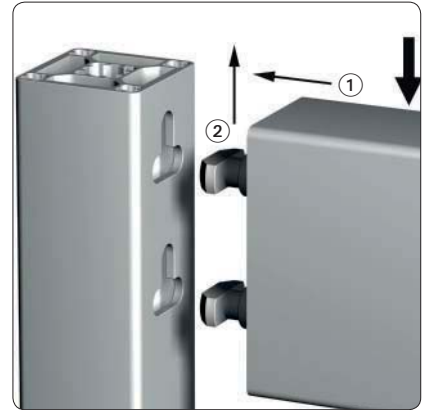
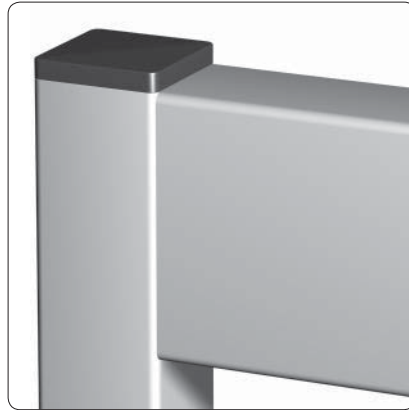

Comments

Position of assembly: profiles flush on the top

Assembly

- ① insert connector
- ② push profile to the top

Fabrication measurements

PG 30	PG 40	PG 45
<p>For fastening of profile 30×30</p>	<p>For fastening of profile 40×40</p>	<p>For fastening of profile 45×45</p>
Machining data VB2A□/□□□□		
<p>For fastening of profile 30×60</p>	<p>For fastening of profile 40×80</p>	<p>For fastening of profile 45×90</p>
Machining data VB2B□/□□□□		
<p>For fastening of profile 60×60</p>	<p>For fastening of profile 80×80</p>	<p>For fastening of profile 90×90</p>
Machining data VB2D□/□□□□		



Mounting variation

for oblique connections with 1 or more connectors

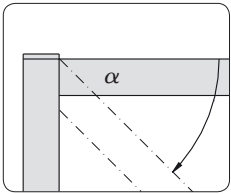

$\alpha = 0 \text{ deg. to } 45 \text{ deg.}$

$$x = \frac{1}{\cos(\alpha)}$$



Comments

Position of assembly: profiles flush on the top

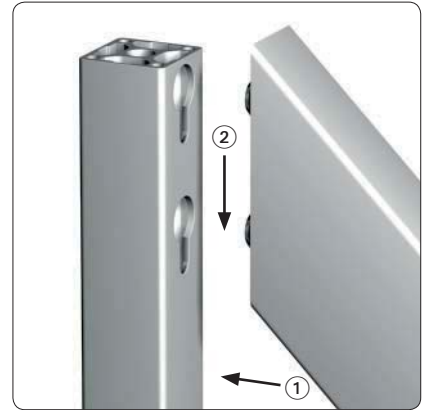

Assembly

- ① insert connector
- ② push profile to the bottom

Fabrication measurements

for the use of oblique hinge connectors with an angle of 0 deg. to 45 deg.

PG 30 for connectors 1.21.3FK1, 1.21.3FK2	PG 40 for connectors 1.21.4EK1, 1.21.4EK2	PG 45 for connectors 1.21.45EK1, 1.21.45EK2
<p>For fastening of profile 30×30</p>	<p>For fastening of profile 40×40</p>	<p>For fastening of profile 45×45</p>
<p>Machining data VB3A□/□□□□-□□.□</p>		
<p>For fastening of profile 30×60</p>	<p>For fastening of profile 40×80</p>	<p>For fastening of profile 45×90</p>
<p>Machining data VB3B□/□□□□-□□.□</p>		
<p>For fastening of profile 80×80</p>	<p>For fastening of profile 90×90</p>	
<p>Machining data VB3D□/□□□□-□□.□</p>		

RP = Reference point; Definition of machining data ↗ 119

Mounting variation

for oblique connections with 1 or more connectors

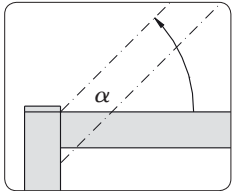

$\alpha = 0 \text{ deg. to } 45 \text{ deg.}$

$$x = \frac{1}{\cos(\alpha)}$$

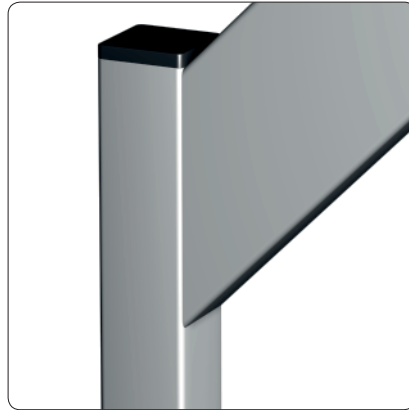

Comments

Position of assembly: profiles flush on the top

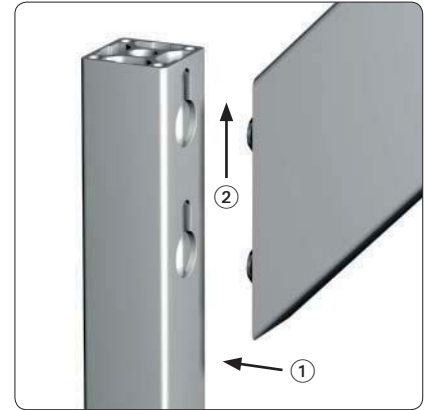

Assembly

- ① insert connector
- ② push profile to the top

Fabrication measurements

for the use of oblique hinge connectors with an angle of 0 deg. to 45 deg.

PG 30 for connectors 1.21.3FK1, 1.21.3FK2	PG 40 for connectors 1.21.4EK1, 1.21.4EK2	PG 45 for connectors 1.21.45EK1, 1.21.45EK2
<p>For fastening of profile 30×30</p>	<p>For fastening of profile 40×40</p>	<p>For fastening of profile 45×45</p>
<p>Machining data VB4A□/□□□□-□□.□</p>		
<p>For fastening of profile 30×60</p>	<p>For fastening of profile 40×80</p>	<p>For fastening of profile 45×90</p>
<p>Machining data VB4B□/□□□□-□□.□</p>		
<p>For fastening of profile 80×80</p>	<p>For fastening of profile 90×90</p>	
<p>Machining data VB4D□/□□□□-□□.□</p>		

Connection with standard connectors

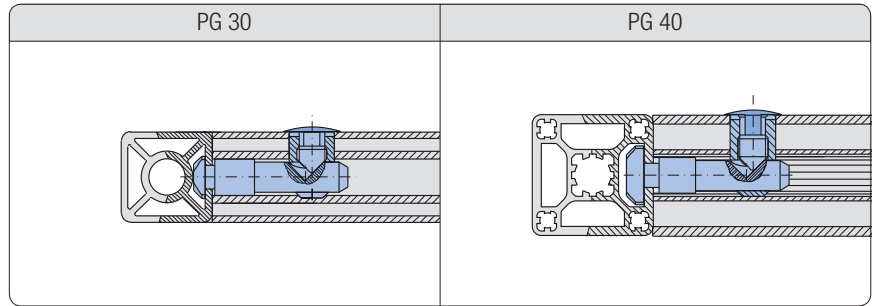

Single parts

Connector, standard 1.21.3F1 (V)
 Connector, standard 90° 1.21.3F2 (V)

Single parts

Connector, standard 1.21.4E1 (V)
 Connector, standard 90° 1.21.4E2 (V)

Mounting variation for profiles with 1 connector

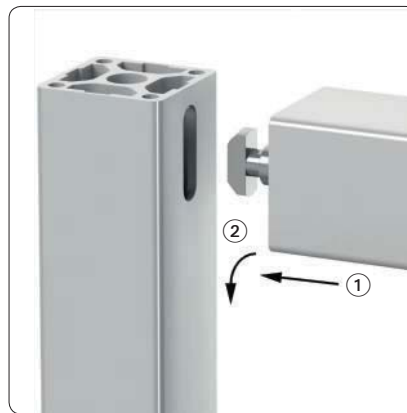

Assembly

- ① insert connector
- ② turn profile

Fabrication measurements

PG 30	PG 40	PG 45
<p>For fastening of profile 30×30</p>	<p>For fastening of profile 40×40</p>	<p>For fastening of profile 45×45</p>
<p>Machining data VB5A□/□□□□</p>		

Connection with screw-type connector

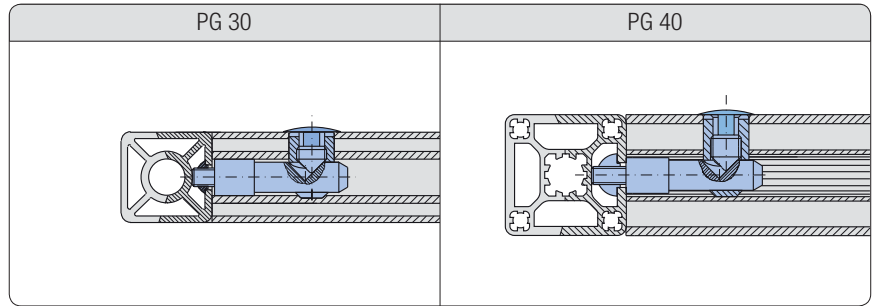

Single parts

- Screw-type connector 1.21.30S1M8/7 (V)
- T-Nut for subsequent insertion, with spring, F 1.32.4FM8 (V)

Single parts

- Screw-type connector 1.21.4S1M8/11 (V)
- T-Nut for subsequent insertion, with spring, E 1.32.4EM8 (V)

Fabrication measurements

PG 30	PG 40	PG 45
<p>For fastening of profile 30×30</p> <p>Machining data VB5A□/□□□□</p>	<p>For fastening of profile 40×40</p> <p>Machining data VB5A□/□□□□</p>	<p>For fastening of profile 45×45</p> <p>Machining data VB5A□/□□□□</p>
<p>For fastening of profile 30×60</p> <p>Machining data VB5B□/□□□□</p>	<p>For fastening of profile 40×80</p> <p>Machining data VB5B□/□□□□</p>	<p>For fastening of profile 45×90</p> <p>Machining data VB5B□/□□□□</p>
<p>For fastening of profile 60×60</p> <p>Machining data VB5D□/□□□□</p>	<p>For fastening of profile 80×80</p> <p>Machining data VB5D□/□□□□</p>	<p>For fastening of profile 90×90</p> <p>Machining data VB5D□/□□□□</p>

Assembly variation

for 3-way connection with miter connectors

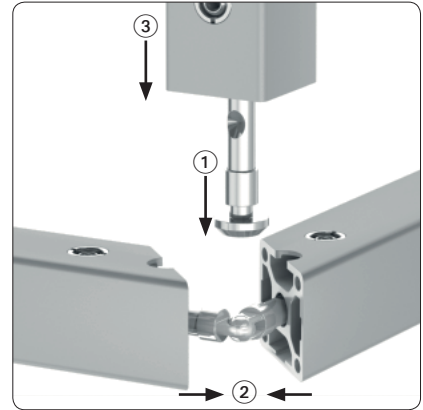

Assembly

- ① Capture anchor head between profiles
- ② Ease profiles together
- ③ Tighten anchors joining profile

Fabrication measurements

PG 30	PG 40
<p>For fastening of profile 30×30</p>	<p>For fastening of profile 40×40</p>
<p>Machining data VB6A□/□□□□-□□.□</p>	
	<p>For fastening of profile 80×80</p>
<p>Machining data VB6B□/□□□□-□□.□</p>	

Connection of profiles 40, round



Drill dimensions for profiles 40, round			
30°		45°	
60°		90°	

Calculation formulas for polygons

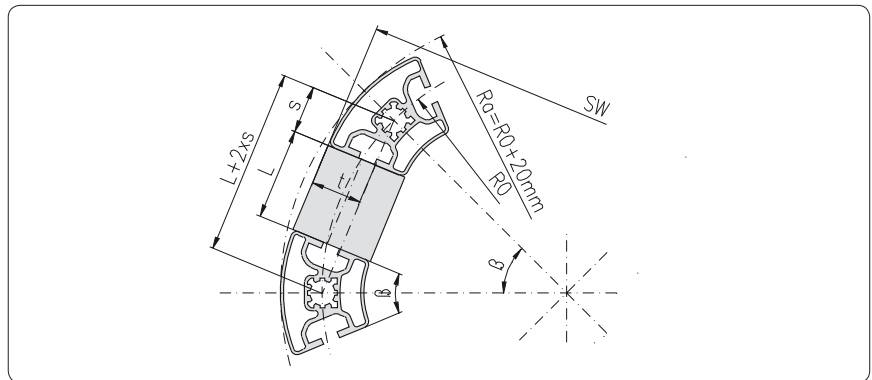

known	searched	Profile 40, round 30° ($\beta = 30^\circ$)	Profile 40, round 45° ($\beta = 45^\circ$)	Profile 40, round 60° ($\beta = 60^\circ$)
		$t = 22.04$ $s = 15.53$	$t = 24.57$ $s = 22.96$	$t = 28.04$ $s = 30.00$
R_0	L =	$R_0 \times 0,51764 - 31,06$	$R_0 \times 0,76537 - 45,92$	$R_0 - 60$
R_a	L =	$(R_a - 20) \times 0,51764 - 31,06$	$(R_a - 20) \times 0,76537 - 45,92$	$R_a - 80$
SW	L =	$\frac{SW - 44,08}{\sqrt{3,73205}} \times 0,51764 - 31,06$	$\frac{SW - 49,14}{\sqrt{3,4142}} \times 0,76537 - 45,92$	$\frac{SW - 56,08}{\sqrt{3}} - 60$
SW	$R_0 =$	$\frac{SW - 44,08}{\sqrt{3,73205}}$	$\frac{SW - 49,14}{\sqrt{3,4142}}$	$\frac{SW - 56,08}{\sqrt{3}}$
SW	$R_a =$	$\frac{SW - 44,08}{\sqrt{3,73205}} + 20$	$\frac{SW - 49,14}{\sqrt{3,4142}} + 20$	$\frac{SW - 56,08}{\sqrt{3}} + 20$
R_0	SW =	$\sqrt{(R_0 \times 2)^2 - (R_0 \times 0,51764)^2 + 44,08}$	$\sqrt{(R_0 \times 2)^2 - (R_0 \times 0,76537)^2 + 49,14}$	$\sqrt{(R_0 \times 2)^2 - R_0^2 + 56,08}$
R_a	SW =	$\sqrt{((R_a - 20) \times 2)^2 - ((R_a - 20) \times 0,51764)^2 + 44,08}$	$\sqrt{((R_a - 20) \times 2)^2 - ((R_a - 20) \times 0,76537)^2 + 49,14}$	$\sqrt{((R_a - 20) \times 2)^2 - R_a^2 + 56,08}$

Subsequent mounting of profiles



Step by step instruction for subsequent mounting of profiles with two standard connections for all profile groups

For the subsequent mounting of the profile:

1. Mill on both ends a slot size of 6×8 mm.

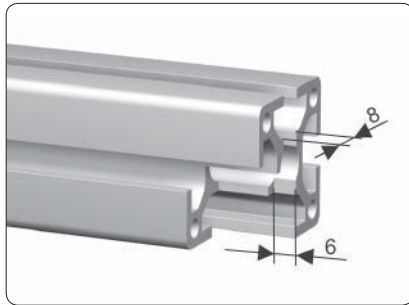

2. Mount connector and fix anchor in front position with setscrew.

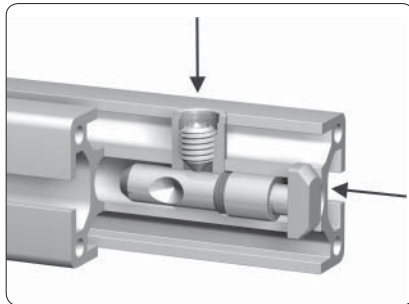

3. Mount profile.

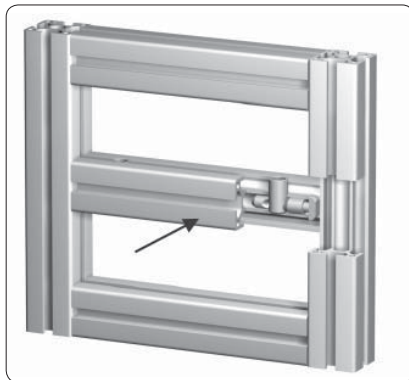

4. Loosen setscrew.

Due to the compressing spring the anchor is pushed into the slot. Turn anchor by 90° with screw driver. Fasten setscrew.

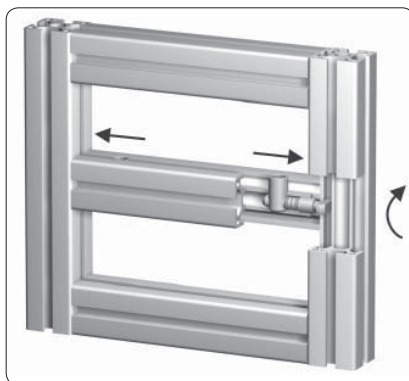

Connection of MayTec with other profile systems

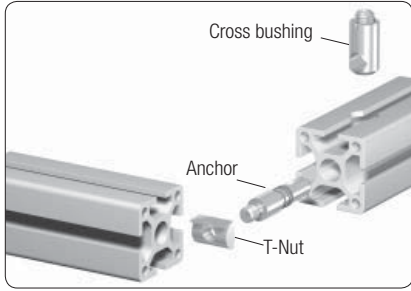

MayTec profiles can easily be combined with other profile systems.

With the MayTec Screw-type connector and the T-Nut of the other profile system

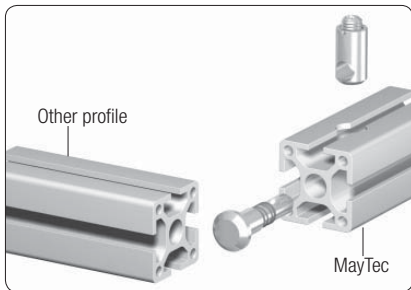
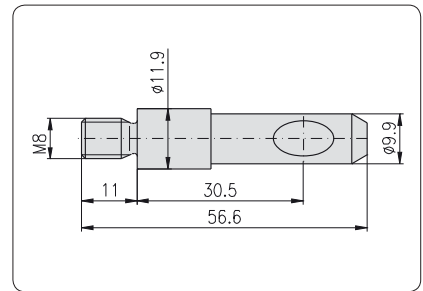
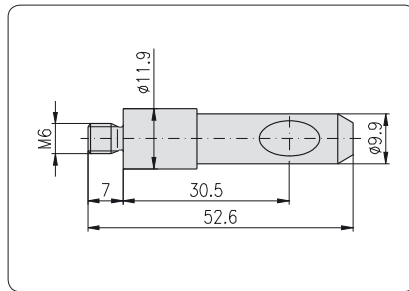
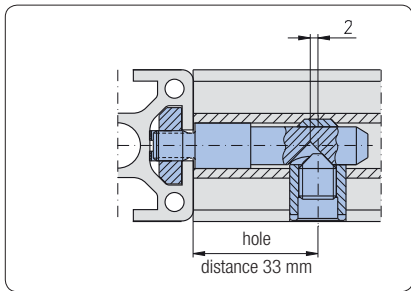
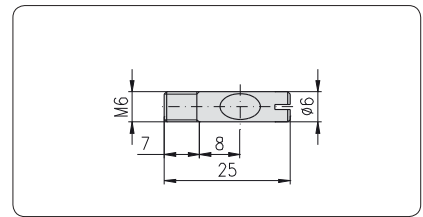
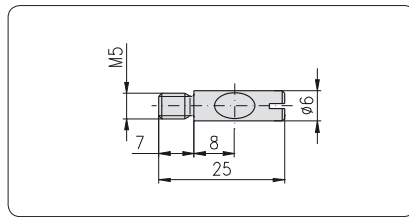
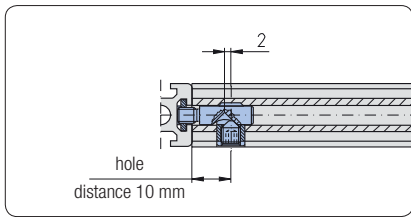

With the MayTec Standard-connector two points have to be considered:

1. Anchor head-form and size

The MayTec system provides 3 anchor head sizes. If any of the sizes don't fit into the slots of other profile systems, the anchor head can be made to fit as required.

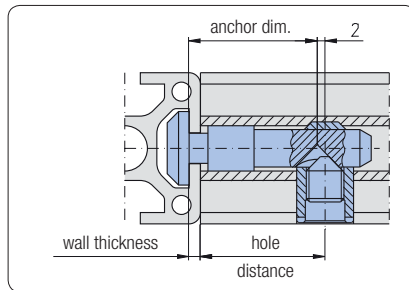

2. Hole distance

During the machining of the cross bore the hole distance has to match the wall thickness of the profile.

$$\text{hole distance} = \text{anchor dim.} - \text{wall thickness} + 2 \text{ mm}$$

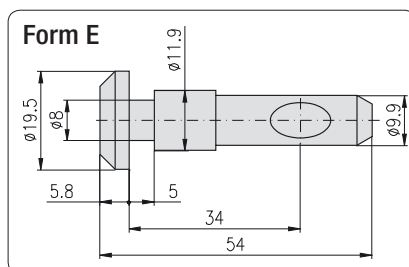
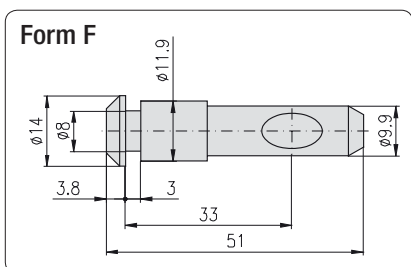
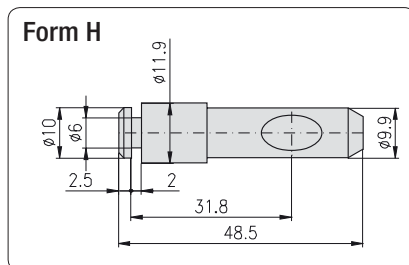
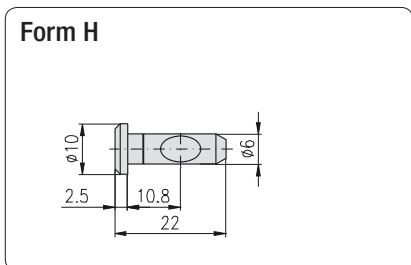

Torque tightening values for connector setscrew

PG	Slot	Setscrew special execution	Torque value	
			recommended	max.
20	H	M6×8	5.0 Nm	6.0 Nm
	F	M8×10	15.0 Nm	20.0 Nm
30	F	M10×12	25.0 Nm	30.0 Nm
40	E	M10×12	30.0 Nm	40.0 Nm
45	E	M10×12	30.0 Nm	40.0 Nm
50	E	M10×12	30.0 Nm	40.0 Nm
60	E	M10×12	30.0 Nm	40.0 Nm

Comments

The max. tightening values are only valid for the MayTec setscrew and can not be reached by the usual commercial quality standard.

Tension load

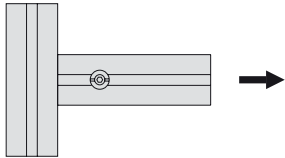

PG	Slot	max. Tensile strength				
		Connector			T-Nut	
		Standard	Universal	Square head		
20	H	-	1,500 N	-	M4	4,000 N
	F	5,000 N	6,000 N	8,000 N	M8	8,000 N
30	F	5,000 N	6,000 N	8,000 N	M8	8,000 N
40	E	10,000 N	12,000 N	12,000 N	M8	12,000 N
45	E	15,000 N	18,000 N	20,000 N	M8	20,000 N
50	E	15,000 N	18,000 N	20,000 N	M8	20,000 N
60	E	15,000 N	18,000 N	20,000 N	M8	20,000 N

Comments

All values given have been tested with pre-tension of the connectors and maximum torque value and refer to the connection of two identical profiles.

Slide load

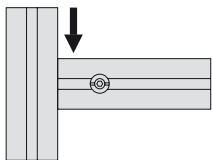

Flexure load

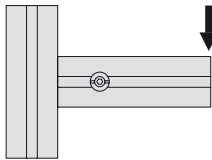

PG	Profile	Slot	Pcs	max. Slide strength		max. Flexure strength		
				Standard, Universal, Square head	E-connector (Standard, Universal)	Connector		
						Standard, Universal, Square head		
20	20×20	H	1	1,500 N	-	50 Nm	100 Nm	150 Nm
	20×40		2	3,000 N	-			
	40×40	F	4	6,000 N	-	300 Nm		65 Nm
	20×30		1	5,000 N	7,500 N			
30	30×30	F	1	5,000 N	7,500 N	100 Nm	100 Nm	160 Nm
	30×50		1	5,000 N	7,500 N			
	30×60	2	10,000 N	15,000 N	200 Nm	400 Nm		
	30×100, 5F	2	10,000 N	15,000 N				
	30×100, 8F	3	15,000 N	22,500 N	300 Nm	960 Nm		
	30×150, 8F	3	15,000 N	22,500 N				
	60×60 angle	3	15,000 N	22,500 N	500 Nm	1,500 Nm		
	60×60	4	20,000 N	30,000 N				
	30×150	E	2	12,000 N	18,000 N	800 Nm	500 Nm	2,000 Nm
	40	40×40	E	1	6,000 N	9,000 N	250 Nm	250 Nm
40×60		1		6,000 N	9,000 N			
40×80		2		12,000 N	18,000 N	500 Nm	1,000 Nm	
40×120		3		18,000 N	27,000 N			
40×160		4		24,000 N	36,000 N	1,000 Nm	4,000 Nm	
80×80 angle		3		18,000 N	27,000 N			
80×80, 8E		4		24,000 N	36,000 N	1,250 Nm	4,500 Nm	
80×120		6		36,000 N	54,000 N			
120×120		8		48,000 N	72,000 N	2,000 Nm	8,000 Nm	
80×160		8		48,000 N	72,000 N			
45	45×45	E	1	6,000 N	9,000 N	360 Nm	360 Nm	480 Nm
	45×60		1	6,000 N	9,000 N			
	45×90		2	12,000 N	18,000 N	2,880 Nm	720 Nm	1,440 Nm
	90×90		4	24,000 N	36,000 N			
50	50×50	E	1	6,000 N	9,000 N	400 Nm	800 Nm	1,600 Nm
	50×100, 6E		2	12,000 N	18,000 N			
	50×100, 8E		3	18,000 N	27,000 N	1,200 Nm	2,400 Nm	
	50×150		3	18,000 N	27,000 N			
	100×100		4	24,000 N	36,000 N	3,200 Nm	6,400 Nm	
	100×200		8	48,000 N	72,000 N			
60	60×60	E	1	6,000 N	9,000 N	480 Nm	960 Nm	1,440 Nm
	60×90		2	12,000 N	18,000 N			

The listed values are valid for all light and heavy profiles

Anti-twist devices

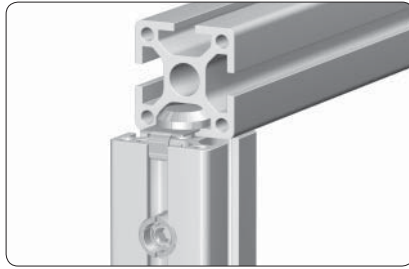

Technical data

material: steel
surface: galvanised

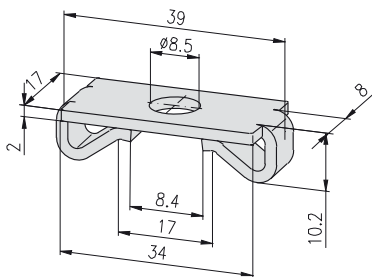

Description

Anti-twist device

Weight

13 g

Article-No.

1.29.11140

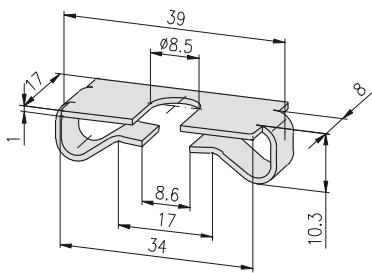

Description

Anti-twist device for connector

Weight

11 g

Article-No.

1.29.11240

Anti-twist devices

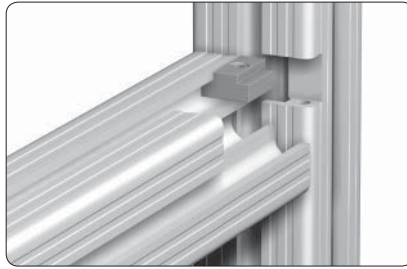

Application

In the case of high torque forces with connections of one connector only, twisting can be prevented by mounting 1 or 2 anti-twist devices.

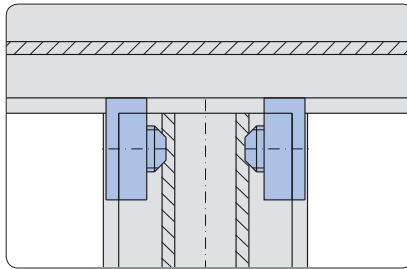

The nose of the anti-twist device fits into the basic profile.

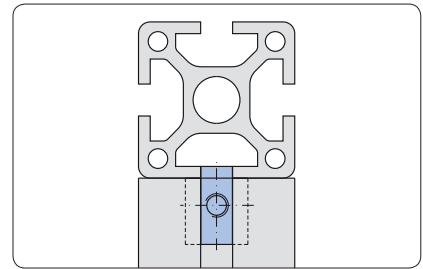

Technical data

material: steel
 surface: galvanised
 max. moment of torque: $M_{A, max}$

Fastening elements

F-slot:
 Setscrew M6×8 1.20.G0608
 E-slot:
 Setscrew M6×12 1.20.G0612

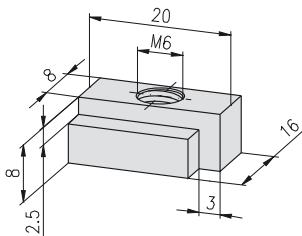
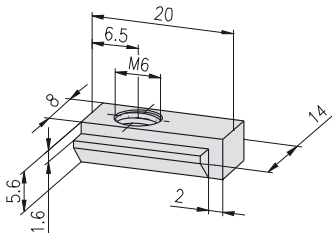

Description	G	$M_{A, max}$	Weight	Article-No.
Anti-twist device F	M6	10 Nm	7.3 g	1.29.321.FM6

Description	G	$M_{A, max}$	Weight	Article-No.
Anti-twist device E	M6	10 Nm	14 g	1.29.321.EM6

Anti-twist devices for subsequent insertion



Application

In the case of high torque forces with connections of one connector only, twisting can be prevented by mounting 1 or 2 anti-twist devices.

- for subsequent insertion

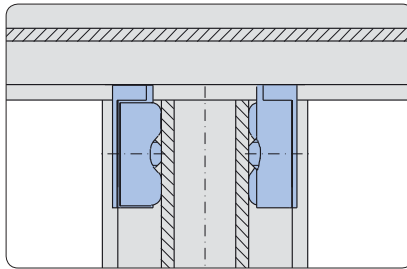

The nose of the anti-twist device fits into the basic profile.

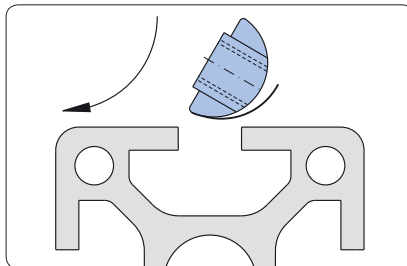
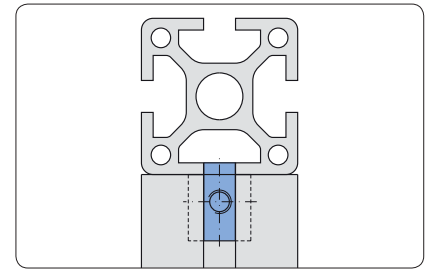

Insert front-sided and rotate

Technical data

material: steel
 surface: galvanised
 max. moment of torque: $M_{A, max}$

Fastening elements

F-slot:
 Setscrew ISO 4026 M6×8 1.20.G0608
 E-slot:
 Setscrew ISO 4026 M6×12 1.20.G0612

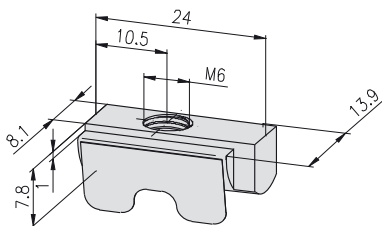
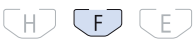
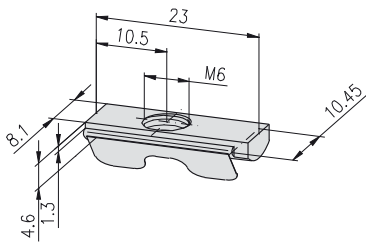

Description	G	$M_{A, max}$	Weight	Article-No.
Anti-twist device F	M6 for subsequent insertion	10 Nm	7.3 g	1.29.324.FM6

Description	G	$M_{A, max}$	Weight	Article-No.
Anti-twist device E	M6 for subsequent insertion	10 Nm	14 g	1.29.324.EM6

Clamping levers

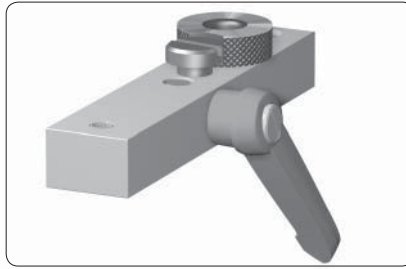

Clamping lever for drill jigs

Application

Any MayTec connector can be equipped with a clamping lever.
For frequent opening and closing



Clamping lever for connector

Technical data

clamping handle: PA-glass-fiber reinf.
clamping lever: with ratchet lever handle
annular gear: die casted zinc
thread: steel

Clamping levers 40
for connector

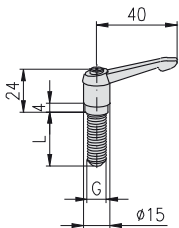

Description	G	L	Weight	Article-No.
Clamping lever 40 for connector	M6	20	17 g	1.29.500620
Clamping lever 40 for connector	M8	20	21 g	1.29.500820
Clamping lever 40 for connector	M10	20	24 g	1.29.501020
Clamping lever 40 for connector	M10	30	29 g	1.29.501030

Clamping levers 65
for connector

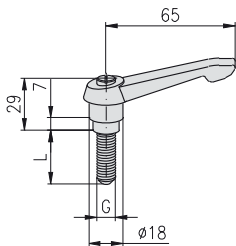





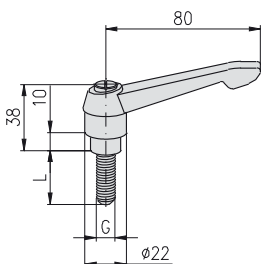





Description	G	L	Weight	Article-No.
Clamping lever 65 for connector	M6	20	36 g	1.29.650620
Clamping lever 65 for connector	M8	20	41 g	1.29.650820
Clamping lever 65 for connector	M8	30	43 g	1.29.650830
Clamping lever 65 for connector	M10	20	44 g	1.29.651020
Clamping lever 65 for connector	M10	30	49 g	1.29.651030

Clamping levers 80
for connector























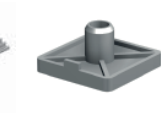





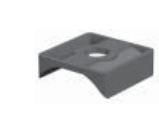



















Description	G	L	Weight	Article-No.
Clamping lever 80 for connector	M8	20	64 g	1.29.800820
Clamping lever 80 for connector	M10	20	65 g	1.29.801020
Clamping lever 80 for connector	M10	30	70 g	1.29.801030







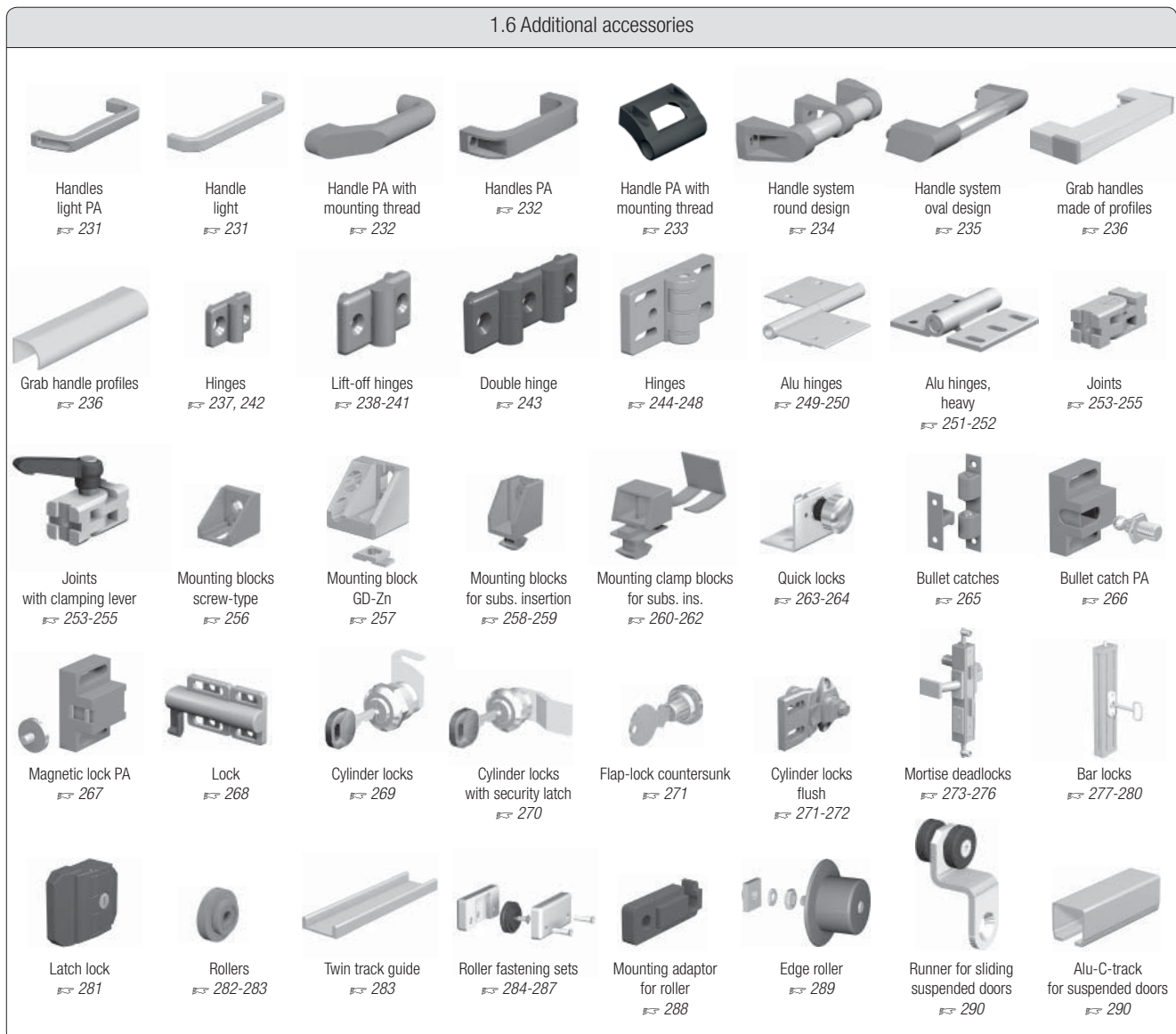
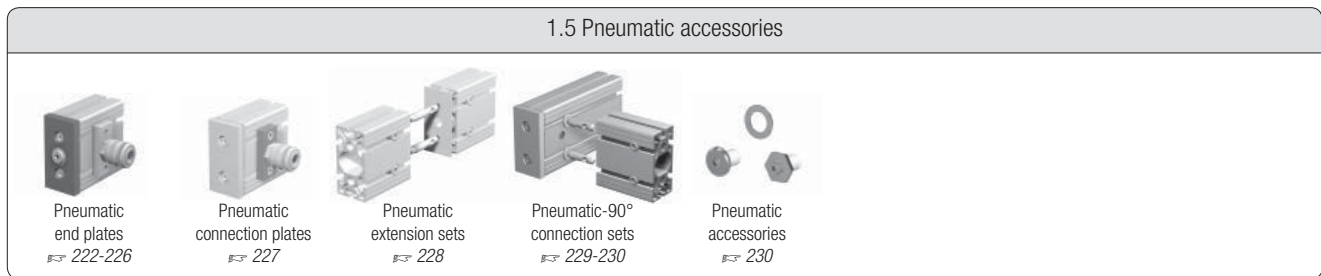
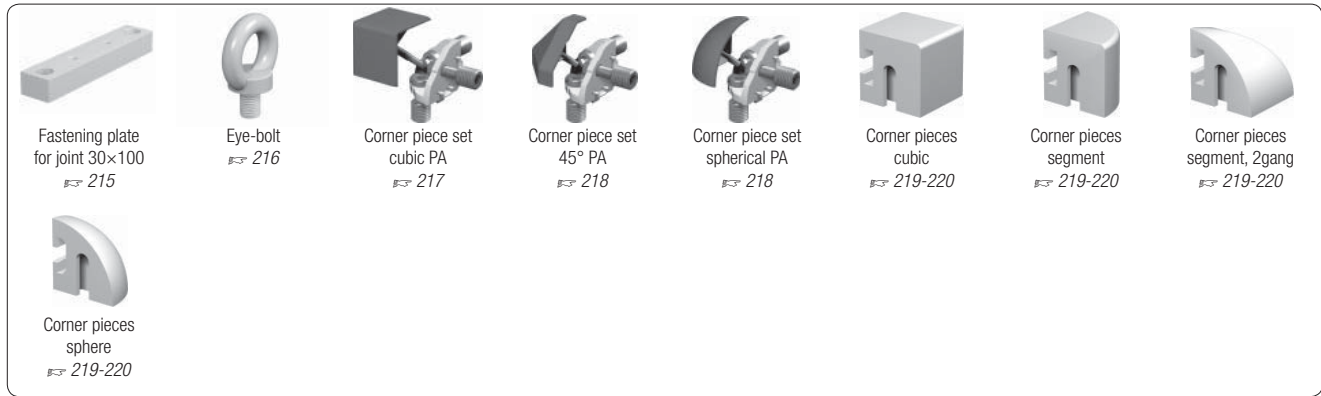

1.3 Fastening elements

							
Threaded plates ➔ 138	Threaded plates for subs. insertion ➔ 139	Threaded plates heavy ➔ 140	T-Nuts ➔ 141	T-Nuts for subs. insertion ➔ 142-144	Spring-nuts front-sided insertion ➔ 145	T-slot nuts ➔ 146	Rhomboid T-slot nuts with self-locking ➔ 147
							
T-Bolts front-sided insertion ➔ 148	Threaded inserts ➔ 149-150	Press-fit threaded inserts ➔ 151-152					











1.4 Installation accessories

							
Cover profiles ➔ 153	Cover profiles ➔ 153	Reducing profiles ➔ 154	Combination profiles ➔ 155	Combination profiles ➔ 156	Combination profiles for sliding profiles ➔ 158	Guide profile for sliding profile ➔ 159	Framing profiles one piece ➔ 160
							
Wedge profiles ➔ 161	Sponge rubber round cords ➔ 162-163	Sealing profile ➔ 164	Framing profiles ➔ 165-167	Rubber cover-profiles ➔ 168	Cover caps for profiles ➔ 169-172	Cover cap Ø48 for hand rail profile ➔ 172	Cover plugs for cross bushings ➔ 173
							
Cover plugs domed for cross bushings ➔ 173	Cover caps for tubes ➔ 174	Cover caps for screw bores ➔ 174	Radius covers ➔ 175-176	Radius compensations ➔ 177	Floor levelling screws ➔ 178	Levelling foot PA 20 ➔ 178	Hand adjustable feet ➔ 179
							
Levelling feet ➔ 180	Adjustable tilt-feet ➔ 181-185	Angular adjusting feet ➔ 186	Base foot ➔ 187	Base feet ➔ 188-192	Base angle ➔ 193	Stacking foot ➔ 193	Fixed castors ➔ 194
							
Swivel castors ➔ 195	Swivel castors lockable ➔ 195	Locking castors ➔ 196-197	Angles ➔ 198	Angles PA ➔ 199	Angles GD-Zn ➔ 200-205	Angles GD-Al ➔ 206	Angles Alu ➔ 207
							
Swivel angles straight design ➔ 208	Swivel angles ➔ 208-209	Cross connection plates ➔ 209	Base plates ➔ 210-211	Floor mounting plate ➔ 212	Mounting plates ➔ 213	Floor plate ➔ 213	Connection plates ➔ 214







							
Frame guide for suspended doors ↔ 291	Rubber door stop for suspended doors ↔ 291	Slot rollers ↔ 292	Sliding blocks ↔ 294	T-Nut sliding blocks ↔ 295	Eco-Slides ↔ 296-299	Hanging bracket ↔ 300	Suspended glider ↔ 301









1.7 Electrical accessories

							
Potential equalisation ↔ 302	Ground connections ↔ 303	Cable and hose clamp ↔ 304	Block for cable binder ↔ 305	Installation rings ↔ 306	Mounting set for 19" profile ↔ 307	Safety switches ↔ 308-309	Safety interlocking-mountings ↔ 310-314
							
Sensor brackets ↔ 315	Electrical installation trunkings ↔ 316-319						

1.8 Panel elements

				
Corner elements for wire net m. profile ↔ 320	Corner element 33 for wire net m. prof. 33x10 ↔ 321	Mounting sockets ↔ 322	Panel elements ↔ 323-326	Wire nets, grid ↔ 326-327

1.9 Tools

							
Self locking washers ↔ 328-329	Button head screws ↔ 330	Press in device for knurled cross bushing ↔ 330	Tx screw driver ↔ 330	Drill jigs ↔ 332, 334	Drills ↔ 333, 335-336	Milling cutters ↔ 333, 335-336	Screw taps ↔ 337-338

Threaded plates

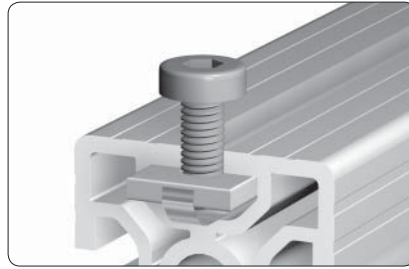

Fixed into position with leaf spring

Application

Fastening element for screw-type connections

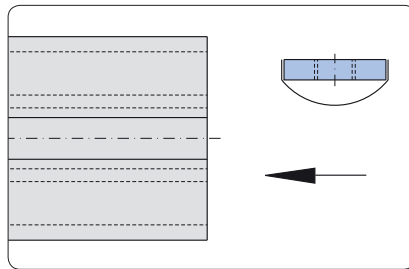

Assembly

Insert from end

Technical data

material: steel
 surface: galvanised
 max. moment of torque: $M_{A, max}$

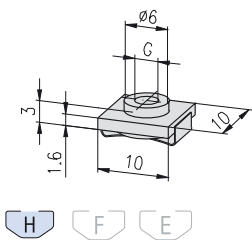

Description	G	$M_{A, max}$	Weight	Article-No.
Threaded plate H	M3	1.3 Nm	1.5 g	1.31.HM3
Threaded plate H	M4	2.0 Nm	1.3 g	1.31.HM4
Threaded plate H	M5	2.0 Nm	1.2 g	1.31.HM5

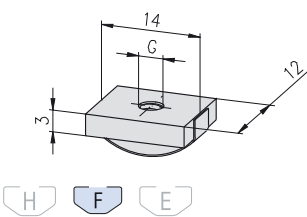

Description	G	$M_{A, max}$	Weight	Article-No.
Threaded plate F	M3	1.3 Nm	3.9 g	1.31.FM3
Threaded plate F	M4	3.0 Nm	3.7 g	1.31.FM4
Threaded plate F	M5	5.0 Nm	3.6 g	1.31.FM5
Threaded plate F	M6	7.0 Nm	3.3 g	1.31.FM6

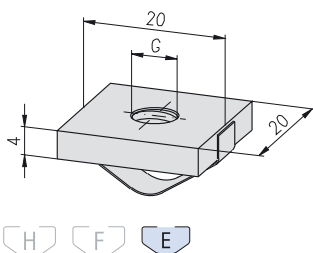

Description	G	$M_{A, max}$	Weight	Article-No.
Threaded plate E	M3	1.3 Nm	12.0 g	1.31.EM3
Threaded plate E	M4	3.0 Nm	11.8 g	1.31.EM4
Threaded plate E	M5	5.0 Nm	11.6 g	1.31.EM5
Threaded plate E	M6	8.0 Nm	11.3 g	1.31.EM6
Threaded plate E	M8	15.0 Nm	11.0 g	1.31.EM8

**Threaded plates
for subsequent insertion**

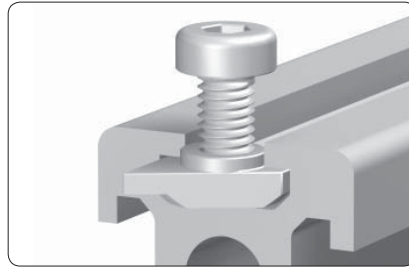

Application

Fastening element for screw-type connections

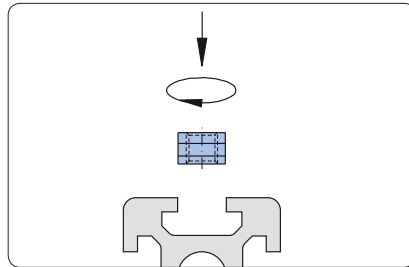

Assembly

Insert frontally and turn 60°

Technical data

material: steel
 surface: galvanised
 max. moment of torque: $M_{A, max}$

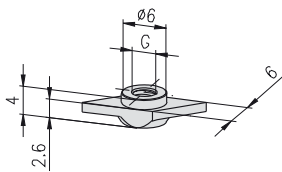

Description

Description	G	$M_{A, max}$	Weight	Article-No.
Threaded plate for subsequent insertion H	M3	1.3 Nm	0.90 g	1.31.4HM3
Threaded plate for subsequent insertion H	M4	2.0 Nm	0.85 g	1.31.4HM4
Threaded plate for subsequent insertion H	M5	2.0 Nm	0.80 g	1.31.4HM5

Threaded plates
heavy

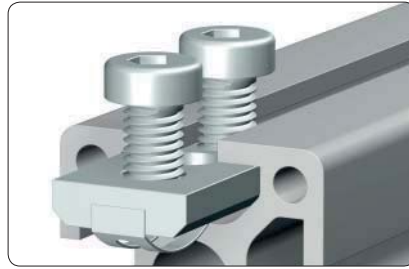

Fixed into position with leaf spring

Application

- Fastening element for
- screw-type connections
 - hinges, heavy, type 20, 21, 22, 23, 31

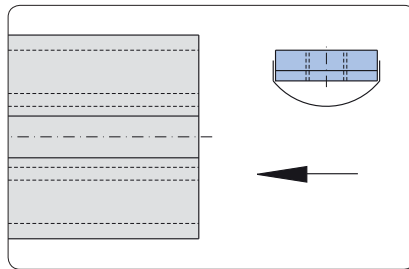

Assembly

Insert from end

Technical data

material: steel
 surface: galvanised
 max. moment of torque: $M_{A, \max}$

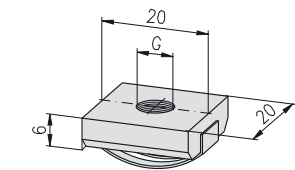

Description	G	$M_{A, \max}$	Weight	Article-No.
Threaded plate, heavy E	M6	10.0 Nm	17.2 g	1.31.6EM6
Threaded plate, heavy E	M8	26.0 Nm	16.3 g	1.31.6EM8

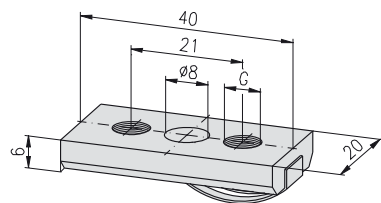

Description	G	$M_{A, \max}$	Weight	Article-No.
Threaded plate, heavy E	2×M6	10.0 Nm	33.8 g	1.31.6E2M6
Threaded plate, heavy E	2×M8	26.0 Nm	32.0 g	1.31.6E2M8

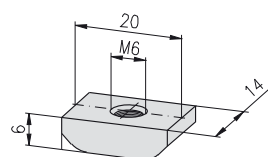

Application

Fastening element for ST-Connector
 with anchor, screw-type ↗ 1.2D
 Application sample ↗ Eco-Slide 1.67

Description	G	$M_{A, \max}$	Weight	Article-No.
Threaded plate, heavy E	M6	10.0 Nm	12.4 g	1.31.7EM6

T-Nuts with spring

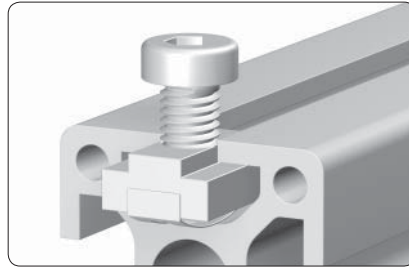

Fixing with leaf spring

Application

Fastening element for screw-type connections

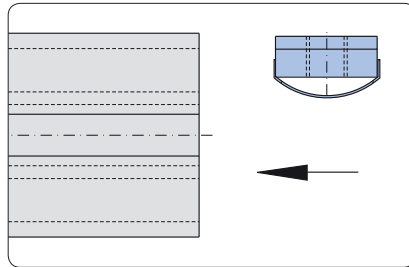

Assembly

Insert from end

Technical data

material: steel
 surface: galvanised
 max. moment of torque: $M_{A, max}$

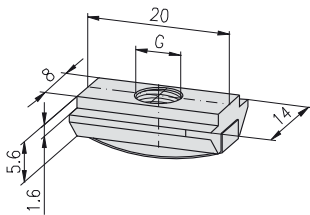

Description	G	$M_{A, max}$	Weight	Article-No.
T-Nut with spring F M6	M6	10 Nm	7.0 g	1.32.FM6
T-Nut with spring F M8	M8	26 Nm	6.6 g	1.32.FM8

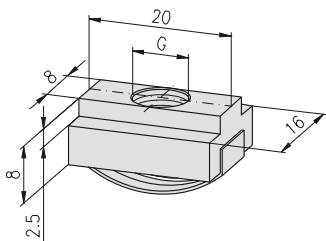

Description	G	$M_{A, max}$	Weight	Article-No.
T-Nut with spring E M6	M6	10 Nm	15 g	1.32.EM6
T-Nut with spring E M8	M8	26 Nm	14 g	1.32.EM8

**T-Nuts
for subsequent insertion,
with spring ball**

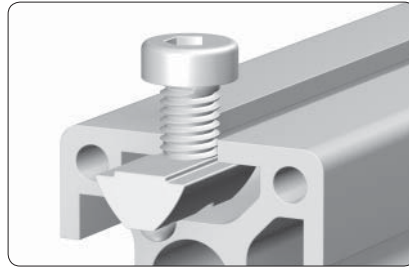

Fixing with spring ball

Application

Fastening element for screw-type connections

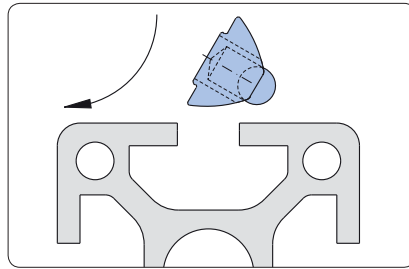

Assembly

Insert front-sided and rotate

Technical data

material: steel
 surface: galvanised
 max. moment of torque: $M_{A, \max}$

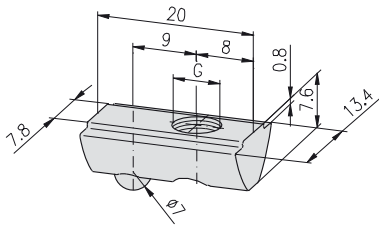

Description

Description	G	$M_{A, \max}$	Weight	Article-No.
T-Nut for subs. insertion, w. spring ball E	M4	3.0 Nm	10.4 g	1.32.3EM4
T-Nut for subs. insertion, w. spring ball E	M5	5.0 Nm	10.2 g	1.32.3EM5
T-Nut for subs. insertion, w. spring ball E	M6	10.0 Nm	9.9 g	1.32.3EM6
T-Nut for subs. insertion, w. spring ball E	M8	26.0 Nm	9.6 g	1.32.3EM8

T-Nuts for subsequent insertion, with spring

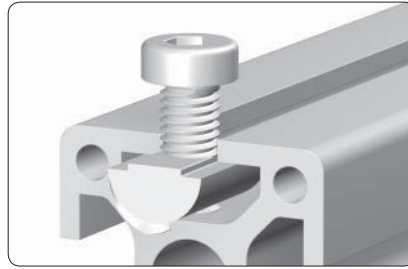

Fixing with leaf spring

Application

Fastening element for screw-type connections

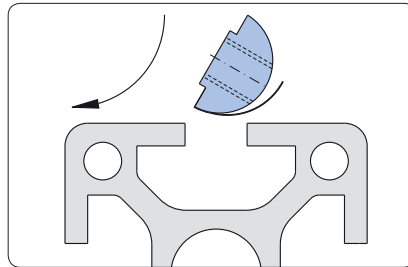

Insert front-sided and rotate

Technical data

Design steel:

- material: steel
- surface: galvanised

Design stainless:

- material: stainless steel 1.4305
- surface: pickled and passivated

max. moment of torque: $M_{A, max}$

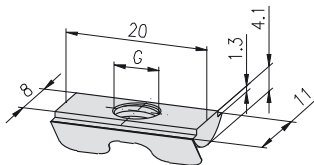

Description	G	Design	$M_{A, max}$	Weight	Article-No.
T-Nut for subs. ins., w. spring F	M3	steel	1.3 Nm	5.0 g	1.32.4FM3
T-Nut for subs. ins., w. spring F	M4	steel	3.0 Nm	4.9 g	1.32.4FM4
T-Nut for subs. ins., w. spring F	M5	steel	5.0 Nm	4.6 g	1.32.4FM5
T-Nut for subs. ins., w. spring F	M6	steel	10.0 Nm	4.3 g	1.32.4FM6
T-Nut for subs. ins., w. spring F	M8	steel	10.0 Nm	3.7 g	1.32.4FM8
T-Nut for subs. ins., w. spring F	M6	stainless	10.0 Nm	4.3 g	1.32.4FM6V
T-Nut for subs. ins., w. spring F	M8	stainless	10.0 Nm	3.7 g	1.32.4FM8V

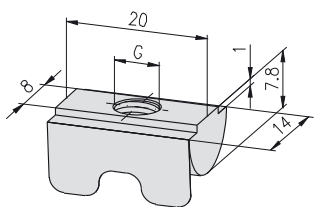

Description	G	Design	$M_{A, max}$	Weight	Article-No.
T-Nut for subs. ins., w. spring E	M3	steel	1.3 Nm	10.0 g	1.32.4EM3
T-Nut for subs. ins., w. spring E	M4	steel	3.0 Nm	10.0 g	1.32.4EM4
T-Nut for subs. ins., w. spring E	M5	steel	5.0 Nm	10.0 g	1.32.4EM5
T-Nut for subs. ins., w. spring E	M6	steel	10.0 Nm	10.0 g	1.32.4EM6
T-Nut for subs. ins., w. spring E	M8	steel	26.0 Nm	9.0 g	1.32.4EM8
T-Nut for subs. ins., w. spring E	M4	stainless	3.0 Nm	10.0 g	1.32.4EM4V
T-Nut for subs. ins., w. spring E	M5	stainless	5.0 Nm	10.0 g	1.32.4EM5V
T-Nut for subs. ins., w. spring E	M6	stainless	10.0 Nm	10.0 g	1.32.4EM6V
T-Nut for subs. ins., w. spring E	M8	stainless	26.0 Nm	9.0 g	1.32.4EM8V

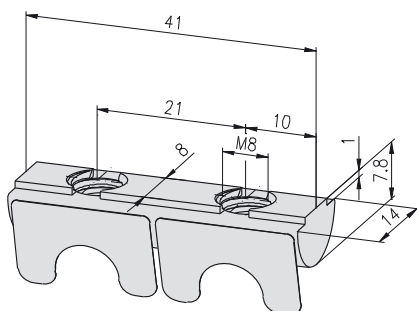

Fixing with leaf spring

Application

- Fastening element for
- screw-type connections
 - hinges, heavy, type 20, 21, 31

Technical data

material: steel
 surface: galvanised
 max. moment of torque: $M_{A, max}$

Description	G	$M_{A, max}$	Weight	Article-No.
T-Nut for subs. ins., w. spring E	2×M8	26.0 Nm	20.3 g	1.32.4E2M8.41

T-Nuts for subsequent insertion, with spring

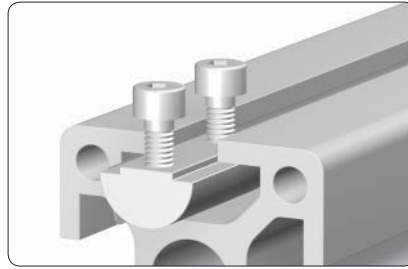

Fixing with leaf spring

Application

Fastening element for screw-type connections

Technical data

material: steel
 surface: galvanised
 max. moment of torque: $M_{A, \max}$

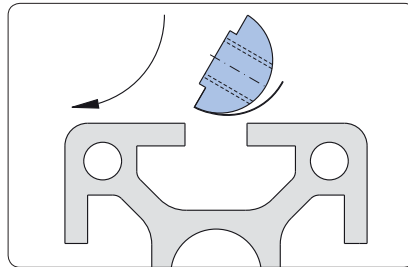

Assembly

Insert front-sided and rotate

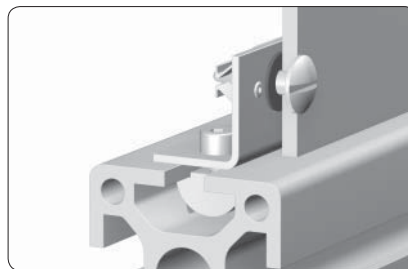

Application

Fastening element for mounting angle, quick lock \rightarrow 265

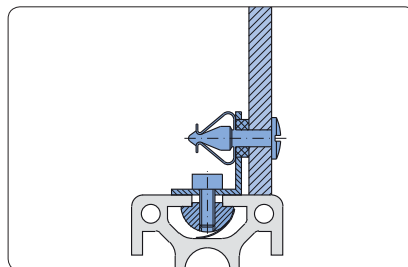

Fastening without washer

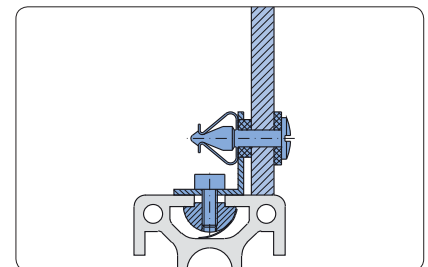

Fastening with washer

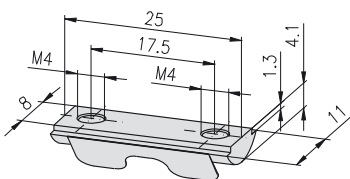

Description	G	$M_{A, \max}$	Weight	Article-No.
T-Nut for subs. ins., w. spring F	2×M4	3.0 Nm	7.0 g	1.32.4F2M4.25

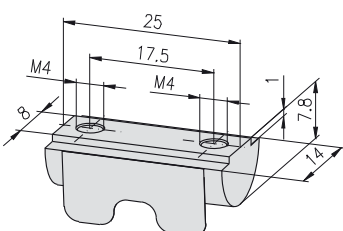

Description	G	$M_{A, \max}$	Weight	Article-No.
T-Nut for subs. ins., w. spring E	2×M4	3.0 Nm	12.0 g	1.32.4E2M4.25

Spring-nuts
front-sided insertion

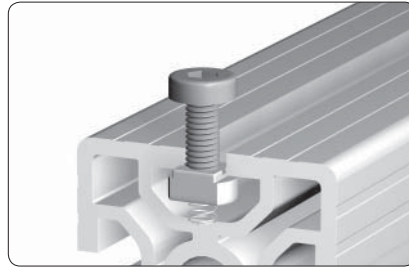

Fixing with compressing spring

Application

Fastening element for screw-type connections
Applicable for small loads such as:

- enclosures
- electric switches

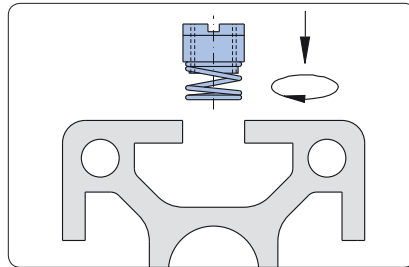

Assembly

Insert front-sided and turn 90°

Technical data

material: steel
surface: galvanised
max. moment of torque: $M_{A, max}$

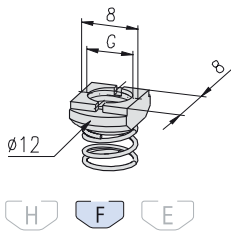

Description	G	$M_{A, max}$	Weight	Article-No.
Spring-nut F	M3	1.3 Nm	1.6 g	1.33.FM3
Spring-nut F	M4	3.0 Nm	1.5 g	1.33.FM4
Spring-nut F	M5	5.0 Nm	1.3 g	1.33.FM5
Spring-nut F	M6	8.0 Nm	1.1 g	1.33.FM6

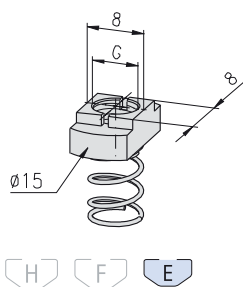

Description	G	$M_{A, max}$	Weight	Article-No.
Spring-nut E	M3	1.3 Nm	3.9 g	1.33.EM3
Spring-nut E	M4	3.0 Nm	3.7 g	1.33.EM4
Spring-nut E	M5	5.0 Nm	3.4 g	1.33.EM5
Spring-nut E	M6	10.0 Nm	3.0 g	1.33.EM6

T-slot nuts

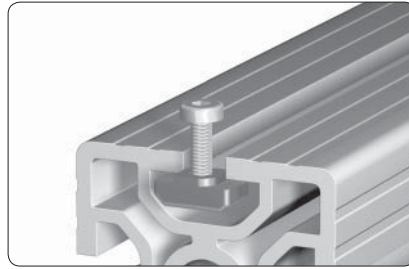

Application

Fastening element for screw-type connections

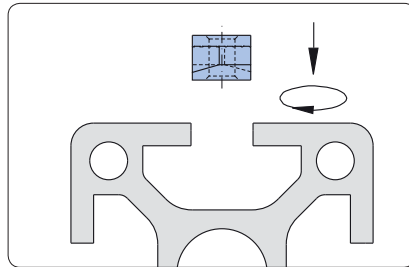

Assembly

Mount the T-slot nut onto the screw and insert into the slot

Rotate the screw with T-slot nut 90° inside and then fasten

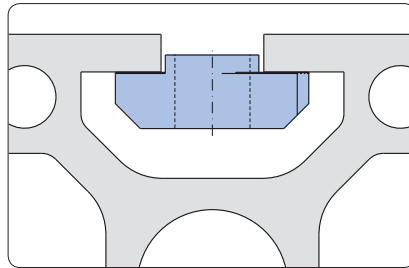

Technical data

material: GD-Zn
 surface: galvanised
 max. moment of torque: $M_{A, max}$

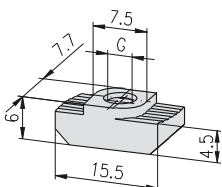
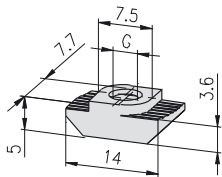

Description	G	$M_{A, max}$	Weight	Article-No.
T-slot nut F	M4	3.0 Nm	2.4 g	1.34.10FM4
T-slot nut F	M5	5.0 Nm	2.0 g	1.34.10FM5
T-slot nut F	M6	10.0 Nm	1.7 g	1.34.10FM6

Description	G	$M_{A, max}$	Weight	Article-No.
T-slot nut E	M4	3.0 Nm	3.6 g	1.34.10EM4
T-slot nut E	M5	5.0 Nm	3.2 g	1.34.10EM5
T-slot nut E	M6	10.0 Nm	3.0 g	1.34.10EM6

Rhomboid T-slot nuts with self-locking

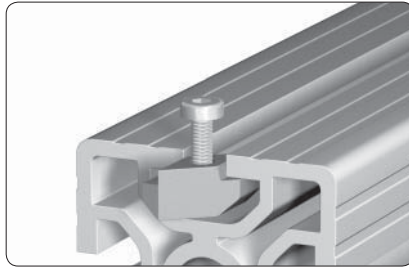

Application

For pre-assembly of threads in the profile slot

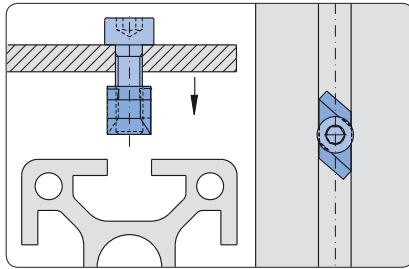

Assembly

Pre-assemble the rhomboid T-slot nut onto the screw, and insert into the slot

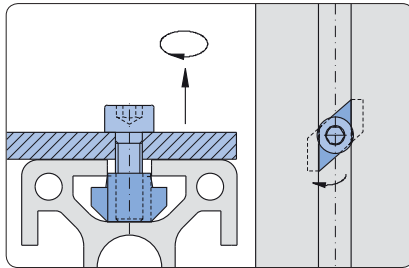

By tightening the screw, the rhomboid T-slot nut is turned 90° and jammed inside the slot with its conical flanks

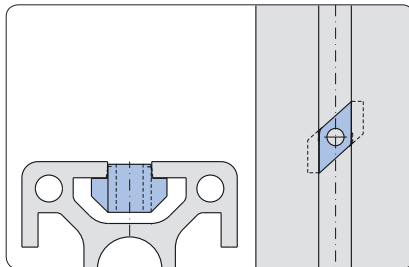

Even after loosening the screw, the rhomboid T-slot nut will remain wedged in place

Technical data

material: GD-Zn
 surface: galvanised
 max. moment of torque: $M_{A, max}$

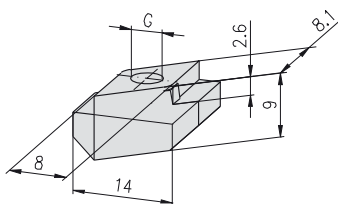

Description	G	$M_{A, max}$	Weight	Article-No.
Rhomboid T-slot nut E	M3	1.3 Nm	6.5 g	1.34.20EM3
Rhomboid T-slot nut E	M4	3.0 Nm	6.2 g	1.34.20EM4
Rhomboid T-slot nut E	M5	5.0 Nm	5.9 g	1.34.20EM5
Rhomboid T-slot nut E	M6	10.0 Nm	5.5 g	1.34.20EM6

**T-Bolts
front-sided insertion**

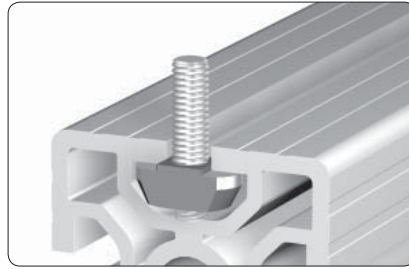

Fixing with compressing spring

Application

Fastening element for screw-type connections

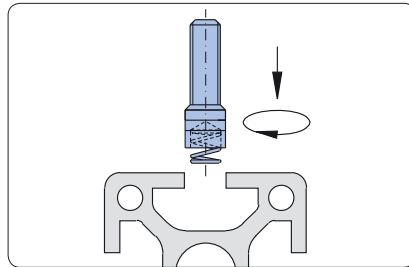

Assembly

Insert front-sided and turn 90°

Technical data

material: steel
 surface: galvanised
 max. moment of torque: $M_{A, \max}$

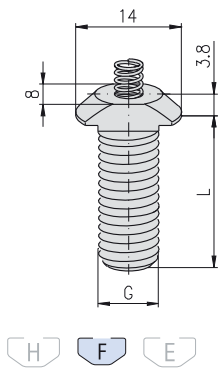

Description	G×L	$M_{A, \max}$	Weight	Article-No.
T-Bolt F	M6×20	6 Nm	6.0 g	1.34.FM62
T-Bolt F	M6×30	6 Nm	7.0 g	1.34.FM63
T-Bolt F	M8×20	15 Nm	8.0 g	1.34.FM82
T-Bolt F	M8×30	15 Nm	11.2 g	1.34.FM83

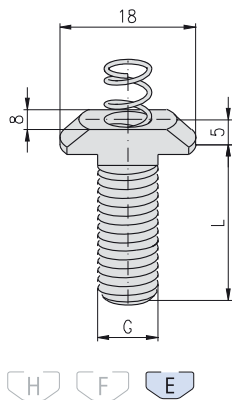

Description	G×L	$M_{A, \max}$	Weight	Article-No.
T-Bolt E	M6×20	6 Nm	9.0 g	1.34.EM62
T-Bolt E	M6×30	6 Nm	10.0 g	1.34.EM63
T-Bolt E	M8×20	18 Nm	12.0 g	1.34.EM82
T-Bolt E	M8×25	18 Nm	13.0 g	1.34.EM825
T-Bolt E	M8×30	18 Nm	14.0 g	1.34.EM83
T-Bolt E	M8×40	18 Nm	18.0 g	1.34.EM84

Threaded inserts

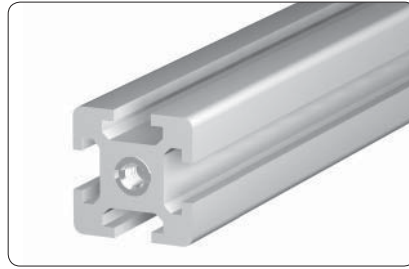

Application
For mounting on front end

Technical data

material: steel
surface: galvanised

Comments
for core hole Ø6

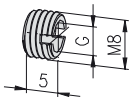

Description	G	Weight	Article-No.
Threaded insert	M8/M4	1.0 g	1.35.10804
Threaded insert	M8/M5	0.9 g	1.35.10805

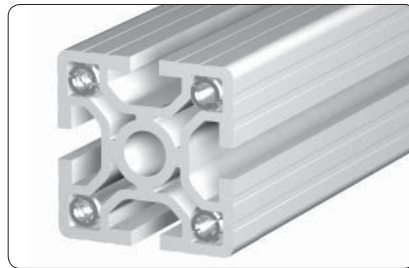

Application
For mounting on front end

Technical data

material: steel
surface: galvanised

Comments
for outer chambers PG 50, heavy

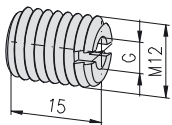

Description	G	Weight	Article-No.
Threaded insert	M12/M4	8.6 g	1.35.11204
Threaded insert	M12/M5	8.0 g	1.35.11205
Threaded insert	M12/M6	7.3 g	1.35.11206
Threaded insert	M12/M8	5.5 g	1.35.11208

Threaded inserts

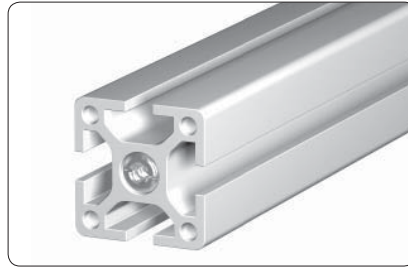

Application

For mounting on front end and fastening of any profile with core hole Ø12

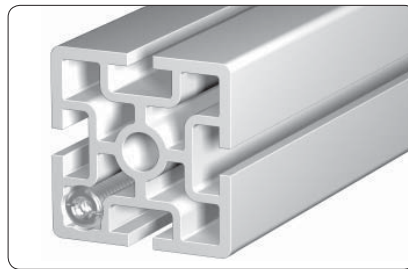

Application

For mounting on front end and fastening of profiles PG 60

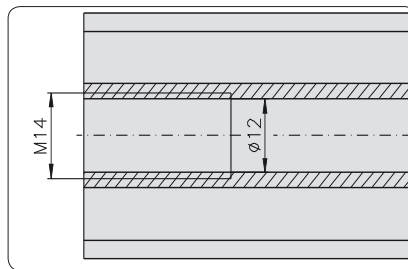

Assembly preparation for threaded insert M14/Mxx

- Tap M14 thread in core hole Ø12 mm

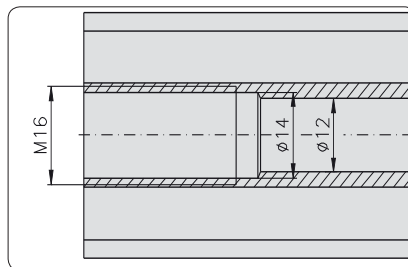

1) Assembly preparation for threaded insert M16/M12

- Drill Ø12 mm core hole to 14 mm
- Tap M16 thread in core hole Ø14 mm

Technical data

material: steel
surface: galvanised

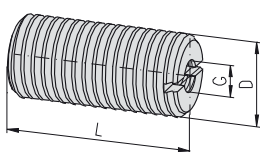

Description	D/G	L	Weight	Article-No.
Threaded insert	M14/M6	15	11 g	1.35.1140615
Threaded insert	M14/M6	30	22 g	1.35.1140630
Threaded insert	M14/M8	15	9 g	1.35.1140815
Threaded insert	M14/M8	30	18 g	1.35.1140830
Threaded insert	M14/M10	15	6 g	1.35.1141015
Threaded insert	M14/M10	30	12 g	1.35.1141030
1) Threaded insert	M16/M12	15	8 g	1.35.1161215
1) Threaded insert	M16/M12	30	16 g	1.35.1161230

Press-fit threaded inserts

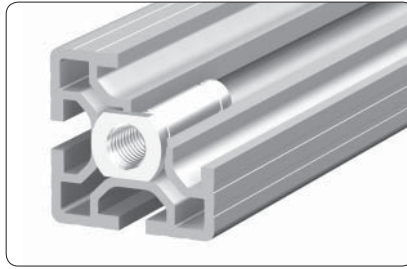

Application

For mounting on front end and fastening of any profile with core hole Ø12

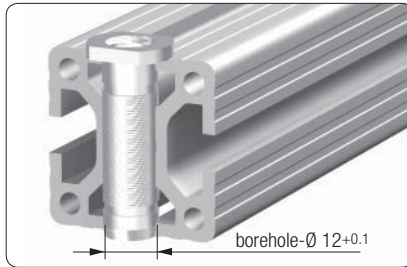

Application

For screw connections across the profile for cross section of 20 mm / 30 mm / 40 mm / 45 mm / 50 mm

Technical data

material: steel
surface: galvanised

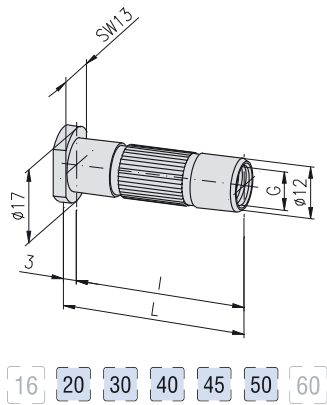

Description	G	L	I	Weight	Article-No.
Press-fit threaded insert	Ø12/M8	22.5	19.5	15 g	1.35.608195
Press-fit threaded insert	Ø12/M8	32.5	29.5	20 g	1.35.608295
Press-fit threaded insert	Ø12/M8	42.5	39.5	26 g	1.35.608395
Press-fit threaded insert	Ø12/M8	47.5	44.5	28 g	1.35.608445
Press-fit threaded insert	Ø12/M8	52.5	49.5	31 g	1.35.608495
Press-fit threaded insert	Ø12/M10	22.5	19.5	11 g	1.35.610195
Press-fit threaded insert	Ø12/M10	32.5	29.5	15 g	1.35.610295
Press-fit threaded insert	Ø12/M10	42.5	39.5	18 g	1.35.610395
Press-fit threaded insert	Ø12/M10	47.5	43.5	20 g	1.35.610445
Press-fit threaded insert	Ø12/M10	52.5	49.5	22 g	1.35.610495

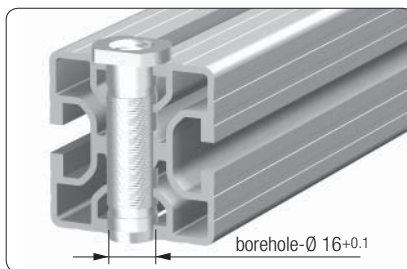

Application

For screw connections across the profile for cross section of 30 mm / 40 mm / 45 mm / 50 mm

Technical data

material: steel
surface: galvanised

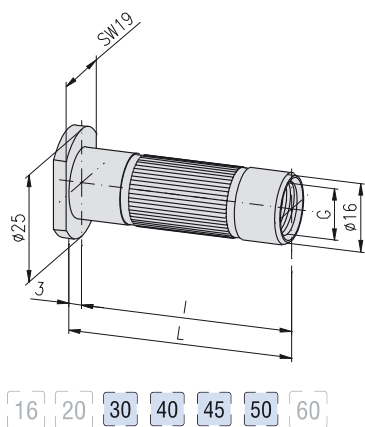

Description	G	L	I	Weight	Article-No.
Press-fit threaded insert	Ø16/M14	32.5	29.5	25 g	1.35.614295
Press-fit threaded insert	Ø16/M14	42.5	39.5	30 g	1.35.614395
Press-fit threaded insert	Ø16/M14	47.5	44.5	32 g	1.35.614445
Press-fit threaded insert	Ø16/M14	52.5	49.5	35 g	1.35.614495

**Press-fit threaded inserts
w/o collar**

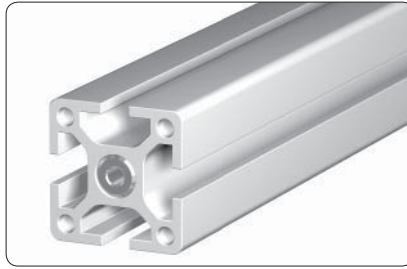

Application

For mounting on front end and fastening of any profile with core hole $\varnothing 12$

Technical data

material: steel
surface: galvanised

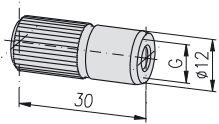

- 16
- 20
- 30
- 40
- 45
- 50
- 60

Description	G	Weight	Article-No.
Press-fit threaded insert, w/o collar	$\varnothing 12/M6$	19 g	1.35.606300
Press-fit threaded insert, w/o collar	$\varnothing 12/M8$	17 g	1.35.608300

Cover profiles

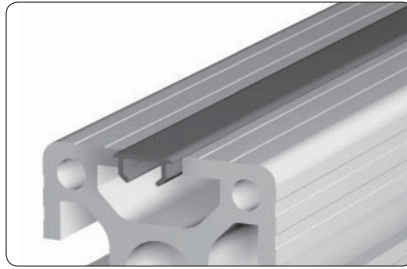

Application

Cover profile with 1.2 mm jutout for the protection of the profile slots

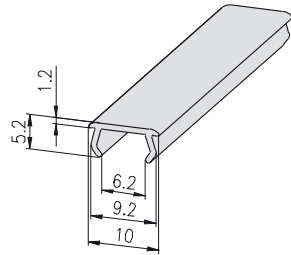

Technical data

- bar length: 2.5 m
- material: PVC rigid
- oil and water resistant
- anti-electrostatic
- lead- and cadmium free

Description	Colour	similar to RAL	Weight	Article-No.
Cover profile 10, PVC, F/E,	grey	7035	85 g/bar	1.41.11.1
Cover profile 10, PVC, F/E,	black	9011	85 g/bar	1.41.11.2
Cover profile 10, PVC, F/E,	yellow	1023	85 g/bar	1.41.11.1023

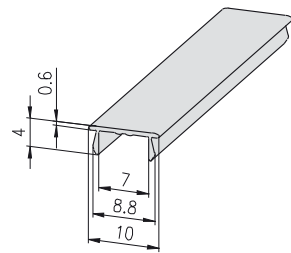

Technical data

- bar length: 2.5 m
- material: aluminium
- surface: natural anodised

Description	Weight	Article-No.
Cover profile 10, Alu, F/E	67.5 g/bar	1.41.121

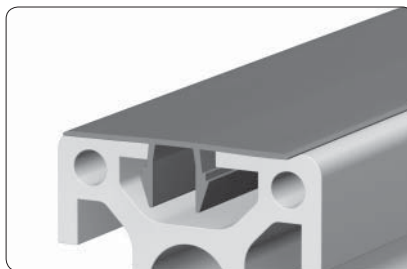

Application

Cover profile for the protection of the profile slots
Dangerous spots can be marked with yellow cover profiles

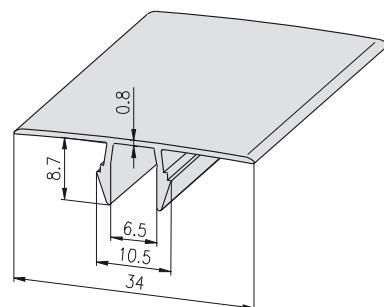

Technical data

- bar length: 2.5 m
- material: PVC rigid
- oil and water resistant

Description	Colour	similar to RAL	bar	Weight	Article-No.
Cover profile 34, PVC, E,	grey	7035	2.5 m	170 g/bar	1.41.15E34.1
Cover profile 34, PVC, E,	black	9011	2.5 m	170 g/bar	1.41.15E34.2
Cover profile 34, PVC, E,	yellow	1003	3.0 m	204 g/bar	1.41.15E34.1003

Reducing profiles PVC

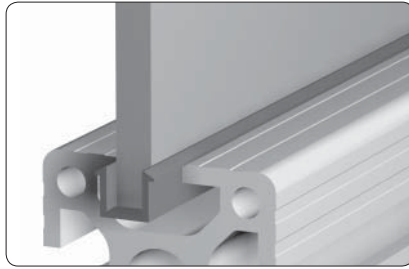

Application

To reduce the slot size from 8 mm to 6 mm

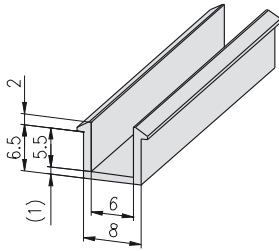

Technical data

bar length: 2.5 m

material: PVC rigid

- oil and water resistant
- anti-electrostatic
- lead- and cadmium free

Description	Colour	similar to RAL	Weight	Article-No.
Reducing profile PVC, F/E, 8/6	grey	7035	85 g/bar	1.41.21.1
Reducing profile PVC, F/E, 8/6	black	9011	85 g/bar	1.41.21.2

Combination profiles PVC

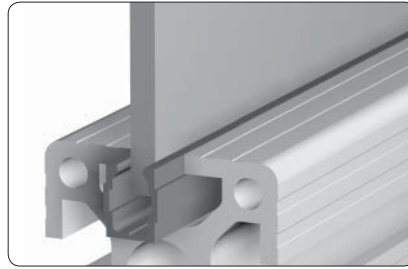

Use as reduction profile

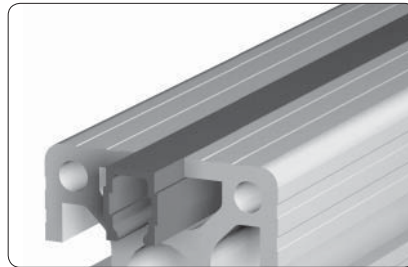

Use as slot-cover profile

Application

Combination profiles for use as reduction or cover profiles

Technical data

bar length: 2.5 m
 material: PVC rigid
 • oil and water resistant

Colours: grey
 black
 red
 blue
 green

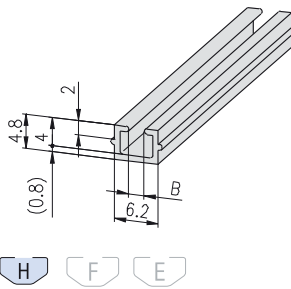

Description	B	Colour	similar to RAL	Weight	Article-No.
Combination profile PVC, H	2	grey	7035	37.5 g/bar	1.41.H02.1
Combination profile PVC, H	2	black	9011	37.5 g/bar	1.41.H02.2
Combination profile PVC, H	2	red	3000	37.5 g/bar	1.41.H02.3000
Combination profile PVC, H	2	blue	5002	37.5 g/bar	1.41.H02.5002
Combination profile PVC, H	2	green	6024	37.5 g/bar	1.41.H02.6024
Combination profile PVC, H	4	grey	7035	35.0 g/bar	1.41.H04.1
Combination profile PVC, H	4	black	9011	35.0 g/bar	1.41.H04.2

Combination profiles

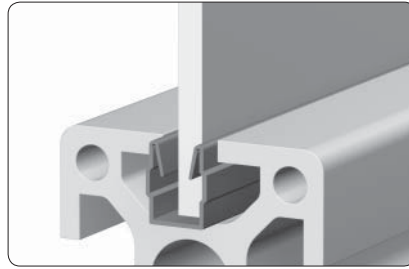

Use as reduction profile

Application

Combination profiles for use as reduction or cover profiles

Technical data

bar length: 2.5 m
material: PP
• oil and water resistant

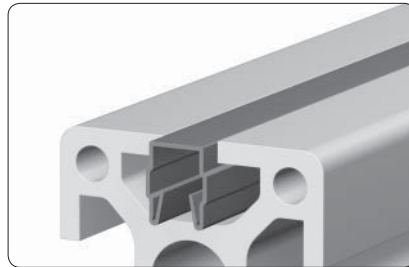

Use as slot-cover profile

Colours: grey
black
orange
red
blue
green

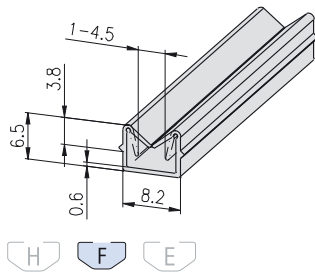

Description	D	Colour	similar to RAL	Weight	Article-No.
Combination profile F	1 - 4.5	grey	7035	31 g/bar	1.41.F14.1
Combination profile F	1 - 4.5	black	9011	31 g/bar	1.41.F14.2

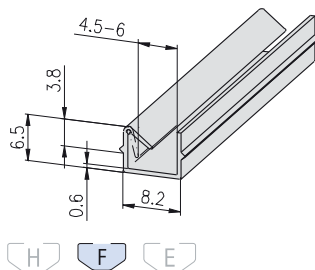

Description	D	Colour	similar to RAL	Weight	Article-No.
Combination profile F	4.5 - 6	grey	7035	28 g/bar	1.41.F46.1
Combination profile F	4.5 - 6	black	9011	28 g/bar	1.41.F46.2
Combination profile F	4.5 - 6	red	3000	28 g/bar	1.41.F46.3000
Combination profile F	4.5 - 6	blue	5002	28 g/bar	1.41.F46.5002
Combination profile F	4.5 - 6	green	6024	28 g/bar	1.41.F46.6024

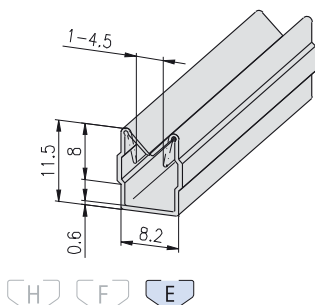

Description	D	Colour	similar to RAL	Weight	Article-No.
Combination profile E	1 - 4.5	grey	7035	47 g/bar	1.41.E314.1
Combination profile E	1 - 4.5	black	9011	47 g/bar	1.41.E314.2

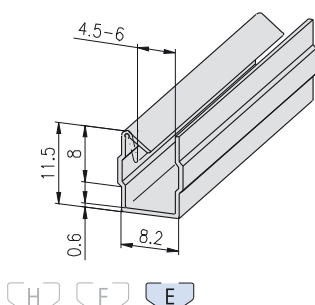

Description	D	Colour	similar to RAL	Weight	Article-No.
Combination profile E	4.5 - 6	grey	7035	42 g/bar	1.41.E346.1
Combination profile E	4.5 - 6	black	9011	42 g/bar	1.41.E346.2
Combination profile E	4.5 - 6	orange	2004	42 g/bar	1.41.E346.2004
Combination profile E	4.5 - 6	red	3000	42 g/bar	1.41.E346.3000
Combination profile E	4.5 - 6	blue	5002	42 g/bar	1.41.E346.5002
Combination profile E	4.5 - 6	green	6024	42 g/bar	1.41.E346.6024

Sliding doors
construction types

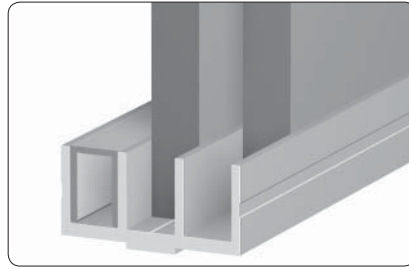

Fixed

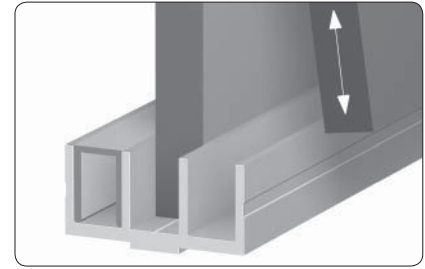

Removable

Profile	Sliding profile 30 mm			Sliding profile 50 mm	
Type of mounting	Fixed	Removable		Fixed	Removable
Profile above	30×14	30×26	30×26	50×14	50×14
Profile below	30×14	30×14	30×26	50×14	50×14
Panel element 8 mm	 $H = A - 6$	 $H = A - 18$ $H1 = A - 44$	 $H = A - 30$ $H1 = A - 56$	 $H = A - 9$	 $H = A - 19$ $H1 = A - 45$
Panel element 6 mm	 $H = A - 8$	 $H = A - 19$ $H1 = A - 45$	 $H = A - 31$ $H1 = A - 57$	 $H = A - 9$	 $H = A - 19$ $H1 = A - 45$
Panel element 1 - 14 mm	 $H = A - 6$ $H1 = A - 58$	 $H = A - 18$ $H1 = A - 70$	 $H = A - 30$ $H1 = A - 82$	 $H = A - 17$ $H1 = A - 69$	 $H = A - 19$ $H1 = A - 71$

Combination profiles PVC

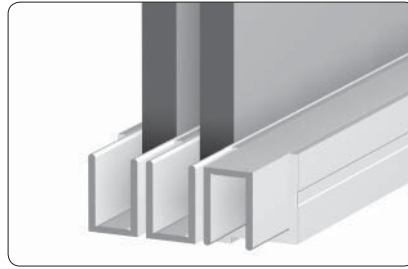

Application

Combination profiles for sliding profiles alternatively suitable as:

- reducing profile
- cover profile
- Inserted plate (only combination profile 1.41.330)

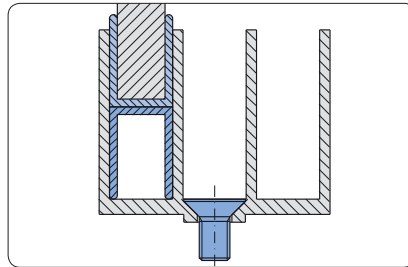

Inserted plate for sliding profile 30×26:
combination profile 1.41.330

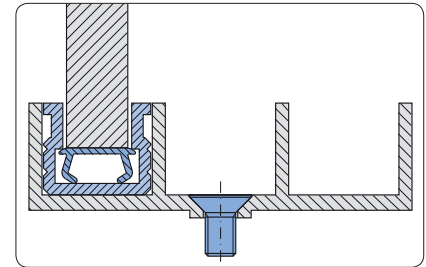

Inserted plate for sliding profile 50×14:
for sliding profile 1.41.11.1, 1.41.11.2

Technical data

bar length: 2.5 m
 material: PVC rigid
 oil and water resistant
 colour: grey

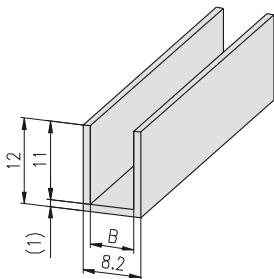

Description	B	Weight	Article-No.
Combination profile PVC for 30×14	6.2	115 g/bar	1.41.330

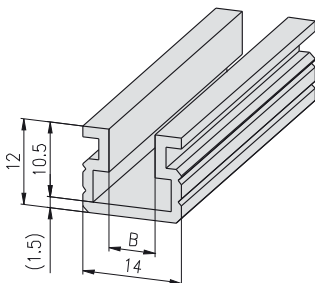

Description	B	Weight	Article-No.
Combination profile PVC for 50×14	6.5	222.5 g/bar	1.41.350
Combination profile PVC for 50×14	9.0	205.0 g/bar	1.41.351

Guide profile PVC

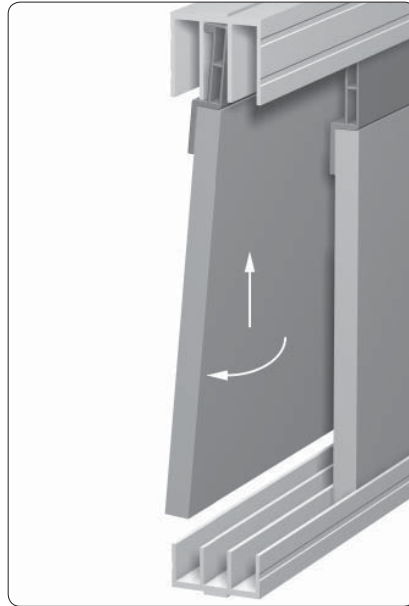

Application

- The guide profile is necessary
- for demountable sliding doors
 - for the use of panel elements of each plate thickness from 1 mm to 14 mm

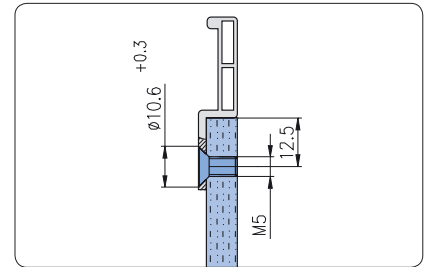

Drill dimensions

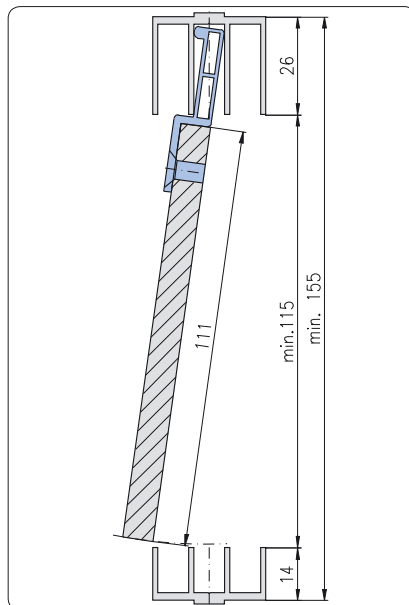

Minimum height for lifting of the panel elements

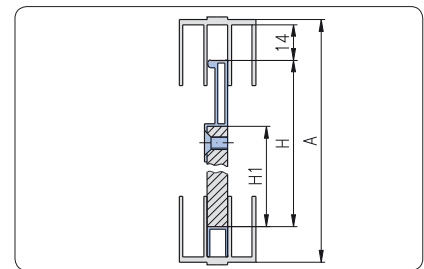

Use in sliding profile 30x26

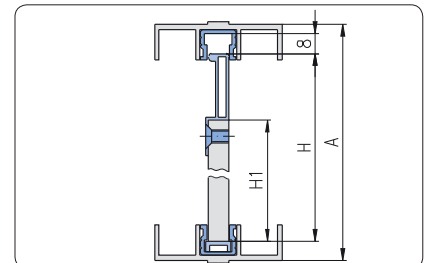

Use in sliding profile 50x14 with combination profile

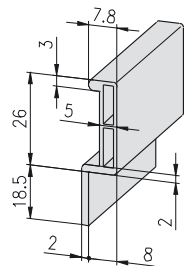

Technical data

- bar length: 2.5 m
 material: PVC rigid
 oil and water resistant
 colour: grey

Description

Guide profile PVC for sliding profile

Weight

375 g/bar

Article-No.

1.41.360

Framing profiles
one piece

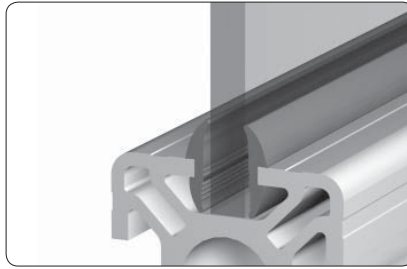

Application

The one piece framing profile for mounting panels of different thickness
The elastic lips provide a good seal

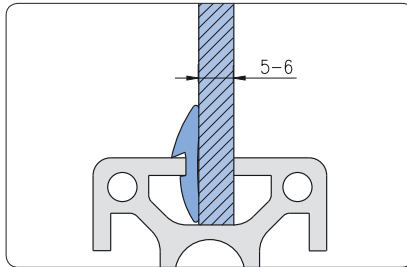

One sided application for profiles with F- and E-slots and panels 5 - 6 mm thick

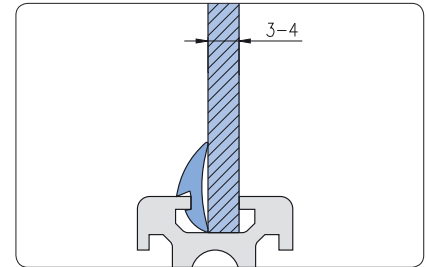

One sided application for profiles with H-slots and panels 3 - 4 mm thick

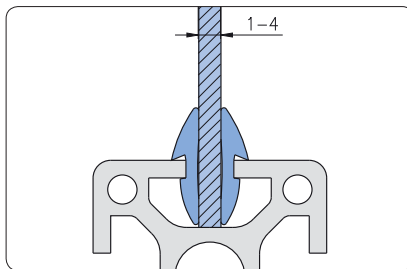

Two sided application for profiles with F- and E-slots and panels 1 - 4 mm thick

Technical data

- length of ring: 60 m
- material: NBR - 60 Shore A
 - compatible with acrylic glass
 - oil and water resistant

Colours

- grey: similar to RAL 7035
- black: similar to RAL 9011

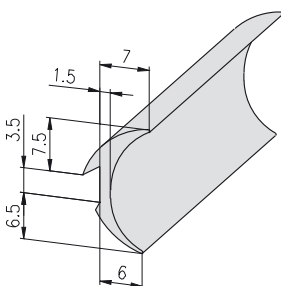
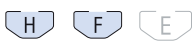
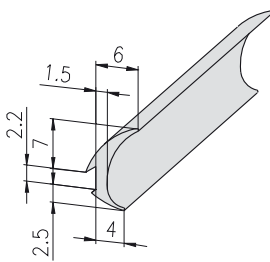

Description	Colour	Weight	Article-No.
Framing profile one piece F	grey ring	2,200 g/ring	1.41.5F0.1.60
Framing profile one piece F	grey cut to length	37 g/m	1.41.5F0.1-A00A00/...
Framing profile one piece F	black ring	2,200 g/ring	1.41.5F0.2.60
Framing profile one piece F	black cut to length	37 g/m	1.41.5F0.2-A00A00/...

/... = length in mm



Description	Colour	Weight	Article-No.
Framing profile one piece E	grey ring	3,120 g/ring	1.41.5E0.1.60
Framing profile one piece E	grey cut to length	52 g/m	1.41.5E0.1-A00A00/...
Framing profile one piece E	black ring	3,120 g/ring	1.41.5E0.2.60
Framing profile one piece E	black cut to length	52 g/m	1.41.5E0.2-A00A00/...

/... = length in mm



Wedge profiles



Application

Wedge profiles for sealing or fixing of panel elements with a thickness of 4 mm

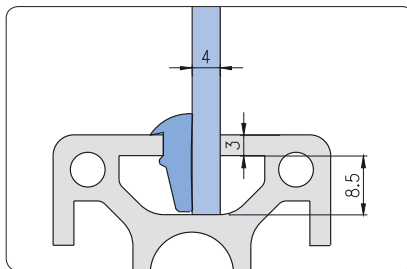
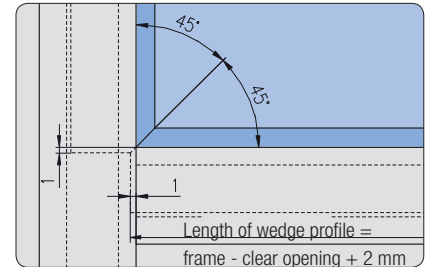
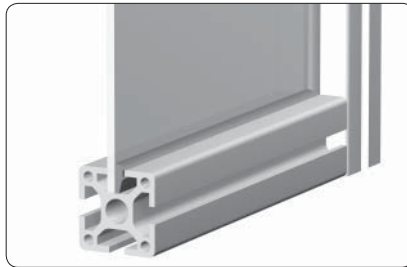

E3-slot

Technical data

- length of ring: 100 m
- material: Santoprene
- free of silicon
- compatible with acrylic glass

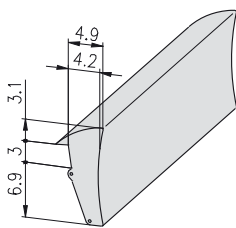

Description	Colour		Weight	Article-No.
Wedge profile E3	grey	ring	5.0 kg/ring	1.41.51E3.1.99
Wedge profile E3	grey	cut to length	50 g/m	1.41.51E3.1-A00A00/... /... = length in mm

Sponge rubber round cords

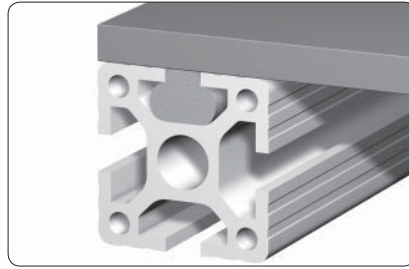

Application

Sponge rubber round cords for sealing

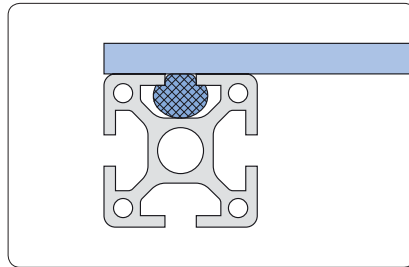

Profile with panel element

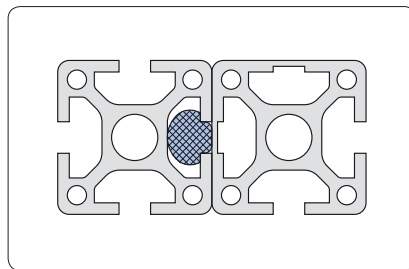

1 profile with slot
1 profile closed

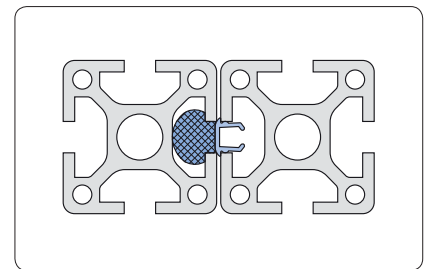

2 profiles with slots
1 profile with slot-cover profile

Sponge rubber round cord diameter-determination	
Profile slot	Sponge rubber diameter
H-slot	8 mm
F-slot	12 mm
E-slot	18 mm

Sponge rubber round cords

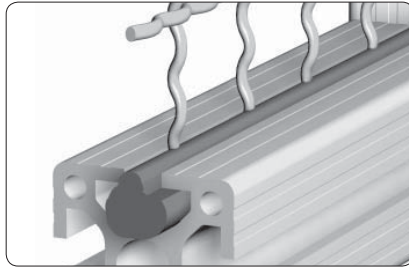

Application

For compensation of slot width on in-between sizes of cover panels

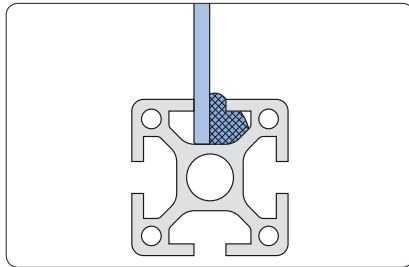

Enclosures with panel materials

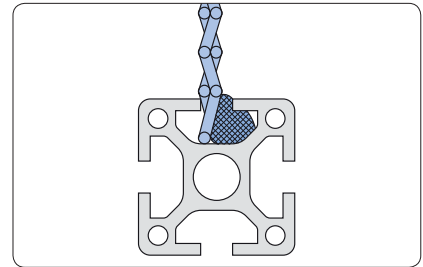

Enclosures with wire screens

Sponge rubber round cord diameter-determination		
Profile slot	Plate thickness	Sponge rubber diameter
H-slot	1 - 3 mm	6 mm
F-slot	1 - 2 mm	10 mm
	3 mm	8 mm
	4 - 5 mm	6 mm
E-slot	1 - 3 mm	10 mm
	3 - 4 mm	2×8 mm
	5 mm	2×6 mm

Technical data

length of ring: 100 m
 material: EPDM
 colour: grey

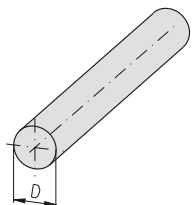

Description	D	Weight	Article-No.
Sponge rubber round cords	Ø6 ring	1.1 kg/ring	1.41.606.99
Sponge rubber round cords	Ø6 cut to length	11 g/m	1.41.606-A00A00/...
Sponge rubber round cords	Ø8 ring	1.9 kg/ring	1.41.608.99
Sponge rubber round cords	Ø8 cut to length	19 g/m	1.41.608-A00A00/...
Sponge rubber round cords	Ø10 ring	3.2 kg/ring	1.41.610.99
Sponge rubber round cords	Ø10 cut to length	32 g/m	1.41.610-A00A00/...
Sponge rubber round cords	Ø12 ring	4.6 kg/ring	1.41.612.99
Sponge rubber round cords	Ø12 cut to length	46 g/m	1.41.612-A00A00/...
Sponge rubber round cords	Ø18 ring	10.0 kg/ring	1.41.618.99
Sponge rubber round cords	Ø18 cut to length	100 g/m	1.41.618-A00A00/...

/... = length in mm

Sealing profile

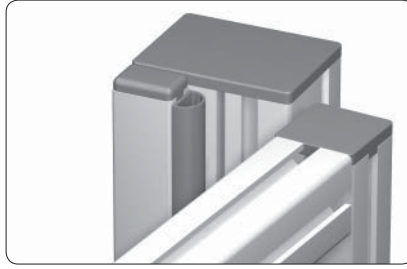

Application

For sealing of doors and windows and for door stops

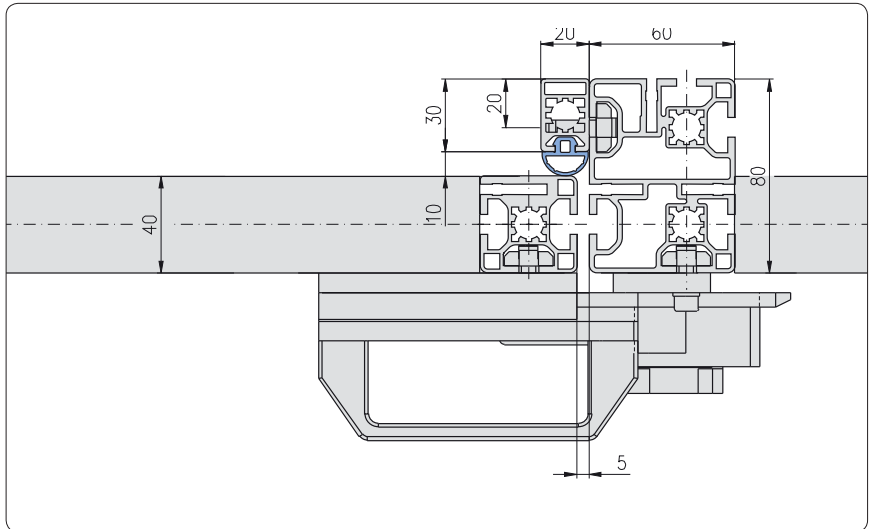

Technical data

length of ring: 40 m

material: EPDM, 60° ± 5° Shore A

- free of silicon
- compatible with acrylic glass

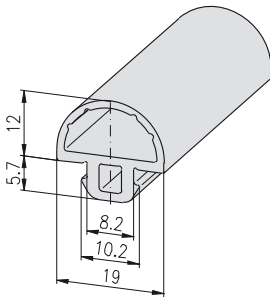

Description	Colour		Weight	Article-No.
Sealing profile F	black	ring	5.12 kg/ring	1.41.6510F.2.40
Sealing profile F	black	cut to length	128 g/m	1.41.6510F.2-A00A00/... /... = length in mm

Framing profiles

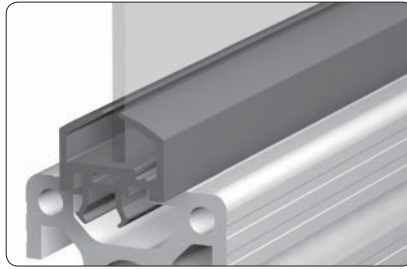

Application

The framing profile allows the installation of panels in closed frames

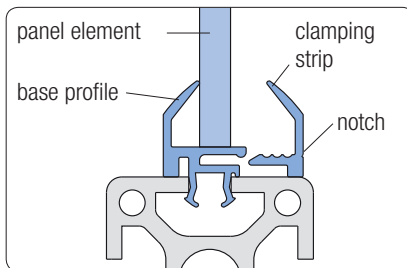

Assembly

1. Insert base profile in profile slot
2. Put panel element in position
3. Push clamping strip in position

Comments

The clamping strip is badged by a notch as a distinctive mark to the base profile

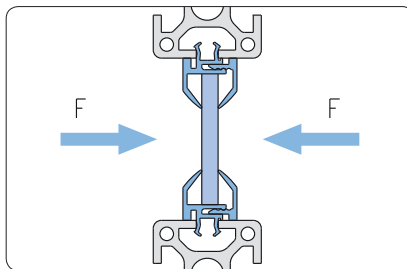

Maximum loading of framing profile:

$$F_{max} = 200 \text{ N/m}$$

For maximum loading of element be aware of the stability of used framing profile

Technical data

bar length: 6 m

material: • base body: PVC rigid, 98° Shore A

• lip: PVC soft, TPE 60° ± 5° Shore A, compatible with acrylic glass

temperature range: -20°C to +80°C

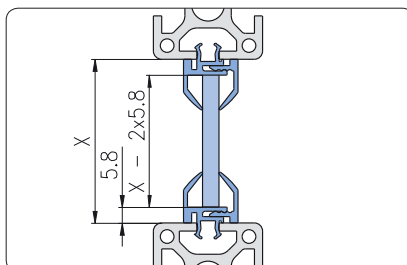
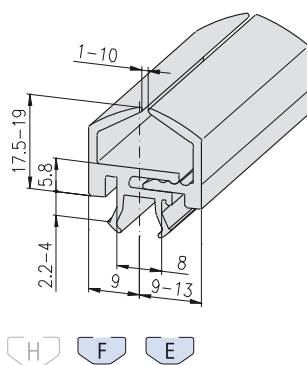

Comments

Suitable for panel elements from 1 to 10 mm thickness

Colours

grey: similar to RAL 7035

black: similar to RAL 9011

Description	Colour		Weight	Article-No.
Framing profile F/E	grey	bar	1.1 kg/bar	1.41.710.1.60
Framing profile F/E	grey	cut to length	181 g/m	1.41.710.1-A00A00/...
Framing profile F/E	black	bar	1.1 kg/bar	1.41.710.2.60
Framing profile F/E	black	cut to length	181 g/m	1.41.710.2-A00A00/...

/... = length in mm

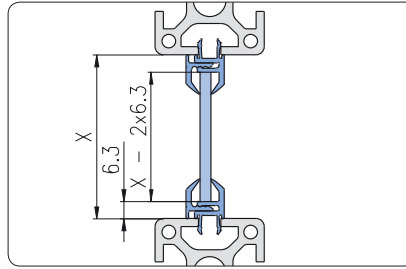
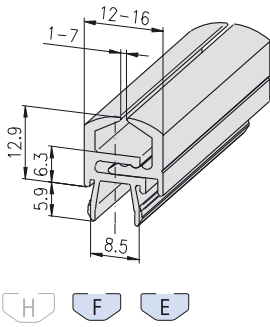



Comments

Suitable for panel elements from 1 to 7 mm thickness

Colours

grey: similar to RAL 7035
black: similar to RAL 9011

Description	Colour	Weight	Article-No.
Framing profile F/E, 1-7 mm	grey bar	960 g/bar	1.41.720107.1.60
 Framing profile F/E, 1-7 mm	grey cut to length	160 g/m	1.41.720107.1-A00A00/...
Framing profile F/E, 1-7 mm	black bar	960 g/bar	1.41.720107.2.60
 Framing profile F/E, 1-7 mm	black cut to length	160 g/m	1.41.720107.2-A00A00/...

/... = length in mm

Framing profiles

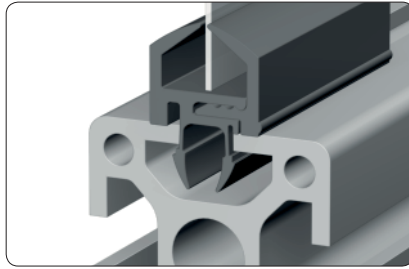

Application

The framing profile allows the installation of panels in closed frames

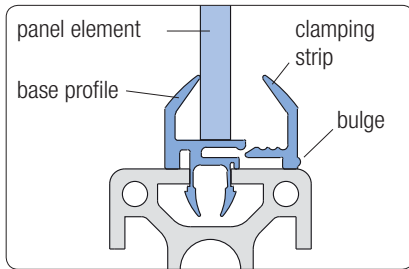

Assembly

1. Insert base profile in profile slot
2. Put panel element in position
3. Push clamping strip in position

Comments

The clamping strip is badged by a bulge as a distinctive mark to the base profile

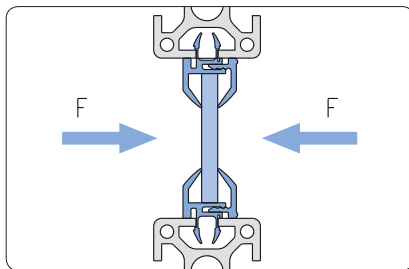

Maximum loading of framing profile:

$$F_{max} = 200 \text{ N/m}$$

For maximum loading of element be aware of the stability of used framing profile

Technical data

bar length: 6 m

material: • base body: PVC rigid, 98° Shore A

• lip: PVC soft, TPE 60° ± 5° Shore A, compatible with acrylic glass

temperature range: -20°C to +80°C

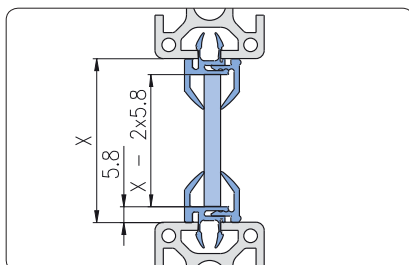
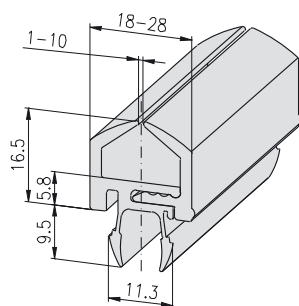



Comments

Suitable for panel elements from 1 to 10 mm thickness

Colours

grey: similar to RAL 7035

black: similar to RAL 9011

Description	Colour		Weight	Article-No.
Framing profile E	grey	bar	1.1 kg/bar	1.41.71E0110.1.60
 Framing profile E	grey	cut to length	181 g/m	1.41.71E0110.1-A00A00/...
Framing profile E	black	bar	1.1 kg/bar	1.41.71E0110.2.60
 Framing profile E	black	cut to length	181 g/m	1.41.71E0110.2-A00A00/...

/... = length in mm

Rubber cover-profiles

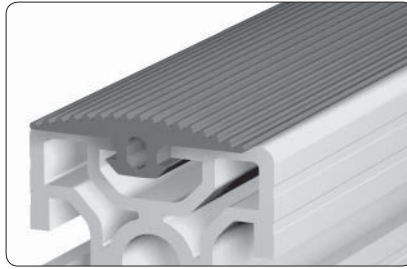

Application

Rubber cover-profiles for profile protection
Suitable for:

- door stop
- slide prevention on steps
- protection against damage
- handrails
- pads

Technical data

length of ring: 20 m
material: NBR, hardness 80 Shore A
oil and water resistant
colour: black

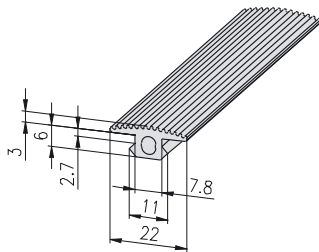

Description

Description	Weight	Article-No.
Rubber cover-profile F, black ring	2.4 kg/ring	1.41.8F30.20
Rubber cover-profile F, black cut to length	120 g/m	1.41.8F30-A00A00/... /... = length in mm

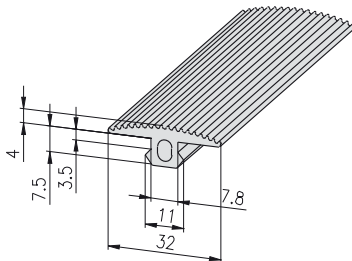

Description

Description	Weight	Article-No.
Rubber cover-profile E3, black ring	4.4 kg/ring	1.41.8E40.20
Rubber cover-profile E3, black cut to length	220 g/m	1.41.8E40-A00A00/... /... = length in mm

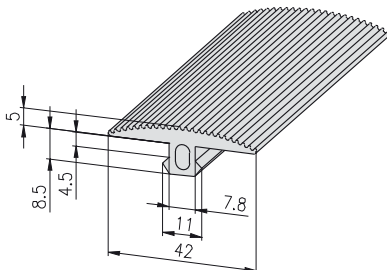

Description

Description	Weight	Article-No.
Rubber cover-profile E4, black ring	6.4 kg/ring	1.41.8E50.20
Rubber cover-profile E4, black cut to length	320 g/m	1.41.8E50-A00A00/... /... = length in mm

Cover caps



Application

Cover caps prevent dirt from entering and avoid lacerations.

Technical data

material: PA-GF
temperature range: -20°C to +85°C

Comments

Before mounting deburr core hole

for profiles without core hole

Rectangle

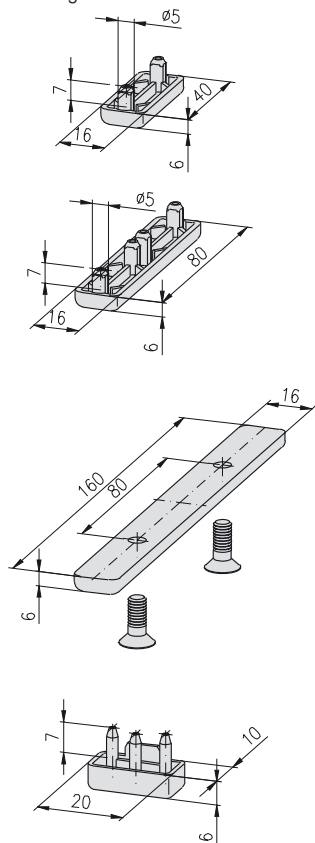

Description	Colour	Weight	Article-No.
Cover cap 16×40, E only for E-Slot	black	3.9 g	1.42.09016040.2

Description	Colour	Weight	Article-No.
Cover cap 16×80, E	grey	7.1 g	1.42.09016080.1
Cover cap 16×80, E only for E-Slot	black	7.1 g	1.42.09016080.2

Description	Weight	Article-No.
Cover cap set 16×160	22.0 g	1.42.09016160.0

Single parts	Pcs.	Colour	Weight	Article-No.
Cover cap 16×160	1	black	14.0 g	1.42.09016160.2
Countersunk screw DIN 7991 - M6×16	2		4.0 g	0.63.D07991.06016

Description	Colour	Weight	Article-No.
Cover cap 20×10	black	2 g	1.42.20201.2

for tube profile

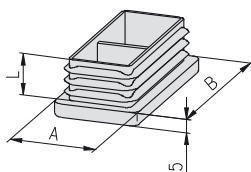

Description	A×B	L	Colour	Weight	Article-No.
Cover cap	30×60 for tube profile	14.5	black	10.2 g	1.42.217.030060.2
Cover cap	30×100 for tube profile	14.5	black	17.7 g	1.42.217.030100.2

for profiles with core hole- $\varnothing 6$

Soft

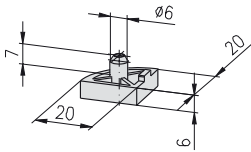

Description	Colour	Weight	Article-No.
Cover cap 20×20	grey	3 g	1.42.10200.1
Cover cap 20×20	black	3 g	1.42.10200.2

Square

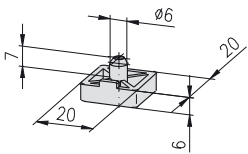

Description	Colour	Weight	Article-No.
Cover cap 20×20	grey	3 g	1.42.10202.1
Cover cap 20×20	black	3 g	1.42.10202.2

Rectangle

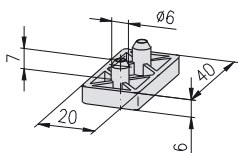

Description	Colour	Weight	Article-No.
Cover cap 20×40	grey	6 g	1.42.10204.1
Cover cap 20×40	black	6 g	1.42.10204.2

Square

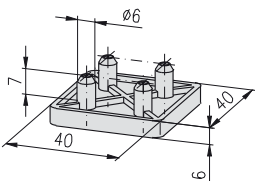

Description	Colour	Weight	Article-No.
Cover cap 40×40	black	6 g	1.42.10404.2

for profiles with core hole-Ø12

Soft

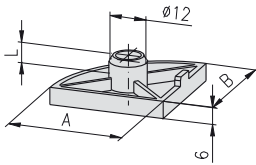

Description	A×B	L	Colour	Weight	Article-No.
Cover cap	30×30	7	grey	5 g	1.42.20300.1
Cover cap	30×30	7	black	5 g	1.42.20300.2
Cover cap	40×40	7	grey	8 g	1.42.20400.1
Cover cap	40×40	7	black	8 g	1.42.20400.2
Cover cap	45×45	14	black	10 g	1.42.2045000.2
Cover cap	50×50	7	grey	12 g	1.42.20500.1
Cover cap	50×50	7	black	12 g	1.42.20500.2

Round

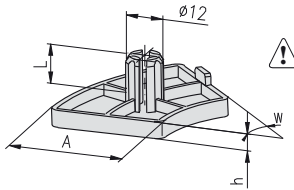

note "h" !

Description	A	W	h	L	Colour	Weight	Article-No.
Cover cap	40, round	30°	4	14	black	6 g	1.42.2040R30.2
Cover cap	40, round	45°	6	14	black	8 g	1.42.2040R45.2
Cover cap	40, round	60°	6	14	black	12 g	1.42.2040R60.2
Cover cap	40, round	90°	6	14	black	16 g	1.42.2040R90.2

Square

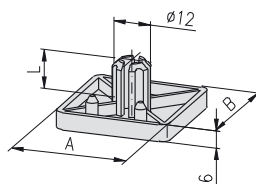

Description	A×B	L	Colour	Weight	Article-No.
Cover cap	30×30	14	grey	6 g	1.42.20303.1
Cover cap	30×30	14	black	6 g	1.42.20303.2
Cover cap	40×40	14	grey	10 g	1.42.20404.1
Cover cap	40×40	14	black	10 g	1.42.20404.2
Cover cap	45×45	14	black	12 g	1.42.2045045.2
Cover cap	50×50	7	grey	15 g	1.42.20505.1
Cover cap	50×50	7	black	15 g	1.42.20505.2
Cover cap	60×60	14	black	18 g	1.42.2060060.2

Rectangle

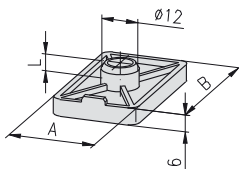

Description	A×B	L	Colour	Weight	Article-No.
Cover cap	20×30	7	black	4 g	1.42.20203.2
Cover cap	30×50	7	grey	8 g	1.42.20305.1
Cover cap	30×50	7	black	8 g	1.42.20305.2
Cover cap	45×60	14	black	12.1 g	1.42.2045060.2

Rectangle

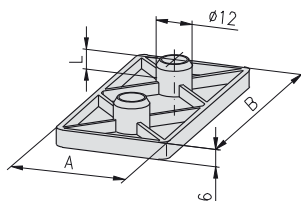

Description	A×B	L	Colour	Weight	Article-No.
Cover cap	30×60	7	grey	8 g	1.42.20306.1
Cover cap	30×60	7	black	8 g	1.42.20306.2
Cover cap	30×100	7	black	20 g	1.42.20310.2
1) Cover cap	30×150	7	black	27 g	1.42.20315.2
Cover cap	40×80	7	grey	18 g	1.42.20408.1
Cover cap	40×80	7	black	18 g	1.42.20408.2
Cover cap	45×90	14	black	20.5 g	1.42.2045090.2
Cover cap	50×100	7	grey	26 g	1.42.20510.1
Cover cap	50×100	7	black	26 g	1.42.20510.2
Cover cap	50×150	7	black	40 g	1.42.20515.2
Cover cap	60×90	14	black	25.9 g	1.42.2060090.2

1) only for E-Slot

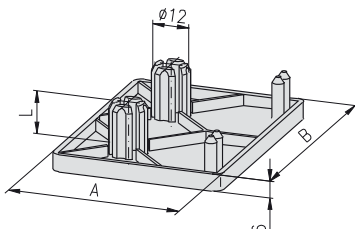

Description	A×B	L	Colour	Weight	Article-No.
Cover cap	60×80	14	black	21.4 g	1.42.2060080.2

for profiles with core hole-Ø12

Square

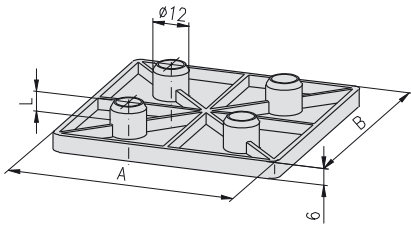

Description	A×B	L	Colour	Weight	Article-No.
Cover cap	80×80	7	black	34 g	1.42.20808.2
Cover cap	90×90	14	black	42 g	1.42.2090090.2
Cover cap	100×100	7	black	52 g	1.42.21010.2

Rectangle

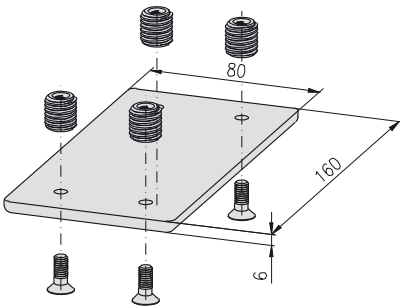

Description	Weight	Article-No.
Cover cap set 80×160	172.0 g	1.42.2080160.0
Single parts		
Description	Pcs.	Colour
Cover cap 80×160	1	black
Threaded insert M14/M6	4	
Countersunk screw DIN 7991 - M6×16	4	

Ø48 for hand rail profile

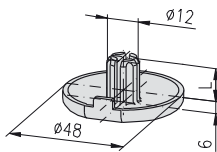

Technical data

material: PA-GF

Description	L	Colour	Weight	Article-No.
Cover cap Ø48 for hand rail profile	14	grey	1.8 g	1.42.2048R00.1
Cover cap Ø48 for hand rail profile	14	black	1.8 g	1.42.2048R00.2

Cover plugs

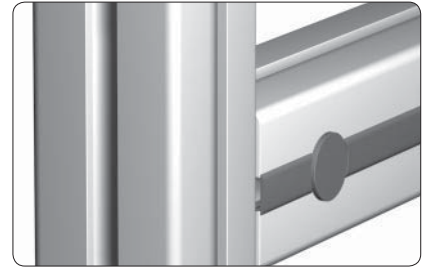

Cover plug in combination with cover profile

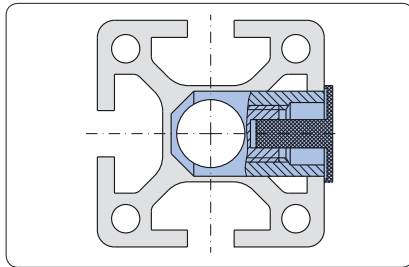

Application

The cover plug allows the closing of the connector cross bushing bore

Technical data

material: PE

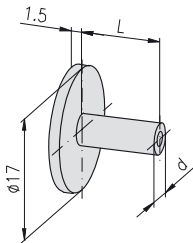

Description	Colour	L	d	Weight	Article-No.
Cover plug 20	grey	3.5	Ø4.3	2 g	1.42.502.1
Cover plug 20	black	3.5	Ø4.3	2 g	1.42.502.2
Cover plug 30	grey	6.0	Ø5.3	3 g	1.42.503.1
Cover plug 30	black	6.0	Ø5.3	3 g	1.42.503.2
Cover plug 40	grey	11.0	Ø5.3	4 g	1.42.504.1
Cover plug 40	black	11.0	Ø5.3	4 g	1.42.504.2
Cover plug 50	grey	16.0	Ø5.3	5 g	1.42.505.1
Cover plug 50	black	16.0	Ø5.3	5 g	1.42.505.2

Cover plugs domed

C

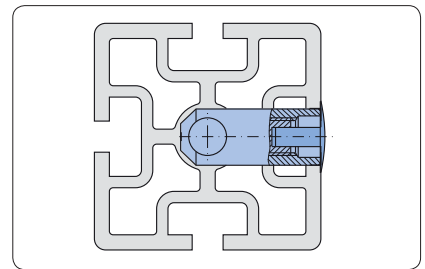

Application

The cover plug allows the closing of the connector cross bushing bore

Technical data

material: PE

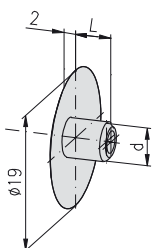

Description	Colour	L	d	Weight	Article-No.
Cover plug 20 domed	grey	3.5	Ø4.3	0.2 g	1.42.5120.1
Cover plug 20 domed	black	3.5	Ø4.3	0.2 g	1.42.5120.2
Cover plug 30 domed	grey	6.0	Ø5.3	0.3 g	1.42.5130.1
Cover plug 30 domed	black	6.0	Ø5.3	0.3 g	1.42.5130.2
Cover plug 40 domed	grey	11.0	Ø5.3	0.4 g	1.42.5140.1
Cover plug 40 domed	black	11.0	Ø5.3	0.4 g	1.42.5140.2
Cover plug 45 domed	grey	12.5	Ø5.3	0.4 g	1.42.5145.1
Cover plug 45 domed	black	12.5	Ø5.3	0.4 g	1.42.5145.2
Cover plug 50 domed	grey	15.0	Ø5.3	0.5 g	1.42.5150.1
Cover plug 50 domed	black	15.0	Ø5.3	0.5 g	1.42.5150.2
Cover plug 60 domed	grey	20.0	Ø5.3	0.7 g	1.42.5160.1
Cover plug 60 domed	black	20.0	Ø5.3	0.7 g	1.42.5160.2

Cover caps for tubes

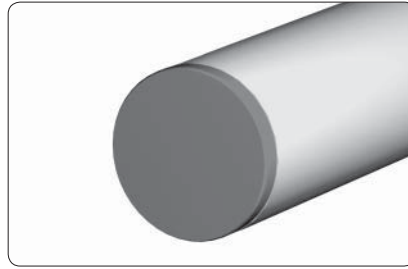

Application

The cover cap allows the closing of the aluminium tube (inner tube $\varnothing = d$)

Technical data

material: PE

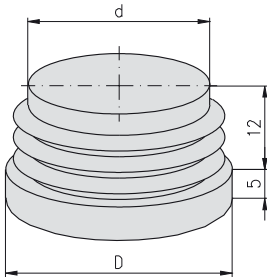

Description	D	Colour	d	Weight	Article-No.
Tube cover cap	Ø20	grey	Ø16	1.8 g	1.42.6020.1
Tube cover cap	Ø20	black	Ø16	1.8 g	1.42.6020.2
Tube cover cap	Ø30	grey	Ø24	3.4 g	1.42.6030.1
Tube cover cap	Ø30	black	Ø24	3.4 g	1.42.6030.2
Tube cover cap	Ø40	grey	Ø32	5.3 g	1.42.6040.1
Tube cover cap	Ø40	black	Ø32	5.3 g	1.42.6040.2

Cover caps for screw bores

C

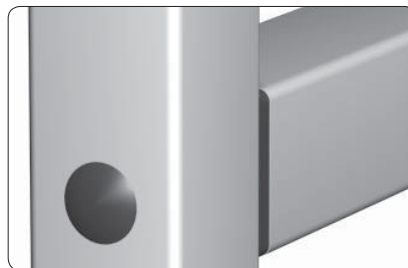

Application

The cover plug allows the closing of the screw bore

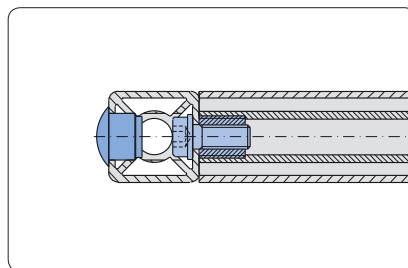

Profile 30

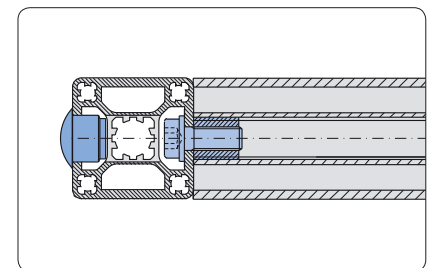

Profile 40

Technical data

material: PE

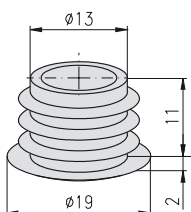

Description	Colour	Weight	Article-No.
Cover plug	Ø15 grey	1.3 g	1.42.6114.1
Cover plug	Ø15 black	1.3 g	1.42.6114.2

Radius covers

C

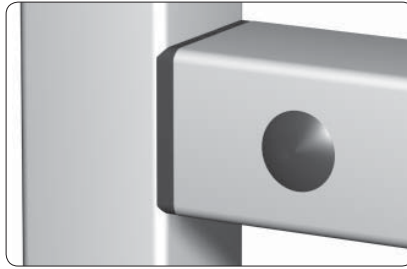

Application

For covering the exterior profile radius

Technical data

material: PA-GF

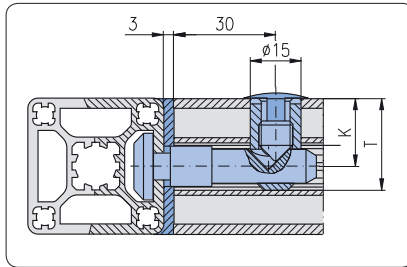

Drill dimensions by use of radius covers
(dimensions K, T → connector-cross bushings 1.2B)

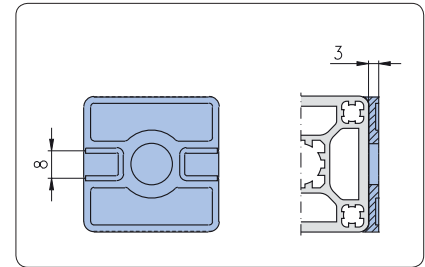

For mounting of panels the slots can be broken out

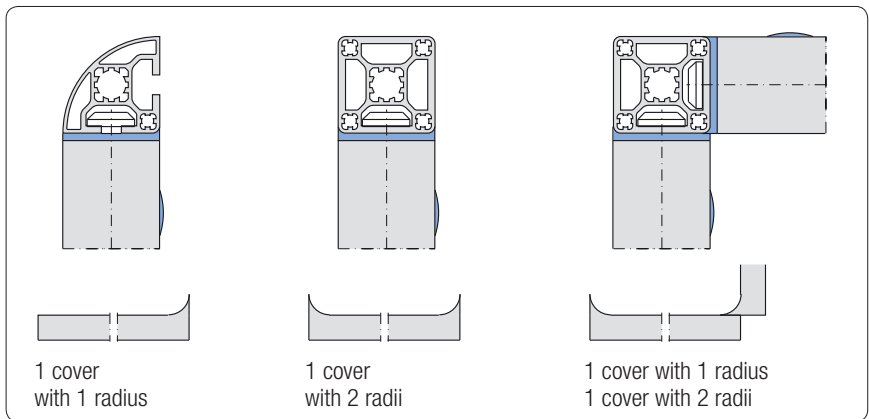

Mounting-Variations

Square
with one radius

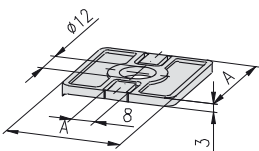

Description	A	Colour	Weight	Article-No.
Radius cover 1R	30	grey	3.1 g	1.43.10030030.1
Radius cover 1R	30	black	3.1 g	1.43.10030030.2
Radius cover 1R	40	grey	6.1 g	1.43.10040040.1
Radius cover 1R	40	black	6.1 g	1.43.10040040.2
Radius cover 1R	45	grey	5.4 g	1.43.10045045.1
Radius cover 1R	45	black	5.4 g	1.43.10045045.2

Rectangle
with one radius

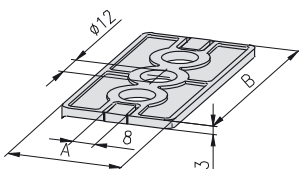

Description	A	B	Colour	Weight	Article-No.
Radius cover 1R	30	60	grey	5.8 g	1.43.10030060.1
Radius cover 1R	30	60	black	5.8 g	1.43.10030060.2
Radius cover 1R	40	80	grey	11.8 g	1.43.10040080.1
Radius cover 1R	40	80	black	11.8 g	1.43.10040080.2
Radius cover 1R	45	90	grey	10.7 g	1.43.10045090.1
Radius cover 1R	45	90	black	10.7 g	1.43.10045090.2

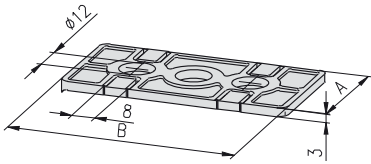
Rectangle 90°
 with one radius

Description	A	B	Colour	Weight	Article-No.
Radius cover 1R	30	60	grey	5.8 g	1.43.11030060.1
Radius cover 1R	30	60	black	5.8 g	1.43.11030060.2
Radius cover 1R	40	80	grey	11.8 g	1.43.11040080.1
Radius cover 1R	40	80	black	11.8 g	1.43.11040080.2
Radius cover 1R	45	90	grey	10.8 g	1.43.11045090.1
Radius cover 1R	45	90	black	10.8 g	1.43.11045090.2

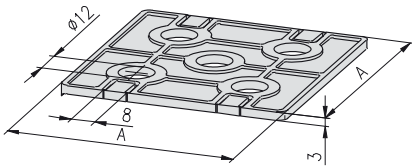
Square
 with one radius

Description	A	Colour	Weight	Article-No.
Radius cover 1R	60	grey	12.0 g	1.43.10060060.1
Radius cover 1R	60	black	12.0 g	1.43.10060060.2
Radius cover 1R	80	grey	24.0 g	1.43.10080080.1
Radius cover 1R	80	black	24.0 g	1.43.10080080.2

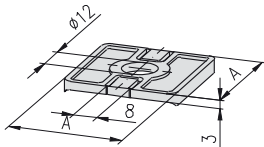
Square
 with two radii

Description	A	Colour	Weight	Article-No.
Radius cover 2R	30	grey	3.2 g	1.43.20030030.1
Radius cover 2R	30	black	3.2 g	1.43.20030030.2
Radius cover 2R	40	grey	6.3 g	1.43.20040040.1
Radius cover 2R	40	black	6.3 g	1.43.20040040.2
Radius cover 2R	45	grey	5.6 g	1.43.20045045.1
Radius cover 2R	45	black	5.6 g	1.43.20045045.2

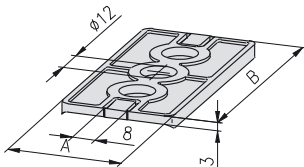
Rectangle
 with two radii

Description	A	B	Colour	Weight	Article-No.
Radius cover 2R	30	60	grey	6.0 g	1.43.20030060.1
Radius cover 2R	30	60	black	6.0 g	1.43.20030060.2
Radius cover 2R	40	80	grey	12.0 g	1.43.20040080.1
Radius cover 2R	40	80	black	12.0 g	1.43.20040080.2
Radius cover 2R	45	90	grey	10.9 g	1.43.20045090.1
Radius cover 2R	45	90	black	10.9 g	1.43.20045090.2

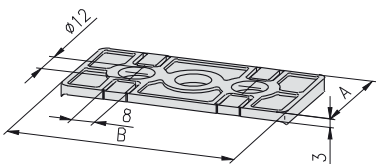
Rectangle 90°
 with two radii

Description	A	B	Colour	Weight	Article-No.
Radius cover 2R	30	60	grey	6.0 g	1.43.21030060.1
Radius cover 2R	30	60	black	6.0 g	1.43.21030060.2
Radius cover 2R	40	80	grey	12.0 g	1.43.21040080.1
Radius cover 2R	40	80	black	12.0 g	1.43.21040080.2
Radius cover 2R	45	90	grey	11.0 g	1.43.21045090.1
Radius cover 2R	45	90	black	11.0 g	1.43.21045090.2

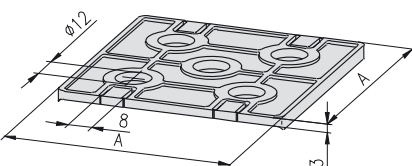
Square
 with two radii

Description	A	Colour	Weight	Article-No.
Radius cover 2R	60	grey	12.0 g	1.43.20060060.1
Radius cover 2R	60	black	12.0 g	1.43.20060060.2
Radius cover 2R	80	grey	24.0 g	1.43.20080080.1
Radius cover 2R	80	black	24.0 g	1.43.20080080.2

Radius compensations

C

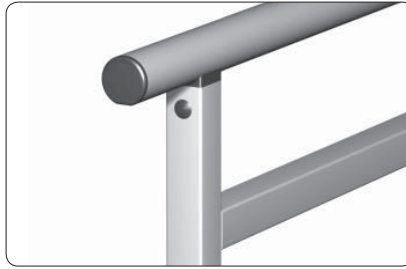

Post: Profile 40x40

Application

Radius compensation for hand rails
 ↳ Profile applications 1.1E.03

Comments

Angled joints at any required angle
 Not suitably for the use with tilted hand rails

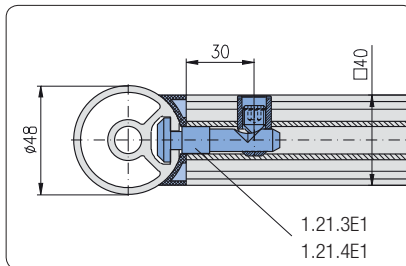

Working dimensions for hand rail straight with radius compensation

Technical data

material: PA-GF

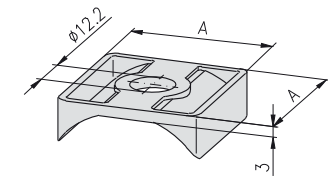

- 16
- 20
- 30
- 40
- 45
- 50
- 60

Description	AxA	Colour	Weight	Article-No.
Radius compensations	30x30	grey	4.0 g	1.43.71030030.1
Radius compensations	30x30	black	4.0 g	1.43.71030030.2
Radius compensations	40x40	grey	7.0 g	1.43.71040040.1
Radius compensations	40x40	black	7.0 g	1.43.71040040.2

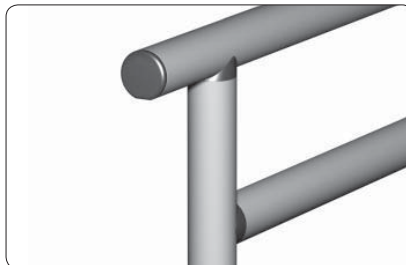

Post: Profile Ø48

Technical data

material: PA-GF

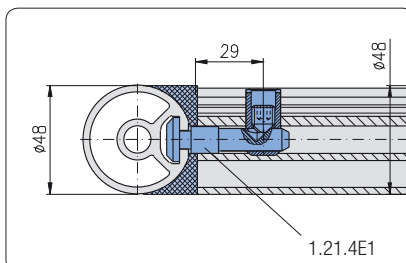

Working dimensions for hand rail straight with radius compensation

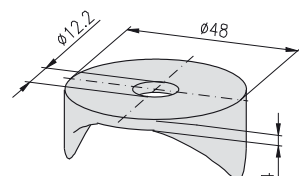

Description	Colour	Weight	Article-No.
Radius compensations Ø48	grey	4.0 g	1.43.71048000.1
Radius compensations Ø48	black	4.0 g	1.43.71048000.2

Levelling feet

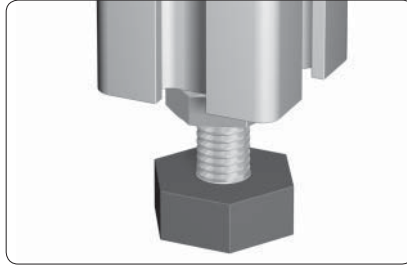

Assembly

Fastening in core hole Ø6 mm with thread M8

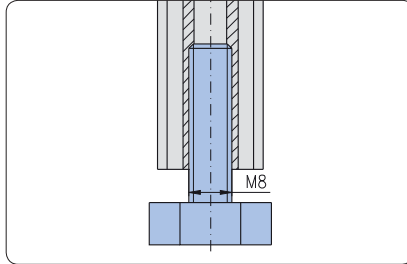

Fastening in core hole Ø6 mm with thread M8

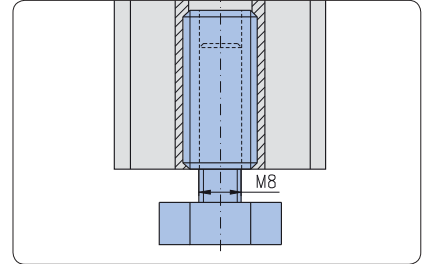

Fastening in core hole Ø12 with threaded insert M14/M8

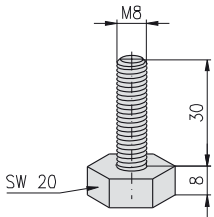

Technical data

- material:
- plate: PE-HD
 - screw: steel, galvanised
- max. static load: 2,500 N

Description

Floor levelling screw, SW20, M8×30

Weight

20 g

Article-No.

1.44.002003

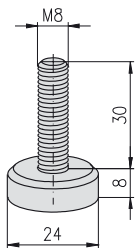

Technical data

- material:
- plate: PE-HD
 - screw: steel, galvanised
- max. static load: 2,500 N

Description

Floor levelling screw, Ø24, M8×30

Weight

22 g

Article-No.

1.44.002403

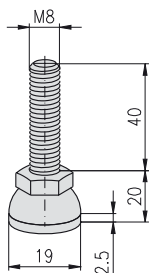

Technical data

- material:
- foot plate: PA, black
 - threaded bolt: steel, galvanised
- max. static load: 500 N
with anti-slip-disc

Description

Levelling foot, PA, 20 M8×40

Weight

24 g

Article-No.

1.44.003020

Hand adjustable feet

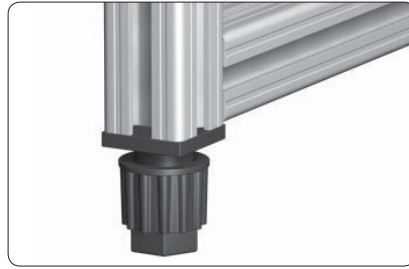

Application

For manual levelling of benches, tables and light bases.

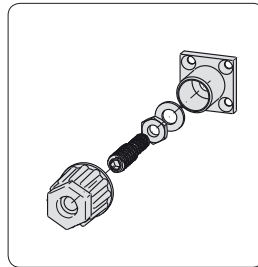

Height adjustable alternative by hand or with tool

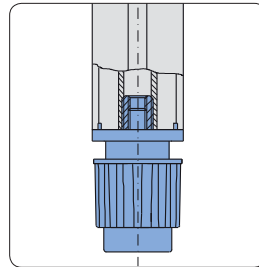

Fastening in core hole

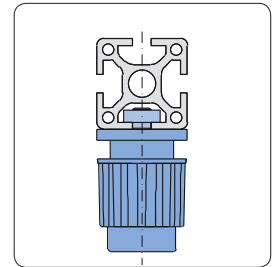

Fastening in slot

Technical data

material:

- capsule: PA, black
- spindle, nut and washer: steel galvanised

max. static load: 1,500 N

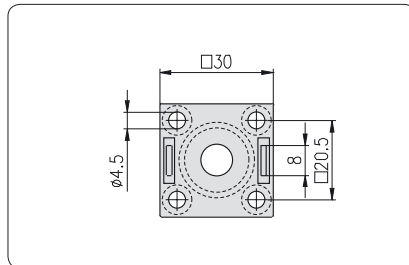
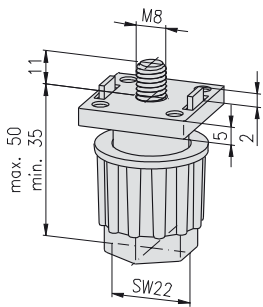

Description

Hand adjustable foot 30

Weight

40 g

Article-No.

1.44.203008

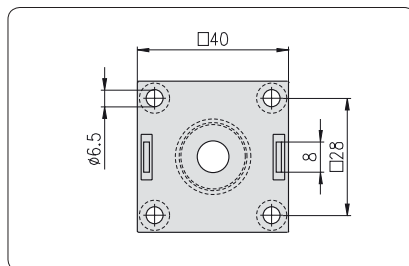
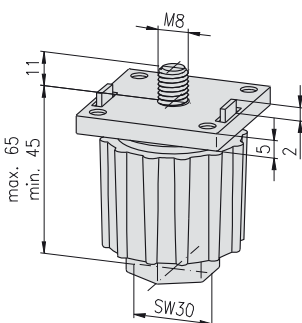

Description

Hand adjustable foot 40

Weight

78 g

Article-No.

1.44.204008

Levelling feet

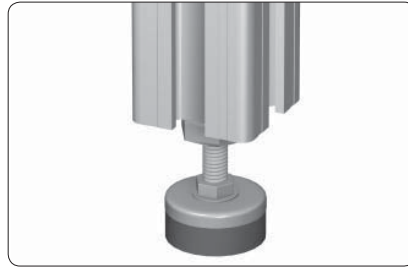

Assembly

Fastening in core hole with threaded insert
M14/M10

For profiles with core hole-Ø 12 mm

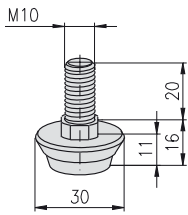

Technical data

material:

- foot plate: PA, black
- cap: steel, galvanised
- screw thread: steel, galvanised
- max. static load: 1,500 N

Description

Levelling furniture foot, Ø30, M10x18

Weight

Article-No.

24 g

1.44.303002

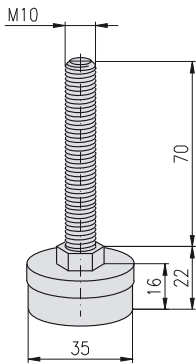

Technical data

material:

- foot plate: PA, black
- cap: steel, galvanised
- screw thread: steel, galvanised
- max. static load: 1,500 N

Description

Levelling foot, Ø35, M10x70

Weight

Article-No.

70 g

1.44.303507

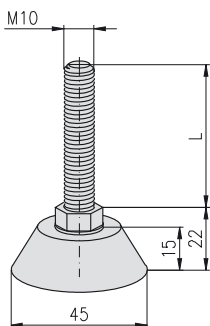

Technical data

material:

- foot plate: PA, black
- screw thread: steel, galvanised
- max. static load: 1,500 N

Description

Levelling foot, Ø45, M10x50

Levelling foot, Ø45, M10x70

L

Weight

Article-No.

60 g

1.44.304505

69 g

1.44.304507

Adjustable tilt-feet

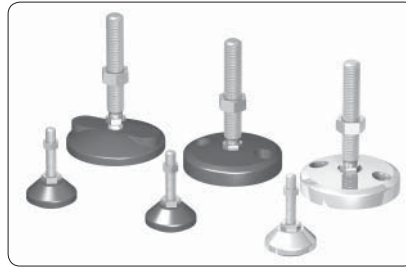

Application

Adjustable tilt-feet for gradual height adjustment of sub-assemblies such as:

- tables
- bases
- shelves
- stands



Fastening in core hole thread M14

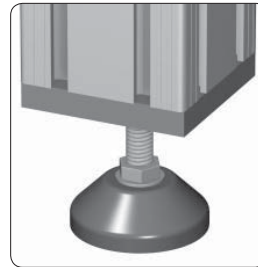

Fastening with base plate, for profiles without centric core hole



Fastening by press-fit threaded insert across the profile

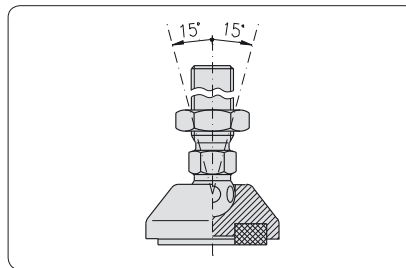

Levelling via ball and ball socket $\pm 15^\circ$

Comments

Infinitely variable adjustable tilt-feet for use either with:

- anti-slip disc
- cushion element

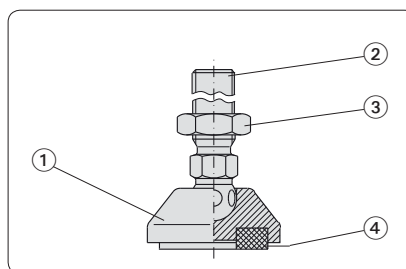

Adjustable tilt-feet - Single parts						
Pos.	Description	Material				
		PA	GD-Zn	Steel	Stainl. steel	NBR 1.4305
	Adjustable tilt-foot-					
①	plate	•	•		•	
②	spindle			•	•	
③	nut			•	•	
④	anti-slip disc cushion element					• •

Adjustable tilt-foot plates without mounting holes

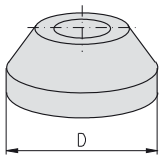
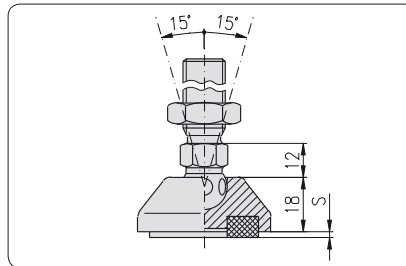
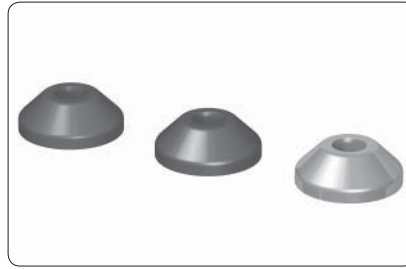

Design without mounting holes

Technical data

material:

PA: PA-GF, black

GD-Zn: GD-Zn, black powder-coated

stainless: stainless steel 1.4305

F = static load max. in kN

S = height of:

- anti-slip disc (S = 2 mm)

- cushion element (S = 10 mm)

	Description	D	F	Weight	Article-No.
PA	Adjustable tilt-foot plate PA, 30	Ø29	5 kN	8 g	1.44.411030
	Adjustable tilt-foot plate PA, 40	Ø39	9 kN	13 g	1.44.411040
	Adjustable tilt-foot plate PA, 45	Ø44	9 kN	15 g	1.44.411045
	Adjustable tilt-foot plate PA, 50	Ø49	9 kN	16 g	1.44.411050
	Adjustable tilt-foot plate PA, 60	Ø59	9 kN	22 g	1.44.411060
GD-Zn	Adjustable tilt-foot plate GD-Zn, 30	Ø29	20 kN	48 g	1.44.431030
	Adjustable tilt-foot plate GD-Zn, 40	Ø39	30 kN	70 g	1.44.431040
	Adjustable tilt-foot plate GD-Zn, 45	Ø44	30 kN	90 g	1.44.431045
	Adjustable tilt-foot plate GD-Zn, 50	Ø49	30 kN	126 g	1.44.431050
	Adjustable tilt-foot plate GD-Zn, 60	Ø59	30 kN	160 g	1.44.431060
	Adjustable tilt-foot plate GD-Zn, 80	Ø79	30 kN	260 g	1.44.431080
	Adjustable tilt-foot plate GD-Zn, 100	Ø99	35 kN	400 g	1.44.431100
	Adjustable tilt-foot plate GD-Zn, 120	Ø119	35 kN	584 g	1.44.431120
Stainless steel	C R Adjustable tilt-foot plate, 30	Ø29	20 kN	62 g	1.44.431030V
	Adjustable tilt-foot plate, 40	Ø39	30 kN	99 g	1.44.431040V
	Adjustable tilt-foot plate, 45	Ø44	30 kN	123 g	1.44.431045V
	Adjustable tilt-foot plate, 50	Ø49	35 kN	158 g	1.44.431050V
	Adjustable tilt-foot plate, 60	Ø59	35 kN	218 g	1.44.431060V
	Adjustable tilt-foot plate, 80	Ø79	35 kN	380 g	1.44.431080V
	Adjustable tilt-foot plate, 100	Ø99	40 kN	605 g	1.44.431100V
	Adjustable tilt-foot plate, 120	Ø119	40 kN	844 g	1.44.431120V

Adjustable tilt-foot plates with mounting holes

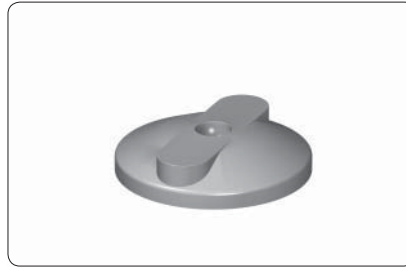
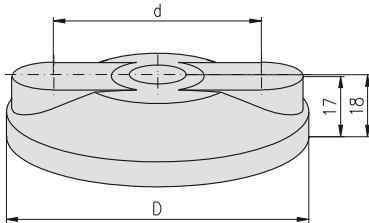

Technical data

material:
PA: PA-GF, black
F = static load max. in kN

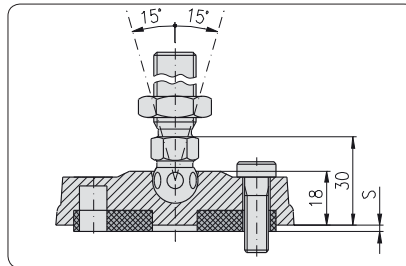

Comments

The holes for fastening screws are closed on the upper side and can be bored open if required.

- S = height of:
- anti-slip disc (S = 2 mm)
 - cushion element (S = 10 mm)

Design with mounting holes

PA

Description	D	d	F	Weight	Article-No.
Adjustable tilt-foot plate PA, 80	Ø79	Ø54	9 kN	46 g	1.44.411080
Adjustable tilt-foot plate PA, 100	Ø99	Ø74	9 kN	86 g	1.44.411100
Adjustable tilt-foot plate PA, 120	Ø119	Ø94	9 kN	104 g	1.44.411120

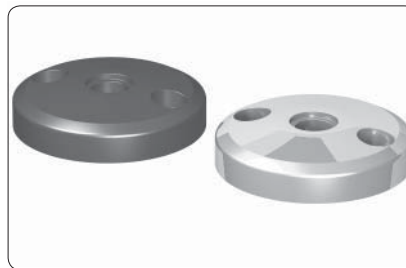

Technical data

material:
GD-Zn: GD-Zn, black powder-coated
stainless: stainless steel 1.4305 pickled and passivated
F = static load max. in kN

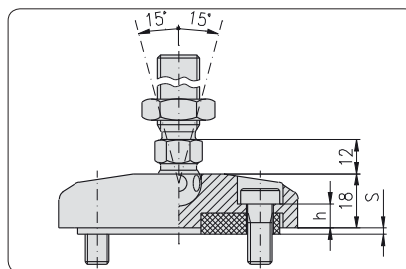
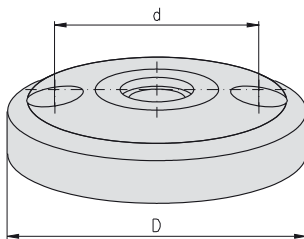

Comments

Fixing drilling with counterbore DIN 74 - M8 for cap-screw DIN 6912-M8

- S = height of:
- anti-slip disc (S = 2 mm)
 - cushion element (S = 10 mm)

Design with mounting holes

GD-Zn

Description	D	h	d	F	Weight	Article-No.
Adjustable tilt-foot plate steel, 80	Ø79	11.5	Ø54	30 kN	260 g	1.44.432080
Adjustable tilt-foot plate steel, 100	Ø99	11.5	Ø74	35 kN	377 g	1.44.432100
Adjustable tilt-foot plate steel, 120	Ø119	11.5	Ø94	35 kN	570 g	1.44.432120

Stainless steel



Adjustable tilt-foot plate stain., 80	Ø79	11.0	Ø54	30 kN	354 g	1.44.432080V
Adjustable tilt-foot plate stain., 100	Ø99	11.0	Ø74	40 kN	587 g	1.44.432100V
Adjustable tilt-foot plate stain., 120	Ø119	11.0	Ø94	40 kN	830 g	1.44.432120V

Adjustable tilt-foot spindles



Technical data

material:
 steel: steel, galvanised
 stainless: stainless steel 1.4305,
 pickled and passivated

Steel

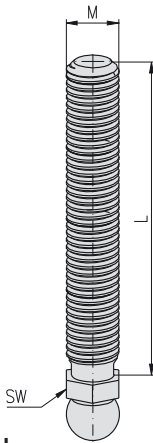

Stainless steel

C R

Description	G × L	SW	Weight	Article-No.
Adjustable tilt-foot spindle, steel	M8 × 40	14	17 g	1.44.4608040
Adjustable tilt-foot spindle, steel	M8 × 80	14	31 g	1.44.4608080
Adjustable tilt-foot spindle, steel	M10 × 45	14	37 g	1.44.4610045
Adjustable tilt-foot spindle, steel	M10 × 90	14	51 g	1.44.4610090
Adjustable tilt-foot spindle, steel	M12 × 66	14	56 g	1.44.4612066
Adjustable tilt-foot spindle, steel	M12 × 100	14	79 g	1.44.4612100
Adjustable tilt-foot spindle, steel	M14 × 66	14	87 g	1.44.4614066
Adjustable tilt-foot spindle, steel	M14 × 100	14	119 g	1.44.4614100
Adjustable tilt-foot spindle, steel	M14 × 150	14	166 g	1.44.4614150
Adjustable tilt-foot spindle, steel	M16 × 66	17	111 g	1.44.4616066
Adjustable tilt-foot spindle, steel	M16 × 100	17	155 g	1.44.4616100
Adjustable tilt-foot spindle, steel	M16 × 150	17	220 g	1.44.4616150
Adjustable tilt-foot spindle, steel	M20 × 100	22	237 g	1.44.4620100
Adjustable tilt-foot spindle, steel	M20 × 150	22	331 g	1.44.4620150
Adjustable tilt-foot spindle, stainless	M14 × 66	14	87 g	1.44.4614066V
Adjustable tilt-foot spindle, stainless	M14 × 88	14	104 g	1.44.4614088V
Adjustable tilt-foot spindle, stainless	M14 × 100	14	119 g	1.44.4614100V
Adjustable tilt-foot spindle, stainless	M14 × 125	14	138 g	1.44.4614125V
Adjustable tilt-foot spindle, stainless	M14 × 150	14	166 g	1.44.4614150V

Adjustable tilt-foot nuts



Technical data

material:
 steel: steel, galvanised
 stainless: stainless steel 1.4305,
 pickled and passivated

Steel

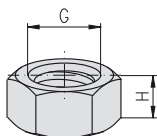

Stainless steel

C R

Description	G	H	Weight	Article-No.
Adjustable tilt-foot nut	M8	5	5 g	1.44.46M08
Adjustable tilt-foot nut	M10	6	8 g	1.44.46M10
Adjustable tilt-foot nut	M12	7	10 g	1.44.46M12
Adjustable tilt-foot nut	M14	8	16 g	1.44.46M14
Adjustable tilt-foot nut	M16	8	17 g	1.44.46M16
Adjustable tilt-foot nut	M20	9	35 g	1.44.46M20
Adjustable tilt-foot nut, stainless	M14	8	16 g	1.44.46M14V

Adjustable tilt-foot anti-slip discs

C

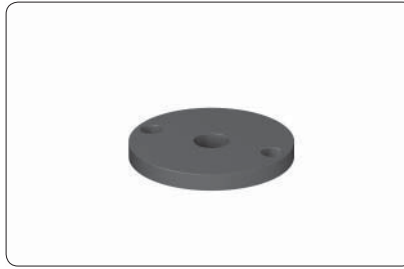

Application

Element for protection against dislocation and floor damage

Technical data

material: NBR, oil and water resistant
 colour: black
 hardness: 80 Shore A
 F = static load max. in KN

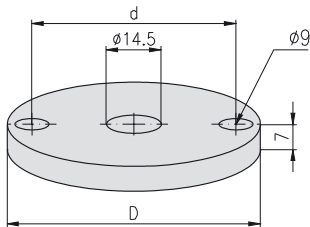
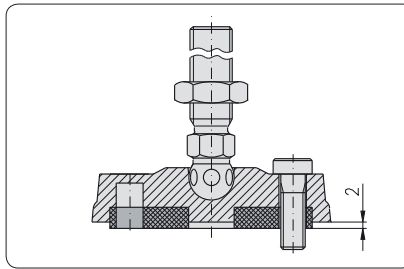

Description

	D	d	F	Weight	Article-No.
Adj. tilt-foot anti-slip disc for plate 30	Ø20	-	5 kN	2.0 g	1.44.471030
Adj. tilt-foot anti-slip disc for plate 40	Ø30	-	6 kN	4.0 g	1.44.471040
Adj. tilt-foot anti-slip disc for plate 45	Ø35	-	7 kN	5.5 g	1.44.471045
Adj. tilt-foot anti-slip disc for plate 50	Ø39	-	8 kN	7.5 g	1.44.471050
Adj. tilt-foot anti-slip disc for plate 60	Ø49	-	9 kN	12.0 g	1.44.471060
Adj. tilt-foot anti-slip disc for plate 80	Ø67	Ø54	10 kN	22.0 g	1.44.471080
Adj. tilt-foot anti-slip disc for plate 100	Ø87	Ø74	10 kN	36.0 g	1.44.471100
Adj. tilt-foot anti-slip disc for plate 120	Ø107	Ø94	10 kN	57.0 g	1.44.471120

Adjustable tilt-foot cushion elements

C



Application

Cushion elements

Technical data

material: NBR, oil and water resistant
 colour: black
 hardness: 70 Shore A
 F = static load max. in N

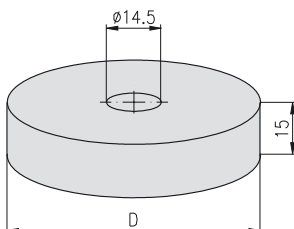
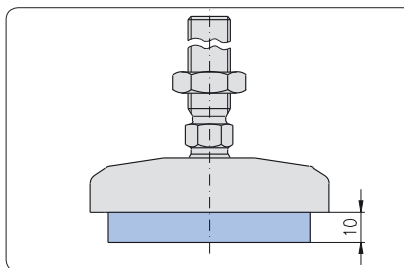

Description

	D	F	Weight	Article-No.
Adj. tilt-foot cushion element for plate 40	Ø30	150 N	14 g	1.44.472040
Adj. tilt-foot cushion element for plate 45	Ø35	175 N	19 g	1.44.472045
Adj. tilt-foot cushion element for plate 50	Ø39	200 N	24 g	1.44.472050
Adj. tilt-foot cushion element for plate 60	Ø49	250 N	35 g	1.44.472060
Adj. tilt-foot cushion element for plate 80	Ø67	500 N	68 g	1.44.472080
Adj. tilt-foot cushion element for plate 100	Ø87	800 N	118 g	1.44.472100
Adj. tilt-foot cushion element for plate 120	Ø107	1,200 N	188 g	1.44.472120

Angular adjusting feet

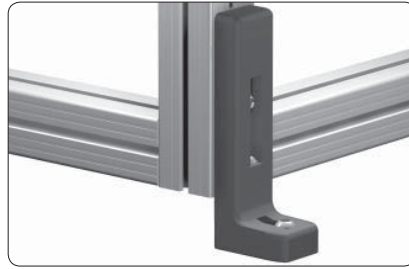

Application

For fastening of frames to floor or wall

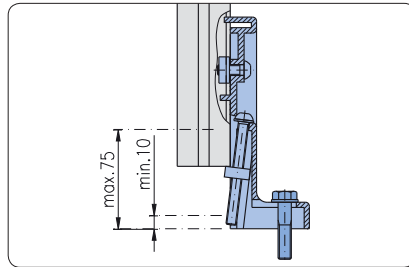

Technical data

material:

- base body: GD-Al, black
- nuts: steel galvanised
- screws: steel galvanised
- max. static load: 10,000 N

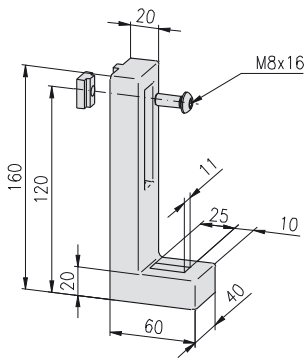

Delivery unit

- base body
- nut M8
- screw M8x16 - 10.9

Description

Angular adjusting foot without adjusting screw

Weight

Article-No.

468 g

1.44.716001

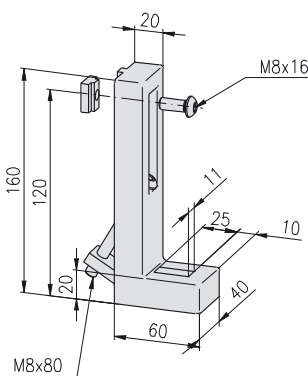

Delivery unit:

- base body
- nut M8
- screw M8x16 - 10.9
- screw M8x80 - 10.9
- square nut

Description

Angular adjusting foot with adjusting screw

Weight

Article-No.

519 g

1.44.716002

**Base foot
for profile 40×40**

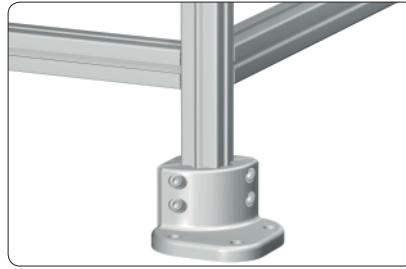

Application

Base feet for fastening profiles and frames to floor or wall

Technical data

material: GD-Zn

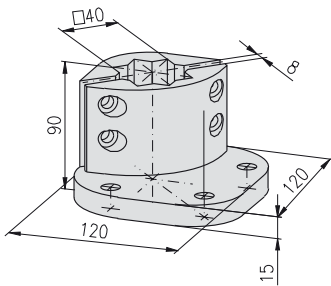
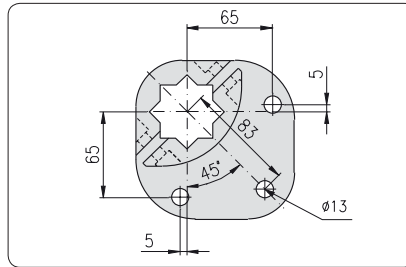

Description

Base foot for profile 40×40

Weight

979 g

Article-No.

1.44.83040

Floor mounting set

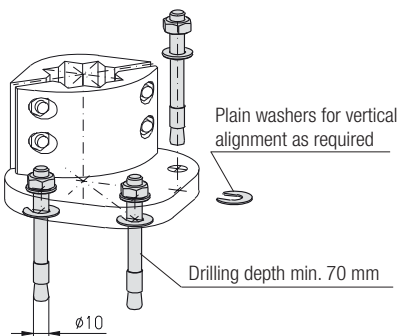

Description

Floor mounting set 3 MKT

Weight

202.3 g

Article-No.

1.44.83BB

Single parts

Pin anchor MKT, B10/20/95

Pcs.

3

Weight

65.3 g

Article-No.

0.66.MKT.B1020/95

Plain washer 1×Ø24/11

8

0.8 g

1.44.89011324

Base feet

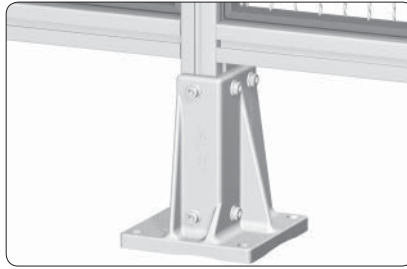

Application

Base feet for fastening profiles and frames to floor or wall

Technical data

material: GK AlZn 10Si8Mg

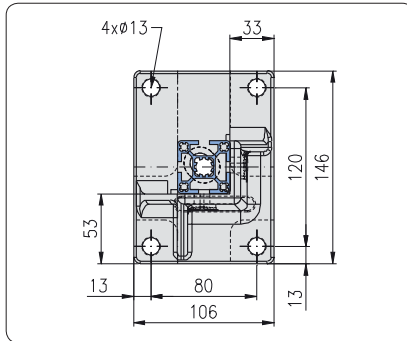
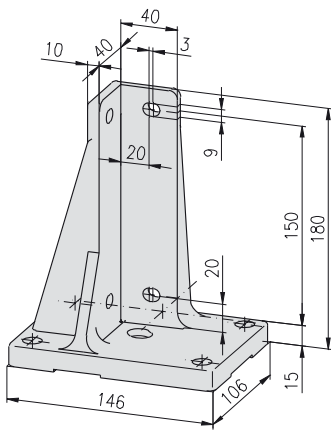

40x40, type 1, left

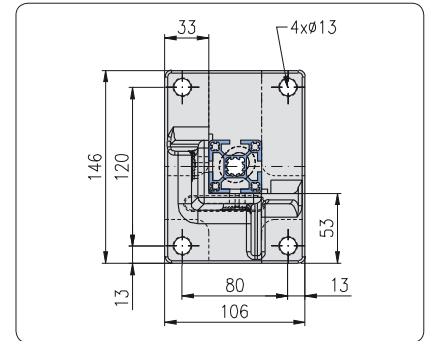

40x40, type 1, right

Comments

3D picture shows type 1, right
mirror-inverted: type 1, left

Mounting sets (↔ 191, 192)

Floor mounting set 4 MKT
Profile mounting set 4 EM8

Description

Description	for profile	Weight	Article-No.
Base foot 40x40, type 1, left	40x40, 45x45	1.06 kg	1.44.84.4040.00L
Base foot 40x40, type 1, right	40x40, 45x45	1.06 kg	1.44.84.4040.00R

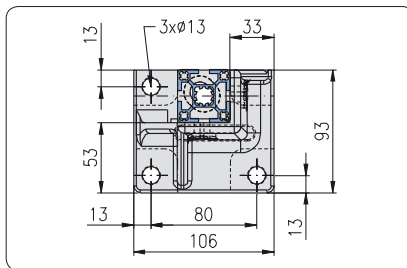
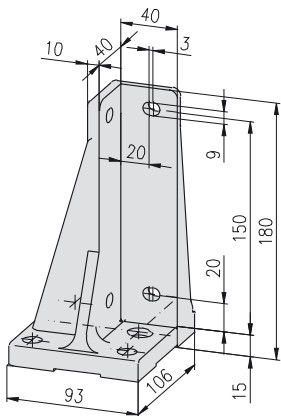

40x40, type 2, left

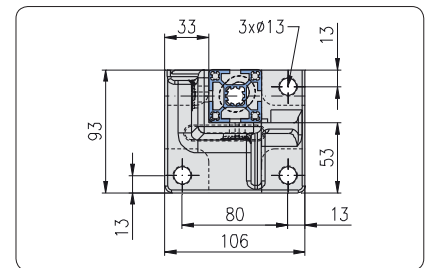

40x40, type 2, right

Comments

3D picture shows type 2, right
mirror-inverted: type 2, left

Mounting sets (↔ 191, 192)

Floor mounting set 3 MKT
Profile mounting set 4 EM8

Description

Description	for profile	Weight	Article-No.
Base foot 40x40, type 2, left	40x40	0.83 kg	1.44.84.4040.40L
Base foot 40x40, type 2, right	40x40	0.83 kg	1.44.84.4040.40R

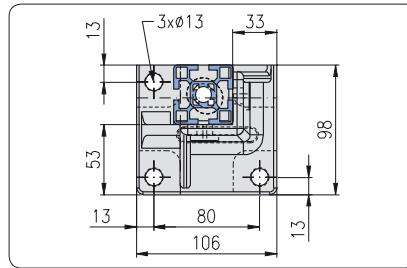
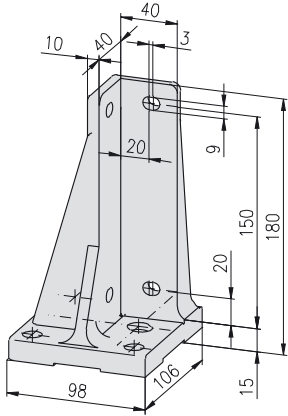

45x45, type 2, left

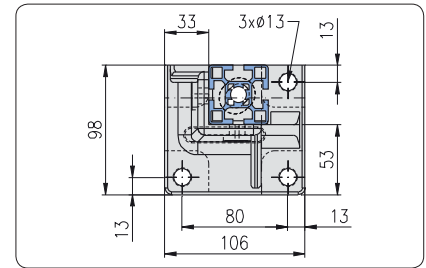

45x45, type 2, right

Comments

3D picture shows type 2, right
mirror-inverted: type 2, left

Mounting sets (→ 191, 192)

Floor mounting set 3 MKT
Profile mounting set 4 EM8

Description	for profile	Weight	Article-No.
Base foot 45x45, type 2, left	45x45	0.85 kg	1.44.84.4545.45L
Base foot 45x45, type 2, right	45x45	0.85 kg	1.44.84.4545.45R

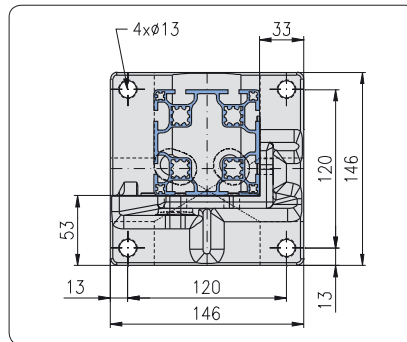
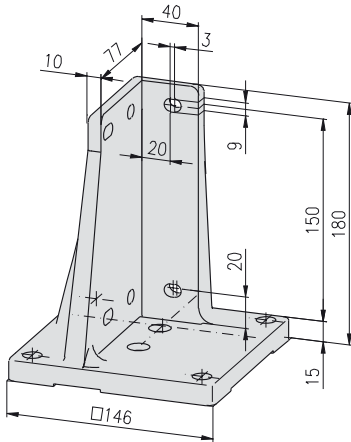

40x80, type 1, left

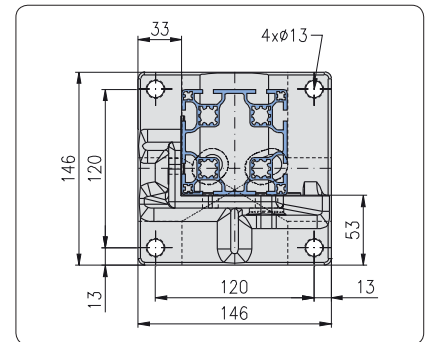

40x80, type 1, right

Comments

3D picture shows type 1, right
mirror-inverted: type 1, left

Mounting sets (→ 191, 192)

Floor mounting set 4 MKT
Profile mounting set 6 EM8

Description	for profile	Weight	Article-No.
Base foot 40x80, type 1, left	40x80, 60x80, 45x90	1.39 kg	1.44.84.4080.00L
Base foot 40x80, type 1, right	40x80, 60x80, 45x90	1.39 kg	1.44.84.4080.00R

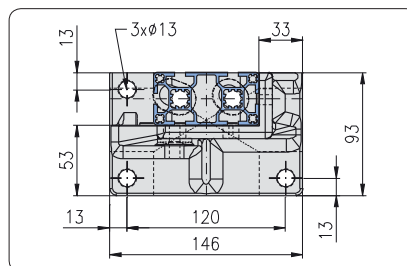
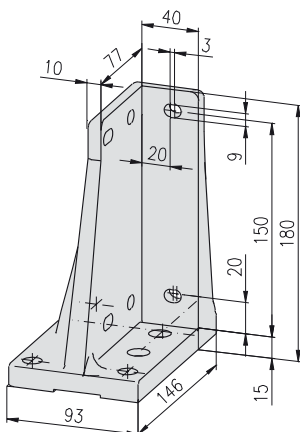

40x80, type 2, left

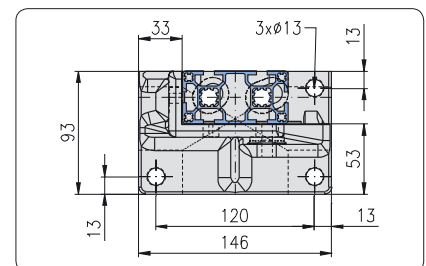

40x80, type 2, right

Comments

3D picture shows type 2, right
mirror-inverted: type 2, left

Mounting sets (→ 191, 192)

Floor mounting set 3 MKT
Profile mounting set 6 EM8

Description	for profile	Weight	Article-No.
Base foot 40x80, type 2, left	40x80	1.01 kg	1.44.84.4080.40L
Base foot 40x80, type 2, right	40x80	1.01 kg	1.44.84.4080.40R

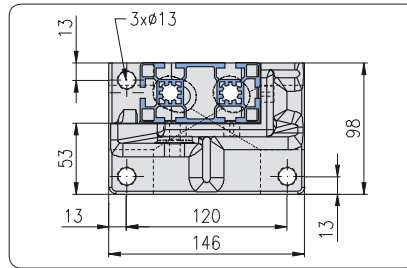
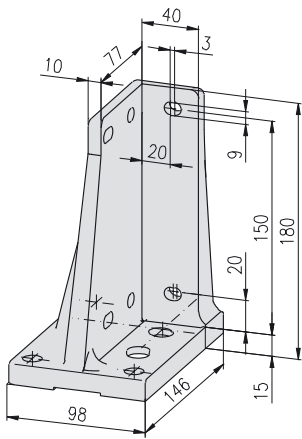

45×90, type 2, left

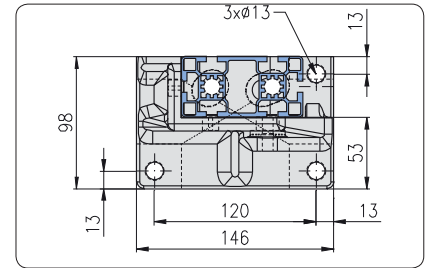

45×90, type 2, right

Comments

3D picture shows type 2, right
mirror-inverted: type 2, left

Mounting sets (↔ 191, 192)

Floor mounting set 3 MKT
Profile mounting set 6 EM8

Description	for profile	Weight	Article-No.
Base foot 45×90, type 2, left	45×90	1.10 kg	1.44.84.4590.45L
Base foot 45×90, type 2, right	45×90	1.10 kg	1.44.84.4590.45R

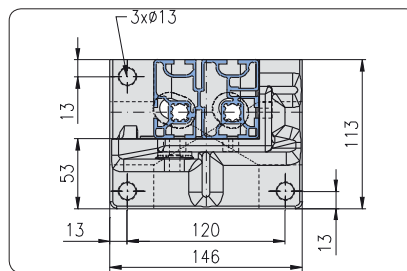
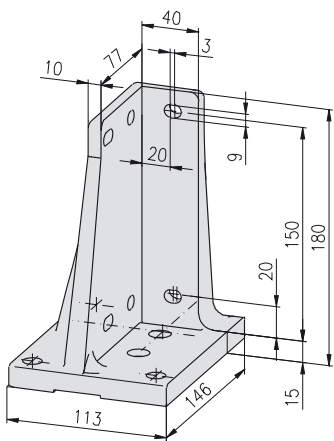

60×80, type 2, left

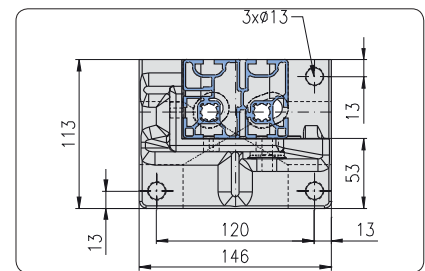

60×80, type 2, right

Comments

3D picture shows type 2, right
mirror-inverted: type 2, left

Mounting sets (↔ 191, 192)

Floor mounting set 3 MKT
Profile mounting set 6 EM8

Description	for profile	Weight	Article-No.
Base foot 60×80, type 2, left	60×80	1.25 kg	1.44.84.6080.60L
Base foot 60×80, type 2, right	60×80	1.25 kg	1.44.84.6080.60R

Floor mounting sets

Cross-reference list for base feet and floor mounting sets			
Base foot	Article-No.	Floor mounting set	
		3 MKT, 1.44.83BB	4 MKT, 1.44.84BB
40×40, type 1, le/ri	1.44.84.4040.00x		•
40×40, type 2, le/ri	1.44.84.4040.40x	•	
40×80, type 1, le/ri	1.44.84.4080.00x		•
40×80, type 2, le/ri	1.44.84.4080.40x	•	
45×45, type 2, le/ri	1.44.84.4545.45x	•	
45×90, type 2, le/ri	1.44.84.4590.45x	•	
60×80, type 2, le/ri	1.44.84.6080.60x	•	

Comments

- Drilling depth min. 70 mm
- Plain washers for vertical alignment as required

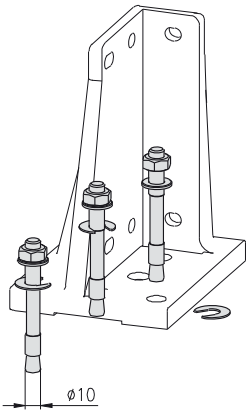

Description	Weight	Article-No.
Floor mounting set 3 MKT	202.3 g	1.44.83BB

Single parts	Pcs.	Weight	Article-No.
Pin anchor MKT, B10/20/95	3	65.3 g	0.66.MKT.B1020/95
Plain washer 1×Ø24/11	8	0.8 g	1.44.89011324

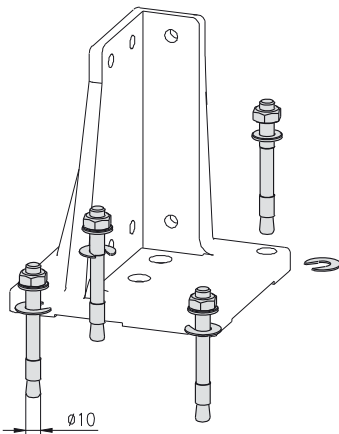

Description	Weight	Article-No.
Floor mounting set 4 MKT	269.2 g	1.44.84BB

Single parts	Pcs.	Weight	Article-No.
Pin anchor MKT, B10/20/95	4	65.3 g	0.66.MKT.B1020/95
Plain washer 1×Ø24/11	10	0.8 g	1.44.89011324

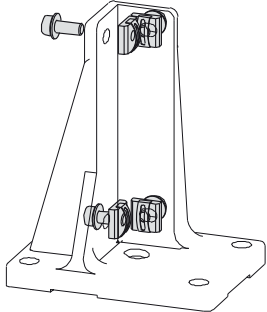
Profile mounting sets

Application

Suitable for mounting of the profiles:

- 40×40
- 45×45

Description	Weight	Article-No.
Profile mounting set 4 EM8	112.4 g	1.44.80BP40.20
Single parts	Pcs.	Weight
Threaded plate, heavy, E M8	4	16.3 g
Collar screw WN 251 M8×20	4	11.8 g

Application

Suitable for mounting of the profiles:

- 40×80
- 45×90
- 60×80, panel

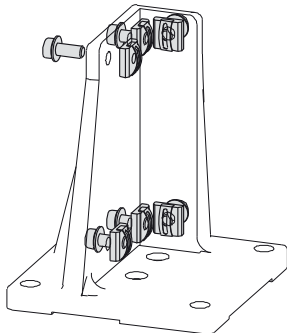

Description	Weight	Article-No.
Profile mounting set 6 EM8	168.6 g	1.44.80BP80.20
Single parts	Pcs.	Weight
Threaded plate, heavy, E M8	6	16.3 g
Collar screw WN 251 M8×20	6	11.8 g

Base angle

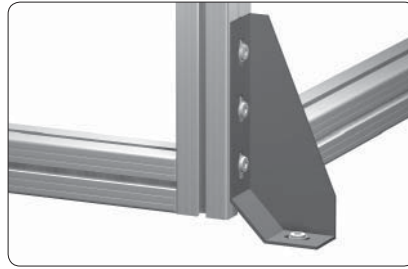

Application

For fastening of frames to floor or wall

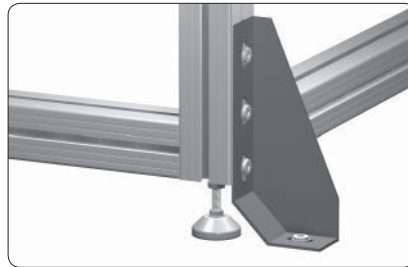

Suitable for use together with levelling feet with max. diameter 100 mm

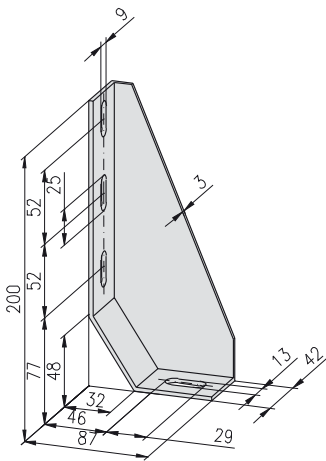

Technical data

material: sheet steel
surface: galvanised and black coated

Description

Base angle 200x87x42

Weight

413 g

Article-No.

1.44.820001

Stacking foot



Application

Element to fix 2 profiles in core hole

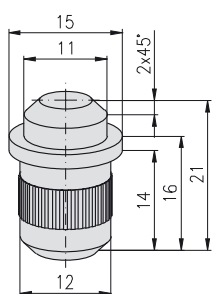
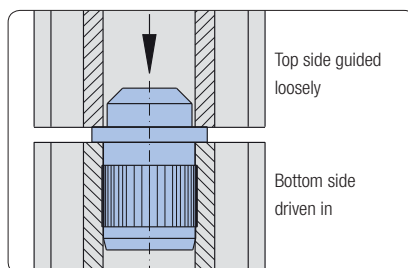

Technical data

material: steel
surface: galvanised

Description

Stacking foot

Weight

19 g

Article-No.

1.44.901221



Castors

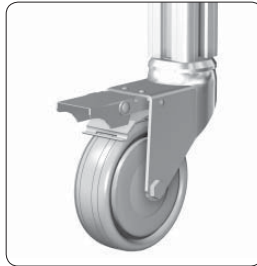

Fastening in core hole

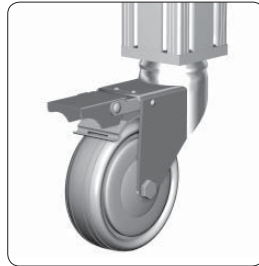

Fastening through base plate for profile without centric core hole

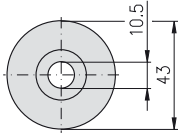
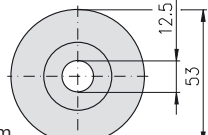
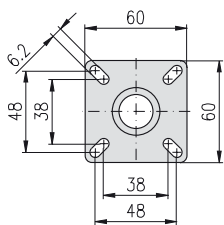
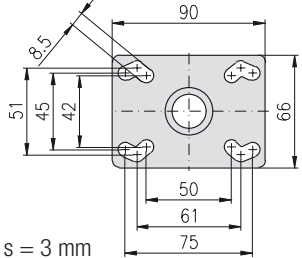

Fastening by press-fit threaded insert across the profile core hole

Variations		
Castor-Ø	50 mm / 75 mm	100 mm / 125 mm
Bolt hole type	 s = 7 mm	 s = 10.5 mm
Fitting plate type	 s = 2 mm	 s = 3 mm

Fixed castors

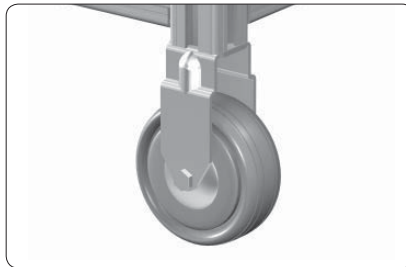

Technical data

material:

- capsule: sheet steel, galvanised
- wheels: solid rubber tyres, grey

Ø75/100/125 incl. thread protection

max. static load: F_{max}

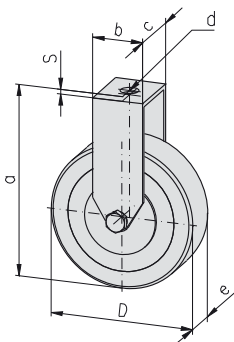

Description	D	a	Weight	Article-No.
Fixed castor with bolt hole	Ø50	69	130 g	1.45.11050
Fixed castor with bolt hole	Ø75	98	240 g	1.45.11075
Fixed castor with bolt hole	Ø100	133	500 g	1.45.11100
Fixed castor with bolt hole	Ø125	158	900 g	1.45.11125
Fixed castor with fitting plate	Ø50	71	190 g	1.45.12050
Fixed castor with fitting plate	Ø75	100	300 g	1.45.12075
Fixed castor with fitting plate	Ø100	136	610 g	1.45.12100
Fixed castor with fitting plate	Ø125	161	1,010 g	1.45.12125

Design bolt hole						
D	b	c	d	e	s	F_{max}
Ø50	30	27	Ø10.5	18	2.0	400 N
Ø75	34	27	Ø10.5	25	2.0	550 N
Ø100	57	43	Ø12.5	32	2.5	800 N
Ø125	57	43	Ø12.5	32	2.5	1,000 N

Swivel castors

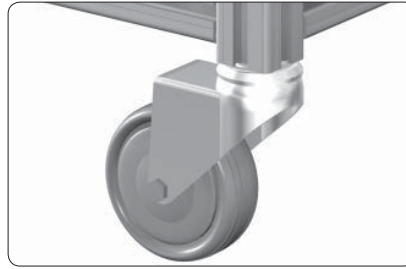

Technical data

material:

- capsule: sheet steel, galvanised
- wheels: solid rubber tyres, grey

Ø75/100/125 incl. thread protection

max. static load: F_{max}

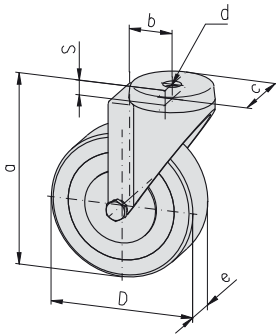

Description	D	a	Weight	Article-No.
Swivel castor with bolt hole	Ø50	69	180 g	1.45.21050
Swivel castor with bolt hole	Ø75	98	310 g	1.45.21075
Swivel castor with bolt hole	Ø100	133	680 g	1.45.21100
Swivel castor with bolt hole	Ø125	158	890 g	1.45.21125
Swivel castor with fitting plate	Ø50	71	230 g	1.45.22050
Swivel castor with fitting plate	Ø75	100	360 g	1.45.22075
Swivel castor with fitting plate	Ø100	136	780 g	1.45.22100
Swivel castor with fitting plate	Ø125	161	990 g	1.45.22125

Dimensions see table below

Swivel castors lockable

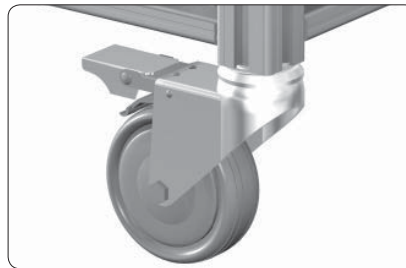

Technical data

material:

- capsule: sheet steel, galvanised
- wheels: solid rubber tyres, grey

stop fix: - wheel break
- swivel break

Ø75/100/125 incl. thread protection

max. static load: F_{max}

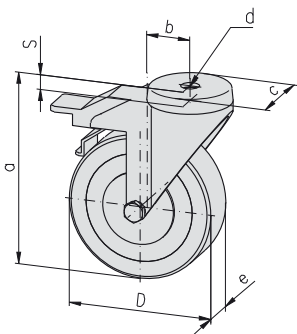

Description	D	a	Weight	Article-No.
Swivel castor, lockable with bolt hole	Ø50	69	220 g	1.45.31050
Swivel castor, lockable with bolt hole	Ø75	98	450 g	1.45.31075
Swivel castor, lockable with bolt hole	Ø100	133	840 g	1.45.31100
Swivel castor, lockable with bolt hole	Ø125	158	990 g	1.45.31125
Swivel castor, lockable with fitting plate	Ø50	71	270 g	1.45.32050
Swivel castor, lockable with fitting plate	Ø75	100	500 g	1.45.32075
Swivel castor, lockable with fitting plate	Ø100	136	940 g	1.45.32100
Swivel castor, lockable with fitting plate	Ø125	161	1,090 g	1.45.32125

Design bolt hole						
D	b	c	d	e	s	F_{max}
Ø50	25	Ø43	Ø10.5	18	10.5	400 N
Ø75	30.5	Ø43	Ø10.5	25	10.5	550 N
Ø100	43	Ø57	Ø12.5	32	10.5	800 N
Ø125	43	Ø57	Ø12.5	32	10.5	1,000 N

Locking castors

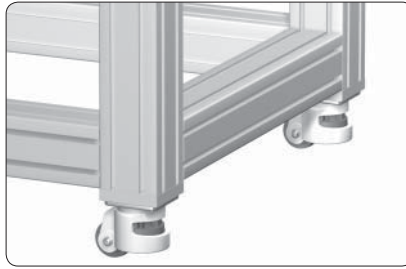

Application

Locking castors for easy movement and positioning of trolleys, benches and assemblies

Technical data

material:

- capsule: Al
- fastening elements: C45
- locking foot: GD-Al, rubber
- max. static load: F_{max}

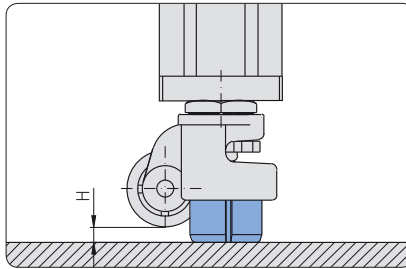

Extended support foot to secure position

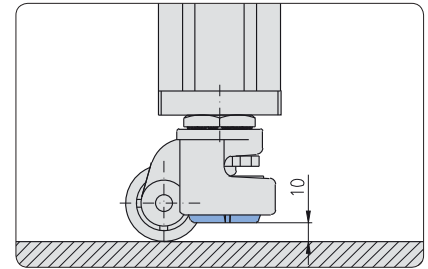

Retracted support foot for easy movement

Design					
D	a	b _{max}	c	H _{max}	F _{max}
Ø50	83	93	98	10	2,000 N
Ø62	102	117	122	15	4,000 N

Locking castors
with plate

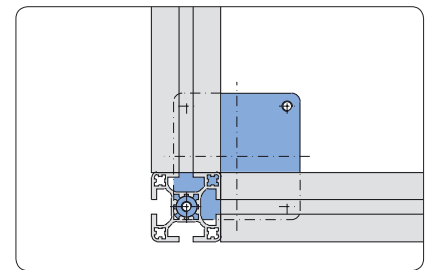
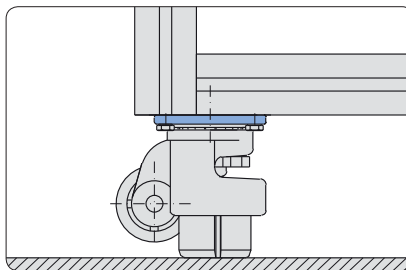

Mounting on profile frame using core hole and slot

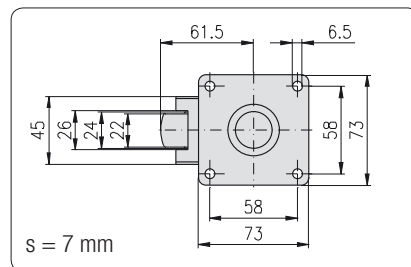

Castor-Ø50

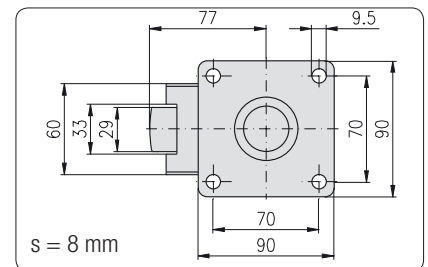

Castor-Ø62

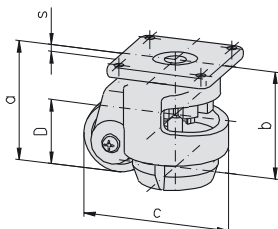

Description	D	Weight	Article-No.
Locking castor 200 kg, with plate	Ø50	760 g	1.45.80200.073
Locking castor 400 kg, with plate	Ø62	1,380 g	1.45.80400.090

Locking castors with center thread

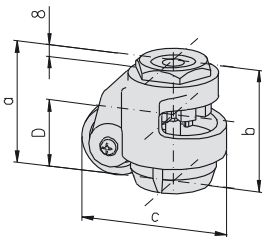
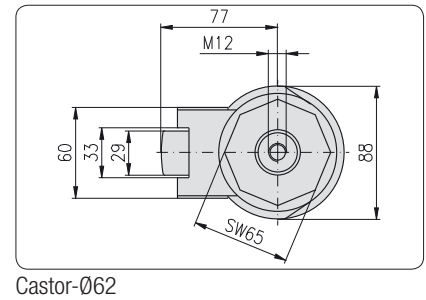
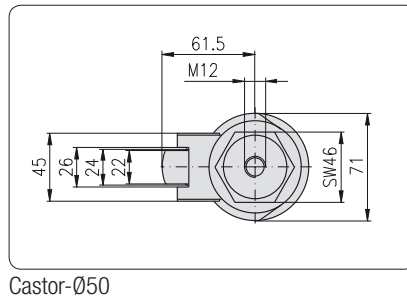
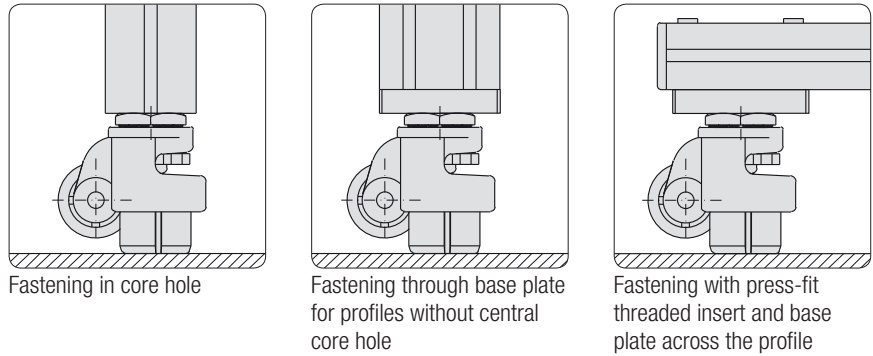

Description	D	Weight	Article-No.
Locking castor 200 kg, with center thread	Ø50	760 g	1.45.81200.046
Locking castor 400 kg, with center thread	Ø62	1,380 g	1.45.81400.065

Threaded bolt for locking castor with center thread

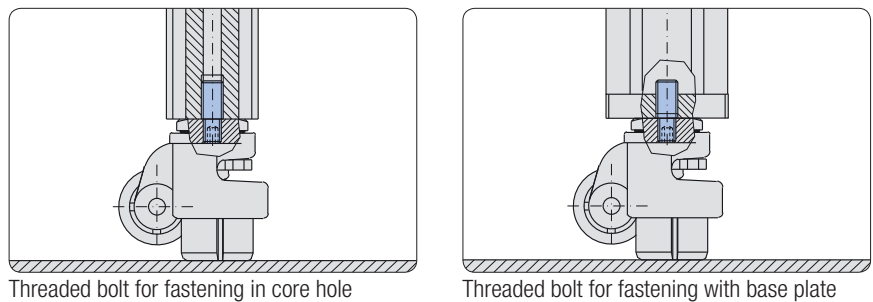

Application
 For fastening of locking castors with central thread

- in core hole-Ø12 of the profile
- on base plate

Technical data
 material: steel
 surface: galvanised

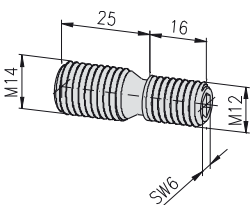

Description	Weight	Article-No.
Threaded bolt M12/M14	21 g	1.45.81000.M12M14

Angles 25×40

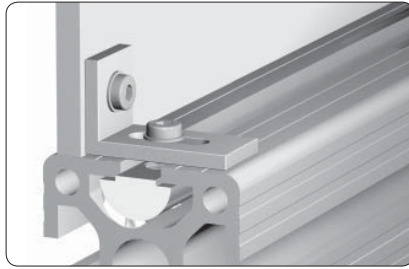

Fastening of panels

Application

Angle bracket for the mounting of panels, table tops, switches and accessories

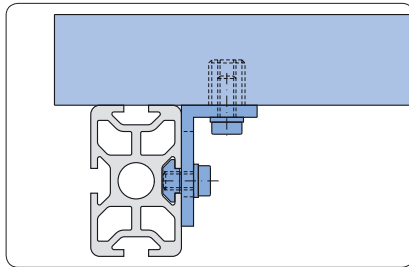

Fastening of table tops

Technical data

material: aluminium
 strength: F22
 surface: natural anodised

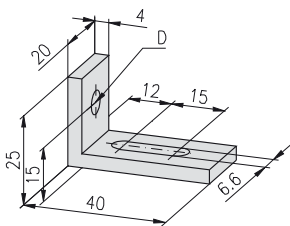

Comments

Design with clearance hole drilling

Description	D	Weight	Article-No.
Angle 25×40	Ø6.6	11 g	1.46.110
Angle 25×40	Ø8.7	10 g	1.46.115

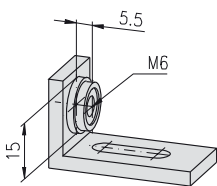

Comments

Design with nut M6 ± 0.5 mm floating in cage

Description	Weight	Article-No.
Angle 25×40, M6	15 g	1.46.120

Angles PA

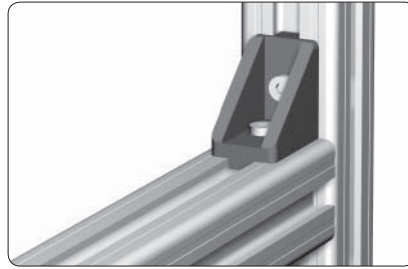

Support of free-standing profiles

Application

For supporting of profiles and mounting of cover panels

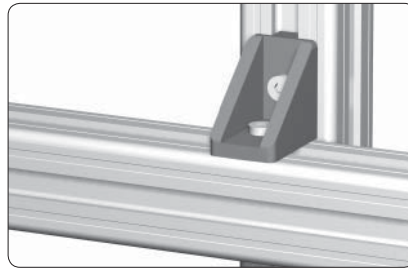

Support across the profile
In this application the rotary lock must be removed from one side

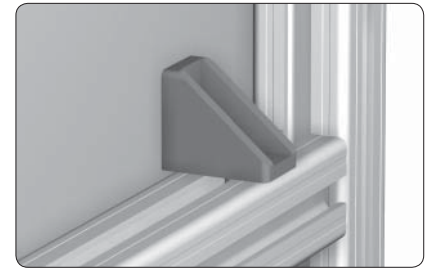

Mounting of cover panels
In this application the rotary lock must be removed from both sides

Technical data

material: PA-GF

20×28

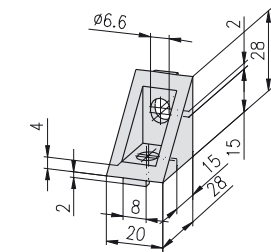

Description	Colour	Weight	Article-No.
Angle PA, 20×28	grey	6.4 g	1.46.203.2028.1
Angle PA, 20×28	black	6.4 g	1.46.203.2028.2

30×38

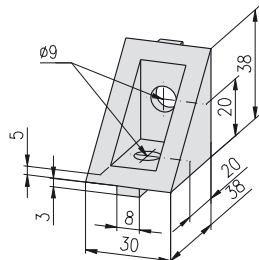

Description	Colour	Weight	Article-No.
Angle PA, 30×38	grey	18.9 g	1.46.203.3038.1
Angle PA, 30×38	black	18.9 g	1.46.203.3038.2

Angles GD-Zn

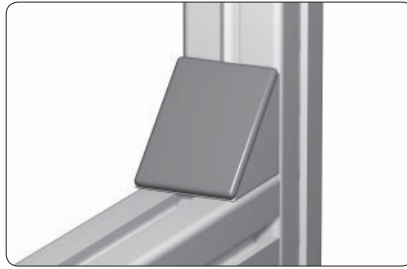

Application

For supporting profiles and mounting various machine components

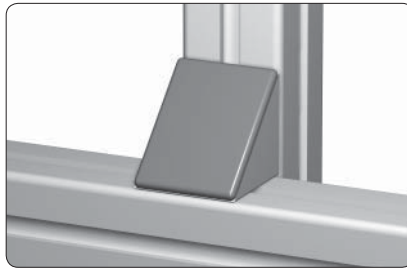

Technical data

material:

- angle: GD-Zn
- cover cap: PA-GK 30
- T-slot nut: steel, galvanised
- screw: steel, galvanised
- surface: natural or aluminium coloured powder-coated

For mounting cross to the slot the noses can be broken off

17×20

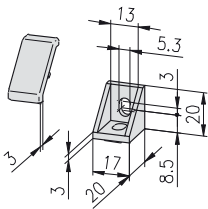

Description	Surface	Weight	Article-No.
Angle GD-Zn, 17×20	natural	13.7 g	1.46.204.1720.1
Angle GD-Zn, 17×20	powder-coated	13.7 g	1.46.204.1720.2
Cover cap for angle GD-Zn, 17×20		1.7 g	1.46.204.1720A
Angle connection set	1720 H/H	20.9 g	1.46.204.1720.□HH
Angle connection set	1720 H/F	23.6 g	1.46.204.1720.□HF
Angle connection set	1720 F/F	26.3 g	1.46.204.1720.□FF
Angle connection set	1720 T H/F	25.0 g	1.46.204.1720T□HF
Angle connection set	1720 T F/F	29.1 g	1.46.204.1720T□FF



Single parts: Angle connection sets 1720					
Angle	Slot	Fastening elements			
	H	threaded plate		lens head screw	Pcs.
	F	T-slot nut			
1.46.204.1720.□	H	H	1.31.4HM5	0.63.WN7381.05006	2
1.46.204.1720.□	H	H	1.31.4HM5	0.63.WN7381.05006	1
		F	1.34.10FM5	0.63.WN7381.05008	1
1.46.204.1720.□	F	F	1.34.10FM5	0.63.WN7381.05008	2

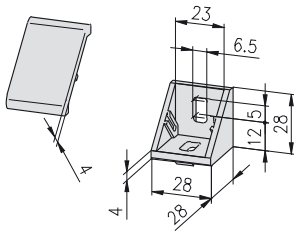

Single parts: Angle connection sets 1720 T					
Angle	Slot	Fastening elements			
	H	threaded plate		lens head screw	Pcs.
	F	T-nut for subs. insertion			
1.46.204.1720□	H	H	1.31.4HM5	0.63.WN7381.05006	1
		F	1.32.4FM5	0.63.WN7381.05008	1
1.46.204.1720□	F	F	1.32.4FM5	0.63.WN7381.05008	2

-
- 1 angle natural
- 2 angle powder-coated

28×28

Description	Surface	Weight	Article-No.
Angle GD-Zn, 28×28	natural	39.6 g	1.46.204.2828.1
Angle GD-Zn, 28×28	powder-coated	39.6 g	1.46.204.2828.2
Cover cap for angle GD-Zn, 28×28		5.6 g	1.46.204.2828A
Angle connection set	2828 F/F	56.4 g	1.46.204.2828.□FF
Angle connection set	2828 F/E	56.8 g	1.46.204.2828.□FE
Angle connection set	2828 E/E	57.2 g	1.46.204.2828.□EE
Angle connection set	2828 T F/F	59.8 g	1.46.204.2828T□FF
Angle connection set	2828 T F/E	66.3 g	1.46.204.2828T□FE
Angle connection set	2828 T E/E	72.8 g	1.46.204.2828T□EE

Single parts: Angle connection sets 2828						
Angle	Slot	Fastening elements				
		T-slot nut		lens head screw		Pcs.
1.46.204.2828.□	F F	1.34.10FM6		0.63.WN7381.06010		2
1.46.204.2828.□	F E	1.34.10FM6		0.63.WN7381.06010		1
		1.34.10EM6		0.63.WN7381.06012		1
1.46.204.2828.□	E E	1.34.10EM6		0.63.WN7381.06012		2

Single parts: Angle connection sets 2828 T						
Angle	Slot	Fastening elements				
		T-nut for subs. insertion		lens head screw		Pcs.
1.46.204.2828□	F F	1.32.4FM6		0.63.WN7381.06010		2
1.46.204.2828□	F E	1.32.4FM6		0.63.WN7381.06010		1
		1.32.4EM6		0.63.WN7381.06012		1
1.46.204.2828□	E E	1.32.4EM6		0.63.WN7381.06012		2

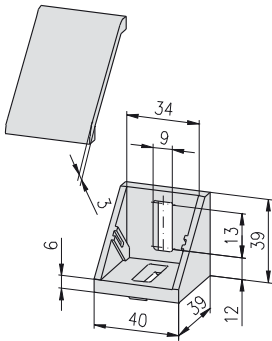

- 1 angle natural
 2 angle powder-coated

40×39





Description	Surface	Weight	Article-No.
Angle GD-Zn, 40×39	natural	85.5 g	1.46.204.4039.1
Angle GD-Zn, 40×39	powder-coated	85.5 g	1.46.204.4039.2
Cover cap for angle GD-Zn, 40×39		8.0 g	1.46.204.4039A
Angle connection set	4039 F/F	105.9 g	1.46.204.4039.□FF
Angle connection set	4039 F/E	111.9 g	1.46.204.4039.□FE
Angle connection set	4039 E/E	117.9 g	1.46.204.4039.□EE
Angle connection set	4039 T F/F	105.9 g	1.46.204.4039T□FF
Angle connection set	4039 T F/E	111.9 g	1.46.204.4039T□FE
Angle connection set	4039 T E/E	117.9 g	1.46.204.4039T□EE

Single parts: Angle connection sets 4039

Angle	Slot	Fastening elements			
		T-screw		hexagon flange nut	Pcs.
1) 1.46.204.4039.□	F F	1.34.FM82		0.61.D06923.08	2
1.46.204.4039.□	F E	1.34.FM82		0.61.D06923.08	1
	E E	1.34.EM82		0.61.D06923.08	1
1.46.204.4039.□	E E	1.34.EM82		0.61.D06923.08	2

Single parts: Angle connection sets 4039 T

Angle	Slot	Fastening elements			
		T-nut for subs. insertion		lens head screw	Pcs.
1.46.204.4039□	F F	1.32.4FM8		0.63.WN7381.08012	2
1.46.204.4039□	F E	1.32.4FM8		0.63.WN7381.08012	1
	E E	1.32.4EM8		0.63.WN7381.08016	1
1.46.204.4039□	E E	1.32.4EM8		0.63.WN7381.08016	2

- 1 angle natural
 2 angle powder-coated

- 1) Connection with T-screw only without cover cap

38×76

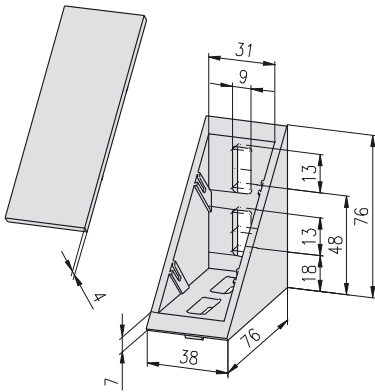

Description	Surface	Weight	Article-No.
Angle GD-Zn, 38×76	natural	273.0 g	1.46.204.3876.1
Angle GD-Zn, 38×76	powder-coated	273.0 g	1.46.204.3876.2
Cover cap for angle GD-Zn, 38×76		16.8 g	1.46.204.3876A
Angle connection set	3876 F/F	334.2 g	1.46.204.3876.□FF
Angle connection set	3876 F/E	342.2 g	1.46.204.3876.□FE
Angle connection set	3876 E/E	350.2 g	1.46.204.3876.□EE
Angle connection set	3876 T F/F	313.8 g	1.46.204.3876T□FF
Angle connection set	3876 T F/E	325.8 g	1.46.204.3876T□FE
Angle connection set	3876 T E/E	337.8 g	1.46.204.3876T□EE

Single parts: Angle connection sets 3876					
Angle	Slot	Fastening elements			
		T-screw		hexagon flange nut	Pcs.
1.46.204.3876.□	F F	1.34.FM82	0.61.D06923.08		4
1.46.204.3876.□	F E	1.34.FM82	0.61.D06923.08		2
		1.34.EM82	0.61.D06923.08		2
1.46.204.3876.□	E E	1.34.EM82	0.61.D06923.08		4





Single parts: Angle connection sets 3876 T					
Angle	Slot	Fastening elements			
		T-nut for subs. insertion		lens head screw	Pcs.
1.46.204.3876□	F F	1.32.4FM8	0.63.WN7381.08012		4
1.46.204.3876□	F E	1.32.4FM8	0.63.WN7381.08012		2
		1.32.4EM8	0.63.WN7381.08016		2
1.46.204.3876□	E E	1.32.4EM8	0.63.WN7381.08016		4

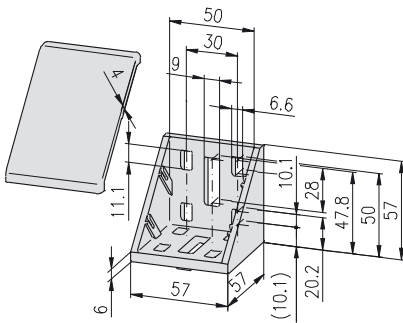

-
- 1 angle natural
- 2 angle powder-coated

57×57



Description	Surface	Weight	Article-No.
Angle GD-Zn, 57×57	natural	226.3 g	1.46.204.5757.1
Angle GD-Zn, 57×57	powder-coated	226.3 g	1.46.204.5757.2
Cover cap for angle GD-Zn, 57×57		22.8 g	1.46.204.5757A
Angle connection set	5757 F/F	296.7 g	1.46.204.5757.□FF
Angle connection set	5757 F/E	280.8 g	1.46.204.5757.□FE
Angle connection set	5757 E/E	261.9 g	1.46.204.5757.□EE
Angle connection set	5757 T F/F	246.7 g	1.46.204.5757T□FF
Angle connection set	5757 T F/E	252.7 g	1.46.204.5757T□FE
Angle connection set	5757 T E/E	258.7 g	1.46.204.5757T□EE

Single parts: Angle connection sets 5757						
Angle	Slot	Fastening elements				
	F	T-slot nut		lens head screw		Pcs.
	E	T-screw		hexagon flange nut		
1.46.204.5757.□	F	F	1.34.10FM6	0.63.WN7381.06012	8	
1.46.204.5757.□	F	F	1.34.10FM6	0.63.WN7381.06012	4	
		E	1.34.EM82	0.61.D06923.08	1	
1.46.204.5757.□	E	E	1.34.EM82	0.61.D06923.08	2	



Single parts: Angle connection sets 5757 T						
Angle	Slot	Fastening elements				
		T-nut for subs. insertion		lens head screw		Pcs.
1.46.204.5757□	F	F	1.32.4FM6	0.63.WN7381.06012	8	
1.46.204.5757□	F	F	1.32.4FM6	0.63.WN7381.06012	4	
		E	1.32.4EM8	0.63.WN7381.08016	1	
1.46.204.5757□	E	E	1.32.4EM8	0.63.WN7381.08016	2	

-
- 1 angle natural
- 2 angle powder-coated

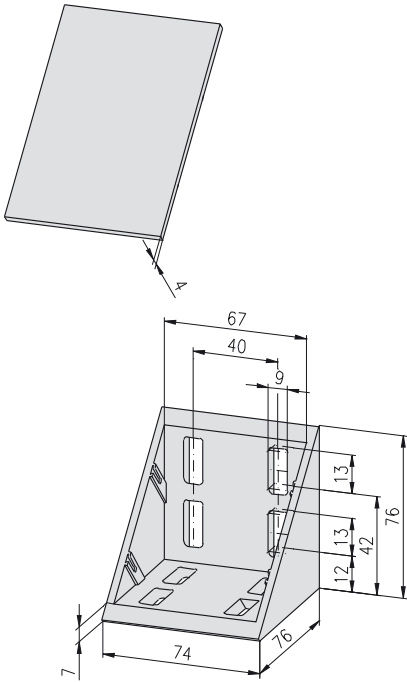
74×76

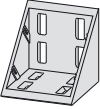

Description	Surface	Weight	Article-No.
Angle GD-Zn, 74×76	natural	434.5 g	1.46.204.7476.1
Angle GD-Zn, 74×76	powder-coated	434.5 g	1.46.204.7476.2
Cover cap for angle GD-Zn, 74×76		32.7 g	1.46.204.7476A
Angle connection set	7476 E/E	588.9 g	1.46.204.7476.□EE

Single parts: Angle connection set 7476				
Angle	Slot	Fastening elements		Pcs.
		T-screw 	hexagon flange nut 	
1.46.204.7476.□	E E	1.34.EM82	0.61.D06923.08	8

-
- 1 angle natural
- 2 angle powder-coated

Angles GD-AI

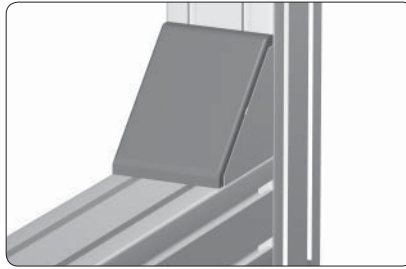

Application

For supporting profiles and mounting various machine components

Technical data

material:

- angle: GD-AI
 - cover cap: PA GK 30
 - nut: steel, galvanised
 - screw: steel, galvanised
- surface: natural

42×42

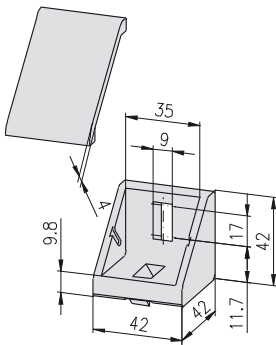

Description	Surface	Weight	Article-No.
Angle GD-AI, 42×42	natural	56.0 g	1.46.204.4242.1AL
Cover cap for angle GD-AI, 42×42		14.0 g	1.46.204.4242.AAL
Angle connection set	4242 E/E	100.0 g	1.46.204.4242.SAL

Single parts: Angle connection set 4242					
Angle	Slot	Fastening elements			Pcs.
		T-screw		hexagon flange nut	
1.46.204.4242.1AL	E E	1.34.EM825		0.61.D06923.08	2

88×86

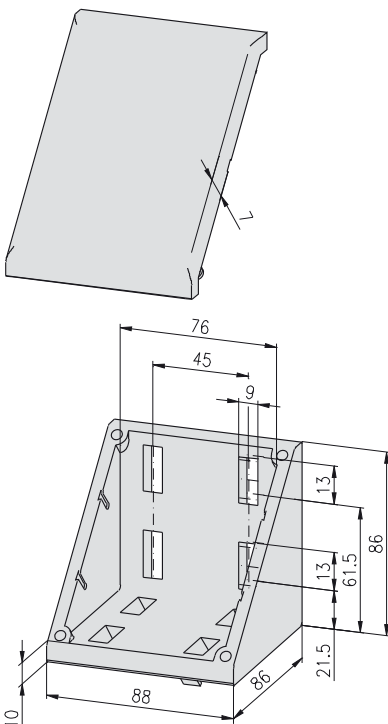

Description	Surface	Weight	Article-No.
Angle GD-AI, 88×86	natural	333.8 g	1.46.204.8886.1AL
Cover cap for angle GD-AI, 88×86		30.0 g	1.46.204.8886.AAL
Angle connection set	8886 E/E	485.5 g	1.46.204.8886.SAL

Single parts: Angle connection set 8886					
Angle	Slot	Fastening elements			Pcs.
		T-screw		hexagon flange nut	
1.46.204.8886.1AL	E E	1.34.EM825		0.61.D06923.08	8

Angles Alu



Mounting of cover panels

Application

For supporting of profiles and mounting of cover panels



Support across the profile

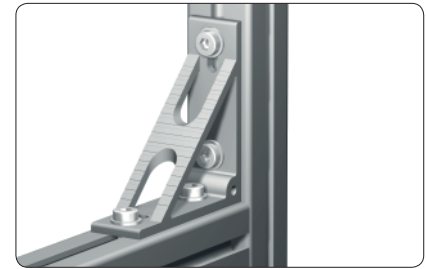

Support of free-standing profiles

Technical data

material: aluminium
 strength: F22
 surface: natural anodised

Comments

raw finish on request

48×48

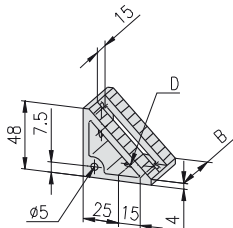

Description	D	B	Weight	Article-No.
Angle 48×48	Ø6.6	30	40 g	1.46.20536
Angle 48×48	Ø9.0	30	38 g	1.46.20539
Angle 48×48	Ø6.6	45	66 g	1.46.20546
Angle 48×48	Ø9.0	45	64 g	1.46.20549

60×60

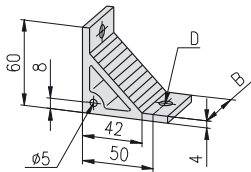

Description	D	B	Weight	Article-No.
Angle 60×60	Ø9.0	30	49 g	1.46.20639
Angle 60×60	Ø9.0	45	74 g	1.46.20649

97×97

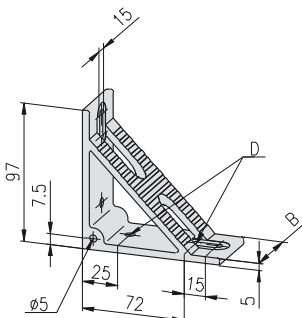

Description	D	B	Weight	Article-No.
Angle 97×97	Ø6.6	30	95 g	1.46.21036
Angle 97×97	Ø9.0	30	93 g	1.46.21039
Angle 97×97	Ø6.6	45	155 g	1.46.21046
Angle 97×97	Ø9.0	45	153 g	1.46.21049

Swivel angles

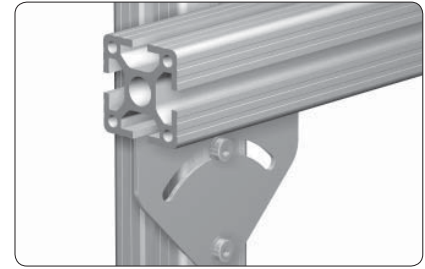
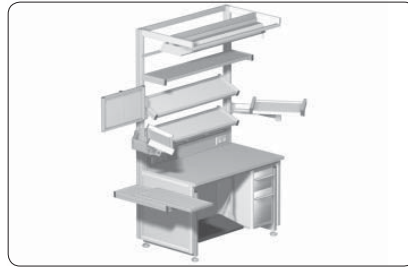

Fastening from below



Fastening from the side

Application

Infinitely variable adjusting of inclination with swivel angle

Technical data

Design alu:

- material: aluminium
- strength: F22
- surface: natural anodised

Design steel:

- material: steel
- surface: galvanised

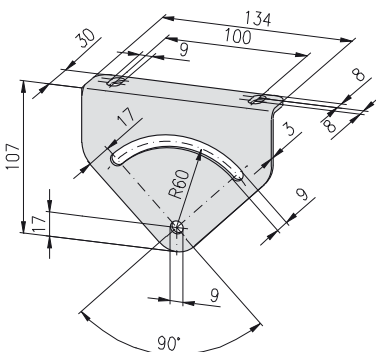
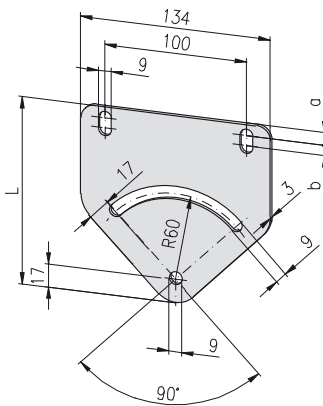

Description	L	Design	a	b	Weight	Article-No.
Swivel angle	131	alu	8	8.0	105 g	1.46.3013100.AL
Swivel angle	146	alu	13	10.5	116 g	1.46.3014600.AL
Swivel angle	131	steel	8	8.0	320 g	1.46.3013100.ST
Swivel angle	146	steel	13	10.5	360 g	1.46.3014600.ST

Description	Design	Weight	Article-No.
Swivel angle 30	alu	105 g	1.46.3110530.AL
Swivel angle 30	steel	320 g	1.46.3110530.ST

16 20 30 40 45 50 60

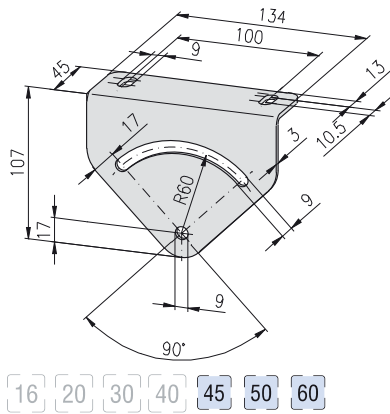

Description	Design	Weight	Article-No.
Swivel angle 45	alu	116 g	1.46.3110545.AL
Swivel angle 45	steel	360 g	1.46.3110545.ST

Cross connection plates

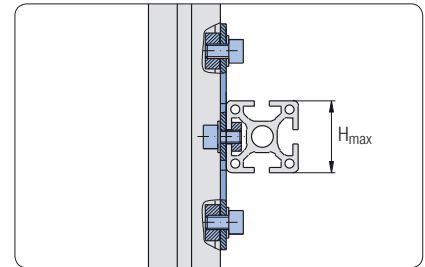
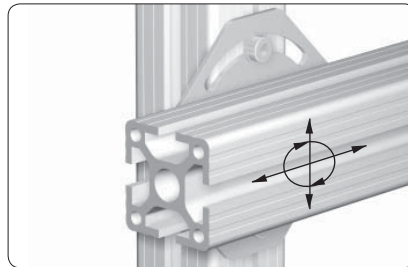

Application

The cross connection plate allows profile adjustment in 2 directions and at an angle of $\pm 45^\circ$

Technical data

material: aluminium
 strength: F22
 surface: natural anodised

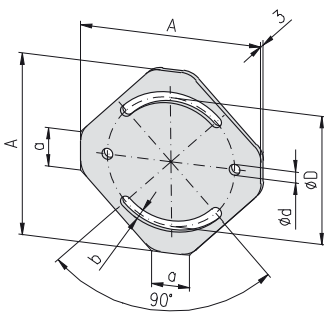

Description

Description	H _{max}	Weight	Article-No.
Cross connection plate 65×65	20	20 g	1.47.1065
Cross connection plate 85×85	30	35 g	1.47.1085
Cross connection plate 95×95	30	45 g	1.47.1095
Cross connection plate 125×125	50	80 g	1.47.1125

Type	A	a	b	ØD	Ød
65×65	65	18	5.1	45	5.1
85×85	85	18	5.1	60	5.1
95×95	95	18	6.1	65	6.1
125×125	125	37	8.1	95	8.1

Base plates

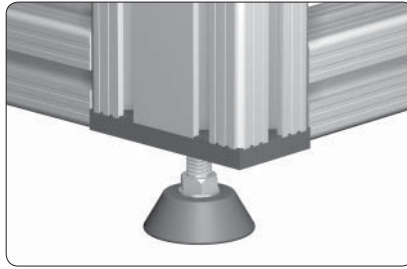

Fastening of levelling feet

Application

Base and transporting plate for profiles without centric core hole



Fastening of castors

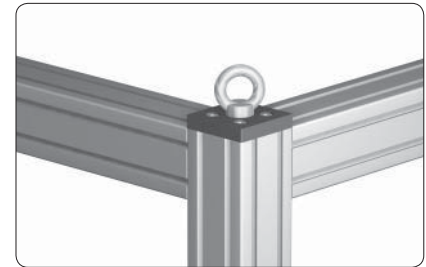

Fastening of eye-bolts

Technical data

Design Alu:

- material: aluminium
- strength: F22
- surface: black powder-coated

Design GD-Zn:

- material: GD-Zn
- surface: black powder-coated

Accessories

- threaded insert
- cap-screw DIN 912

Comments

Counterbore DIN 74 for cap-screw DIN 912

Variants

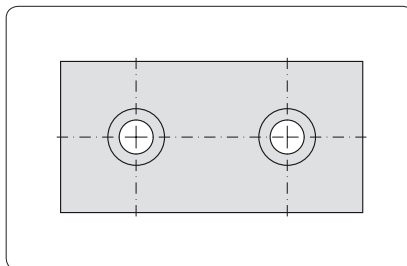

without thread

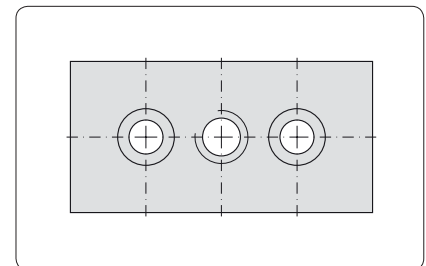

with thread

Dimensions	without thread			with thread M14		
	B×L	Design	h	Article-No.	Design	h
30×60	Alu	15	1.47.2030060.0600.1	GD-Zn	12	1.47.20306
40×80	Alu	15	1.47.2040080.0800.1	GD-Zn	16	1.47.20408
45×90	Alu	15	1.47.2045090.0800.1	GD-Zn	16	1.47.2045090
50×100	Alu	15	1.47.2050100.0800.1	GD-Zn	16	1.47.20510
60×90	Alu	15	1.47.2060090.0800.1	Alu	15	1.47.2060090
50×150	Alu	15	1.47.2050150.0800.1			
60×60	Alu	15	1.47.2060060.0800.1	GD-Zn	12	1.47.2060060
80×80	Alu	15	1.47.2080080.0800.1	GD-Zn	16	1.47.20808
90×90	Alu	15	1.47.2090090.0800.1	GD-Zn	16	1.47.2090090
100×100	Alu	15	1.47.2100100.0800.1	GD-Zn	16	1.47.21010

Base plates
without thread

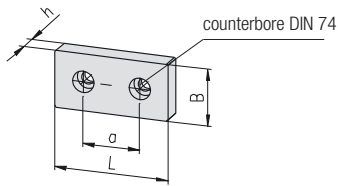

16 20 30 40 45 50 60

Description	B×L	Design	DIN 74	h	a	Weight	Article-No.
Base plate w/o thread	30×60	Alu	- Km6	15	30	64 g	1.47.2030060.0600.1
Base plate w/o thread	40×80	Alu	- Km8	15	40	114 g	1.47.2040080.0800.1
Base plate w/o thread	45×90	Alu	- Km8	15	45	148 g	1.47.2045090.0800.1
Base plate w/o thread	50×100	Alu	- Km8	15	50	186 g	1.47.2050100.0800.1
Base plate w/o thread	60×90	Alu	- Km8	15	45	202 g	1.47.2060090.0800.1

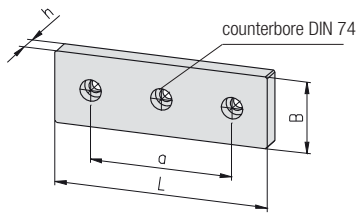

16 20 30 40 45 50 60

Description	B×L	Design	DIN 74	h	a	Weight	Article-No.
Base plate w/o thread	50×150	Alu	- Km8	15	100	280 g	1.47.2050150.0800.1

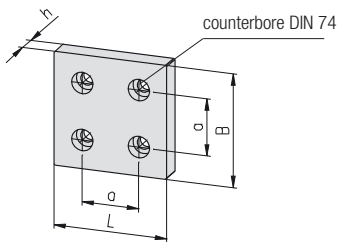

16 20 30 40 45 50 60

Description	B×L	Design	DIN 74	h	a	Weight	Article-No.
Base plate w/o thread	60×60	Alu	- Km8	15	30	115 g	1.47.2060060.0800.1
Base plate w/o thread	80×80	Alu	- Km8	15	40	228 g	1.47.2080080.0800.1
Base plate w/o thread	90×90	Alu	- Km8	15	45	297 g	1.47.2090090.0800.1
Base plate w/o thread	100×100	Alu	- Km8	15	50	374 g	1.47.2100100.0800.1

Base plates
with thread

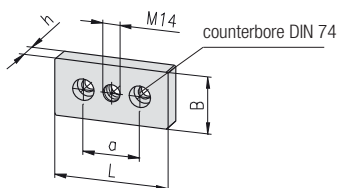

16 20 30 40 45 50 60

Description	B×L	Design		h	a	Weight	Article-No.
Base plate	30×60	GD-Zn	M14 M6	12	30	104.2 g	1.47.20306
Base plate	40×80	GD-Zn	M14 M8	16	40	205.2 g	1.47.20408
Base plate	45×90	GD-Zn	M14 M8	16	45	256.5 g	1.47.2045090
Base plate	50×100	GD-Zn	M14 M8	16	50	316.8 g	1.47.20510
Base plate	60×90	Alu	M14 M8	15	45	197.1 g	1.47.2060090

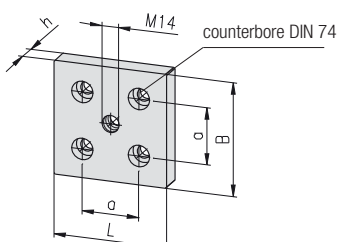

16 20 30 40 45 50 60

Description	B×L	Design		h	a	Weight	Article-No.
Base plate	60×60	GD-Zn	M14 M8	12	30	158.4 g	1.47.2060060
Base plate	80×80	GD-Zn	M14 M8	16	40	434.3 g	1.47.20808
Base plate	90×90	GD-Zn	M14 M8	16	45	520.7 g	1.47.2090090
Base plate	100×100	GD-Zn	M14 M8	16	50	601.0 g	1.47.21010

Floor mounting plate

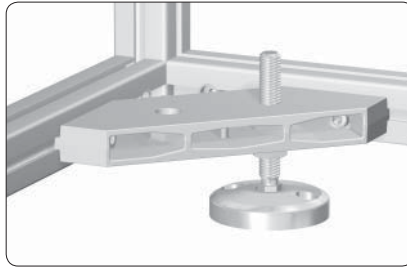

Application

For fastening and manual levelling of profile racks and frames

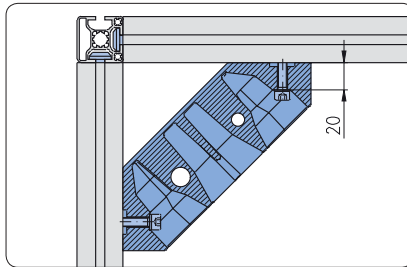

Technical data

material: aluminium
 surface: natural or black powder-coated

Fastening elements

- F-slot: 2×T-nut with leaf spring FM8 1.32.FM8
 2×cap screw M8×25
- E-slot: 2×threaded plate, heavy EM8 1.31.6EM8
 2×cap screw M8×30

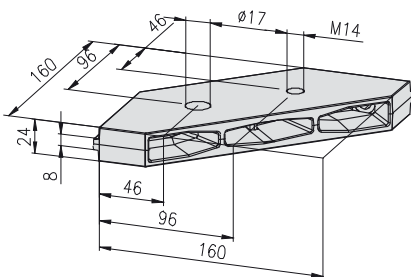

Description

Description	Weight	Article-No.
Floor mounting plate, natural	622 g	1.47.225160.1
Floor mounting plate, black powder-coated	622 g	1.47.225160.2

Mounting plates

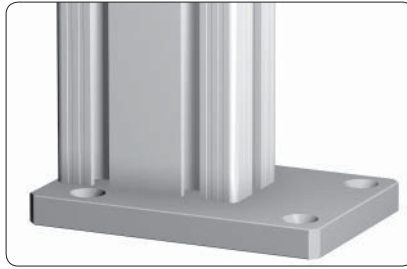

Application

Mounting plate for fixing on walls, table tops and machine frames

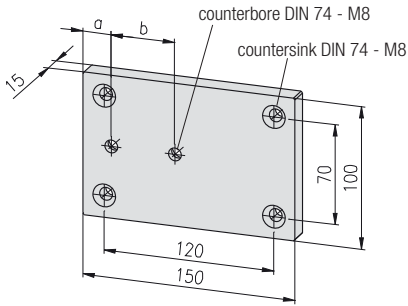

Technical data

material: aluminium
strength: F22
surface: natural anodised

Comments

Counterbore DIN 74 - M8 for cap-screw DIN 912 - M8
Countersink DIN 74 - M8 for countersunk screw DIN 7991 - M8

- 16
- 20
- 30
- 40
- 45
- 50
- 60

Description

	a	b	Weight	Article-No.
Mounting plate for profile 30×60	15	30	450 g	1.47.30306
Mounting plate for profile 40×80	20	40	450 g	1.47.30408
Mounting plate for profile 50×100	25	50	450 g	1.47.30510

Floor plate



Application

For fastening and adjusting of vertical profiles to floor and wall

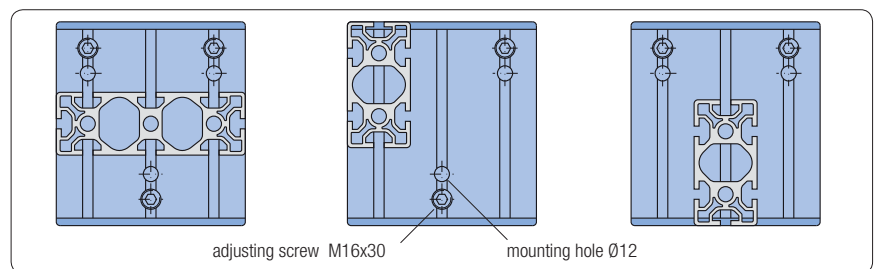

Fastening variants

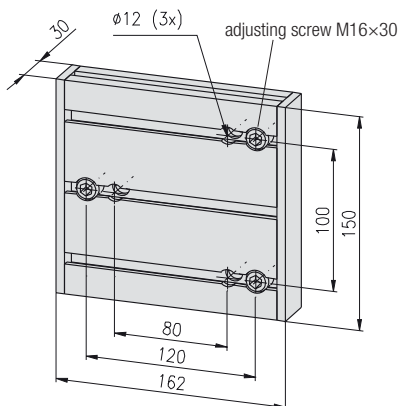

Technical data

aluminium profile: anodised
cover caps: PA-GF black

Delivery unit:

- 1 profile 30×150×150
- 2 cover caps
- 3 set screws M16×30

- 16
- 20
- 30
- 40
- 45
- 50
- 60

Description

	Weight	Article-No.
Floor plate 30×150×150	1,100 g	1.47.40315

Connection plates



Flush connection of 2 profiles without gap

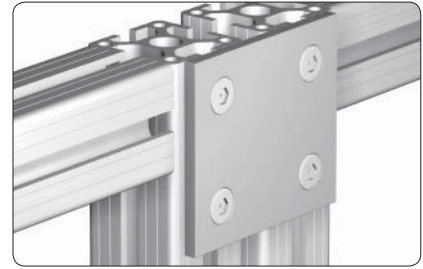

Connection of 2 profiles with gap

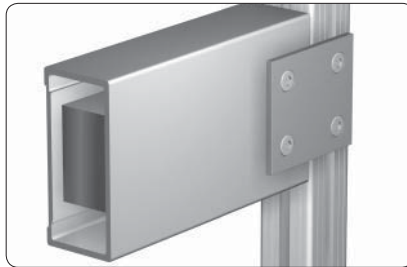

Fastening of the electrical trunking

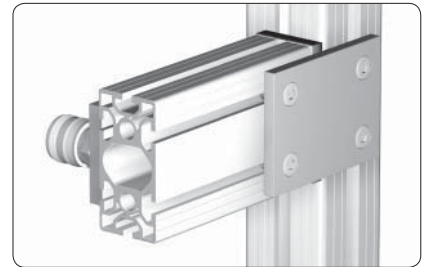

Connection of the pneumatic air manifold

Application

- for subsequent or additional connection of profiles
- for fastening of accessories

Technical data

material: aluminium
 strength: F22
 surface: natural anodised

Comments

Countersink DIN 74 - M6 / M8 for
 countersunk screw DIN 7991 - M6 / M8

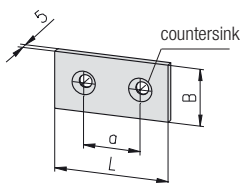

- 16 20 30 40 45 50 60

Description	B×L	Countersink	a	Weight	Article-No.
Connection plate	30×60	DIN 74 - M6	30	28 g	1.47.50306
Connection plate	40×80	DIN 74 - M8	40	38 g	1.47.50408
Connection plate	45×90	DIN 74 - M8	45	45 g	1.47.50459

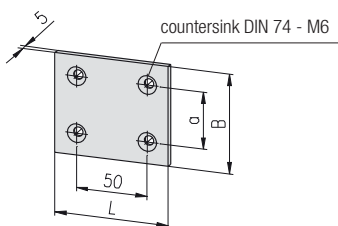

- 16 20 30 40 45 50 60

Comments

Countersink DIN 74 - M6 for
 countersunk screw DIN 7991 - M6

Description	B×L	a	Weight	Article-No.
Connection plate	50×80	30	50 g	1.47.50508
Connection plate	70×80	40	69 g	1.47.50708
Connection plate	75×80	45	76 g	1.47.50758
Connection plate	80×80	50	81 g	1.47.50808

Fastening plate
30×150

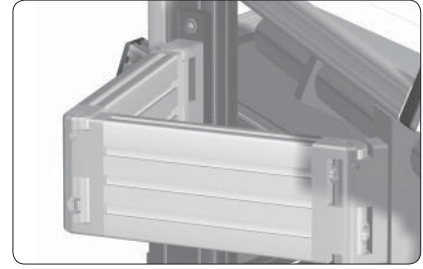

Fastening of profile 30×100

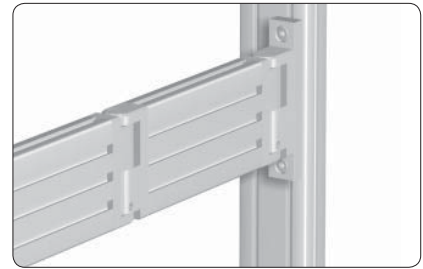

Fastening of profile 30×100 with joint 30×100

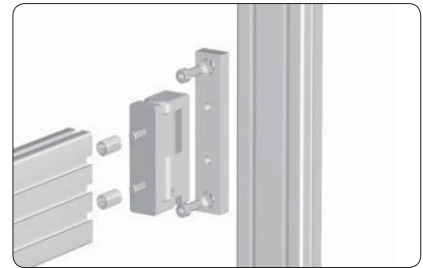
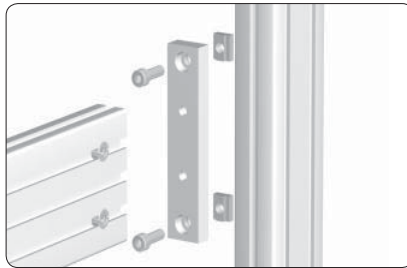

Application

Fastening plate to increase the carrying capacity of detached bracket or swivel arm

- for profile 30×100
- for joint 30×100

Technical data

material: aluminium
strength: F22
surface: natural anodised

max. bend-load: $M_b = F \times L$	
vertical profiles	M_b
30×30	750 Nm
40×40	1,000 Nm
50×50	1,500 Nm

Comments

Counterbore DIN 74 - M8
cap-screw DIN 6912 - M8

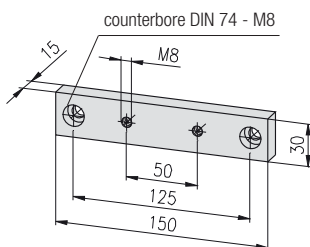

- 16 20 **30** 40 45 50 60

Description

Fastening plate 30×150

Weight

228 g

Article-No.

1.47.60315

Eye-bolt

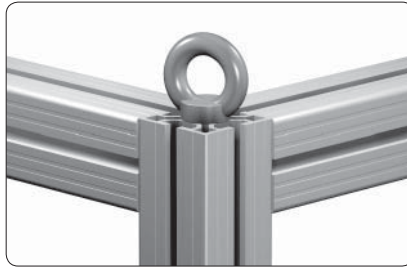

Mounting directly in the profile (core hole)

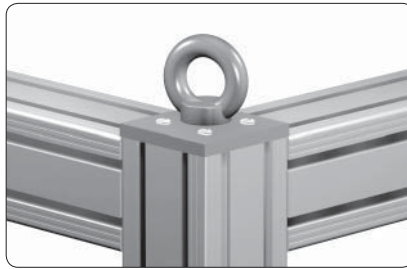

Mounting with base plates

Application

Eye-bolts for the transfer of frames and complete equipment

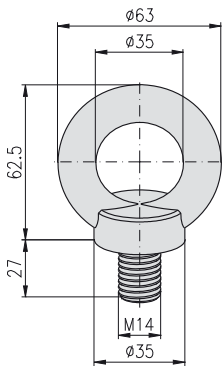

Technical data

material: C 15

max. load 1):

- for one eye-bolt 5,000 N
- for two eye-bolts total 7,000 N

1) The max. load given is valid only if the eye-bolt face is tightened firmly

Description

Eye-bolt M14

Weight

193 g

Article-No.

1.47.96314

Corner pieces

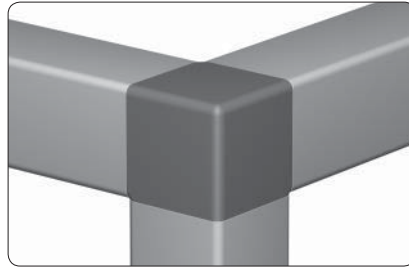

Corner piece set cubic PA: For the connection of three profiles 40×40

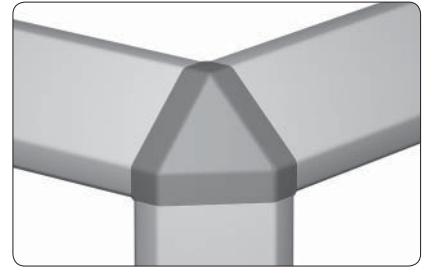

Corner piece set 45° PA: For the connection of three profiles 40×40, 2E, 45°, LP

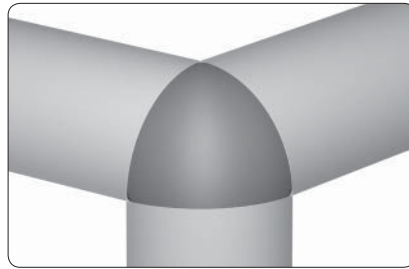

Corner piece set spherical PA: For the connection of three profiles 40×40, soft

Technical data

- Cover cap:
material: PA, black
- Angle:
material: GD-Zn

Delivery unit (set)

- Corner piece angle
- Corner piece cover cap
- Threaded insert M14/M8 (3 pcs)
- Cap head screw (3 pcs)

Cubic

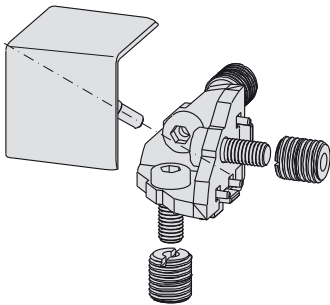

16 20 30 40 45 50 60

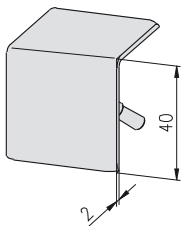

Description

Corner piece set cubic PA

Weight

136.0 g

Article-No.

1.48.14410

Description

Corner piece cover cap, cubic PA

Weight

15.5 g

Article-No.

1.48.14412

45°

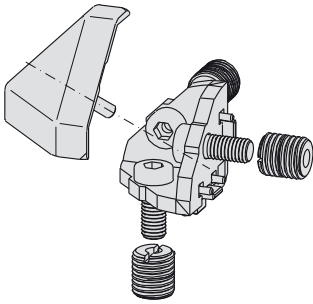

Description	Weight	Article-No.
Corner piece set 45° PA	128.0 g	1.48.14440

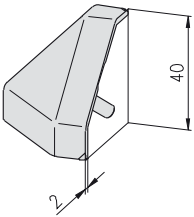

Description	Weight	Article-No.
Corner piece cover cap, 45° PA	7.5 g	1.48.14442

Spherical

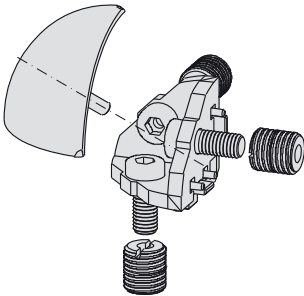

Description	Weight	Article-No.
Corner piece set spherical PA	129.0 g	1.48.14480

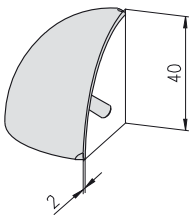

Description	Weight	Article-No.
Corner piece cover cap, spherical PA	8.5 g	1.48.14482

Corner pieces



Corner pieces cubic:
Corner piece for the connection of 3 square profiles



Corner pieces segment:
Corner piece for the connection of 2 square profiles and 1 soft profile

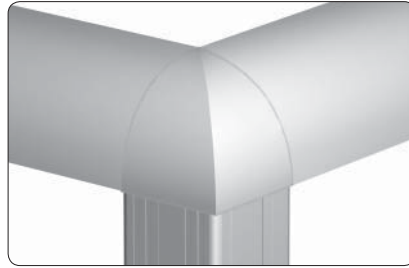

Corner pieces segment, 2gang:
Corner piece for the connection of 2 soft profiles and 1 square profile

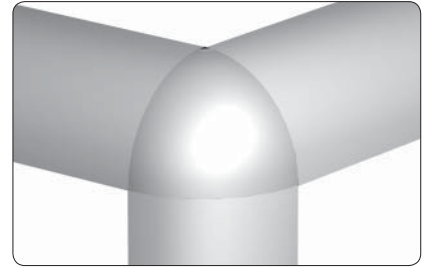

Corner pieces sphere:
Corner piece for the connection of 3 soft profiles

Technical data

material: aluminium
strength: F22
surface: natural anodised

General

The attractive corner pieces are made of solid aluminium and guarantee the entire connection stability

Connection with corner pieces

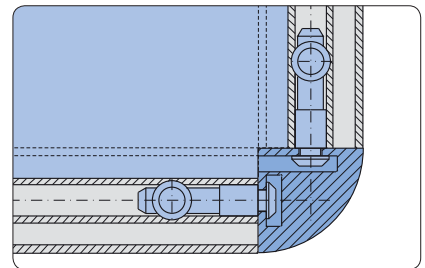

Connection of profiles with one corner piece using the standard connector

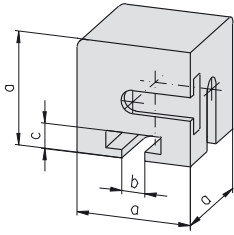
Corner pieces cubic

16 20 30 40 45 50 60

Description	a	Slot	b	c	Weight	Article-No.
Corner piece cubic	20	H	6.2	4.6	17 g	1.48.221
Corner piece cubic	30	F	8.2	6.2	59 g	1.48.331
Corner piece cubic	40	E3	8.2	9.0	135 g	1.48.441
Corner piece cubic	50	E4	8.2	10.0	292 g	1.48.551

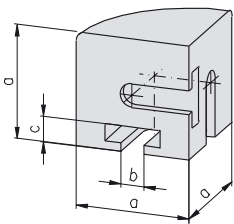
Corner pieces segment

16 20 30 40 45 50 60

Description	a	Slot	b	c	Weight	Article-No.
Corner piece segment	20	H	6.2	4.6	12 g	1.48.222
Corner piece segment	30	F	8.2	6.2	43 g	1.48.332
Corner piece segment	40	E3	8.2	9.0	100 g	1.48.442
Corner piece segment	50	E4	8.2	10.0	222 g	1.48.552

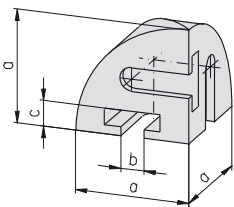
Corner pieces segment, 2gang

16 20 30 40 45 50 60

Description	a	Slot	b	c	Weight	Article-No.
Corner piece segment, 2gang	20	H	6.2	4.6	7 g	1.48.223
Corner piece segment, 2gang	30	F	8.2	6.2	24 g	1.48.333
Corner piece segment, 2gang	40	E3	8.2	9.0	57 g	1.48.443
Corner piece segment, 2gang	50	E4	8.2	10.0	135 g	1.48.553

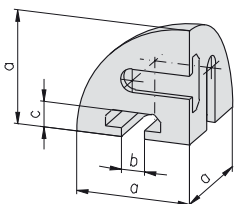





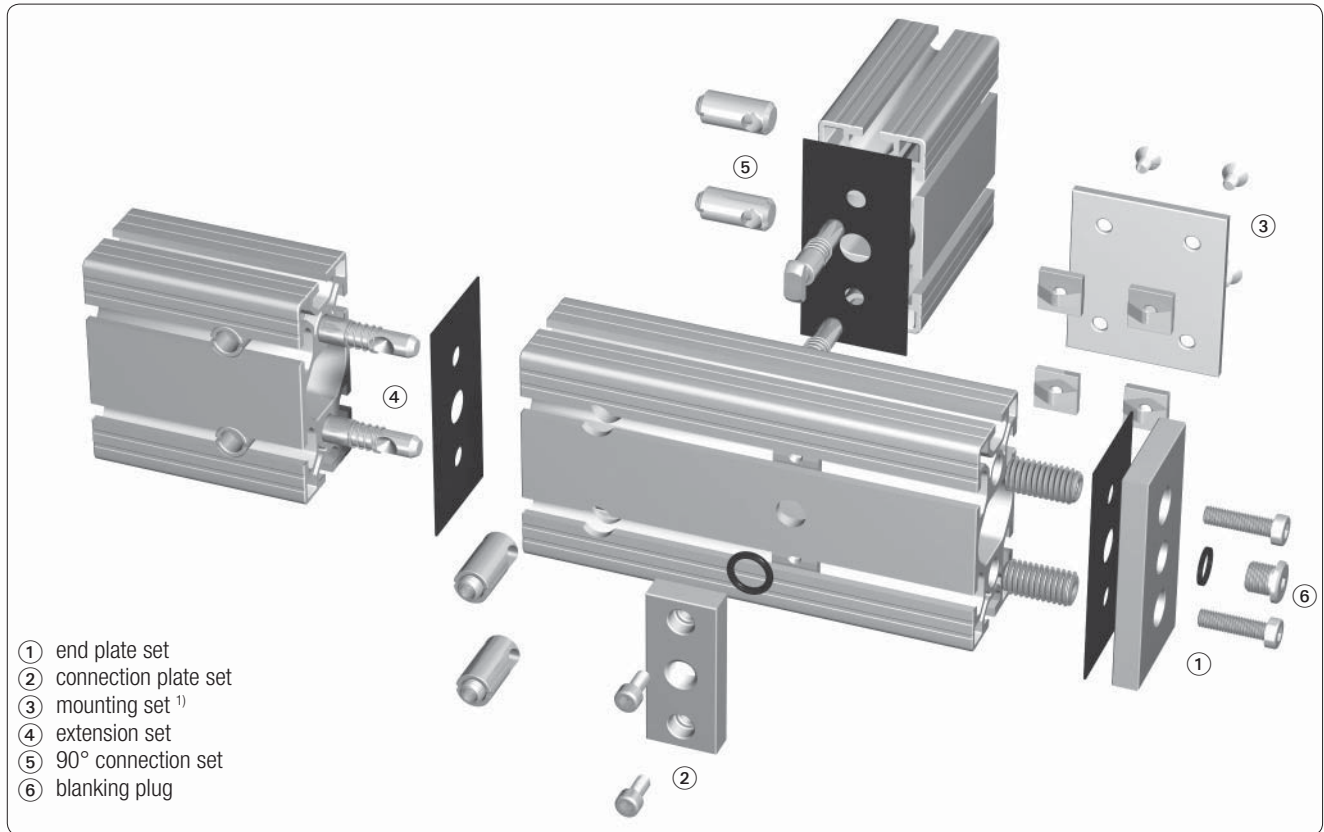



Corner pieces sphere

16 20 30 40 45 50 60

Description	a	Slot	b	c	Weight	Article-No.
Corner piece sphere	20	H	6.2	4.6	7 g	1.48.228
Corner piece sphere	30	F	8.2	6.2	24 g	1.48.338
Corner piece sphere	40	E3	8.2	9.0	57 g	1.48.448
Corner piece sphere	50	E4	8.2	10.0	135 g	1.48.558

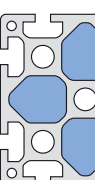

¹⁾ for mounting set → connection plate 1.47.50...

PG 30	PG 40	PG 45	PG 50	PG 60
 Profile 30×60, 6F ²⁾ 299.8 mm ²	 Profile 40×80, 6E ²⁾ 521.8 mm ²	 Profile 45×90, 6E ²⁾ 816.2 mm ²	 Profile 50×100, 6E ²⁾ 1,043.3 mm ²	 Profile 60×90, 6E ²⁾ 1,203.0 mm ²
	 Profile 80×80, 8E ²⁾ 2,454.1 mm ²	 Profile 90×90, 8E ²⁾ 635.2 mm ² (4×)	 Profile 100×100, 8E ²⁾ 4,080.4 mm ²	
	 Profile 80×80, 8E, angle ²⁾ 505.7 mm ² (2×)		 Profile 50×150, 8E ²⁾ 1,115.8 mm ² (2×)	<div style="border: 1px solid gray; padding: 5px;"> <p>Comments Any profile with closed interior chambers can also be used as pressure line max. pressure: 10 bar</p> </div>

²⁾ (pneumatic) cross-sectional area

Pneumatic end plates

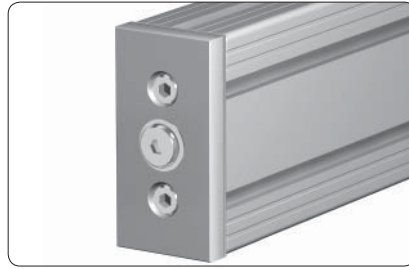
Application

- for the closing of profile ends
- vent disconnection thread

Comments

Blanking plug and reducing nipple
 ↗ *Pneumatic accessories 1.59*
 Article-No. 1.59.010□□ and
 1.59.020□□

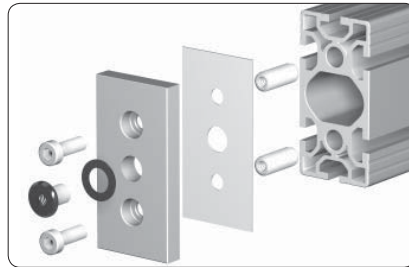
Technical data
End plate

- material: aluminium
- strength: F22
- surface: black powder-coated

Seal

- material: NBR

Comments

Counterbore DIN 74 - M6 / M8 for
 cap-screw DIN 912 - M6 / M8

Variants

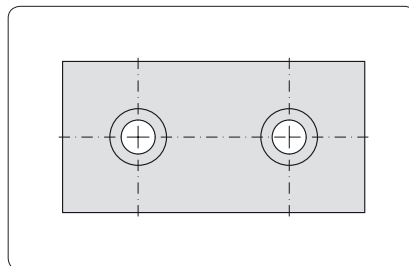

without thread

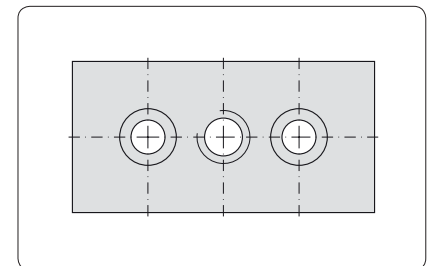

with thread

Dimensions	without thread	with thread G1/4"	with thread G1/2"
B×L	Article-No.	Article-No.	Article-No.
30×60	1.47.2030060.0600.1	1.51.13061	
40×80	1.47.2040080.0800.1		1.51.14081
45×90	1.47.2045090.0800.1		1.51.14591
50×100	1.47.2050100.0800.1		1.51.15101
50×150	1.47.2050150.0800.1		1.51.15151
60×90	1.47.2060090.0800.1		1.51.16091
80×80 angle	1.47.2080080W.0800.1		1.51.18081W
80×80	1.47.2080080.0800.1		1.51.18081
100×100	1.47.2100100.0800.1		1.51.20101

Pneumatic end plate sets
 without thread

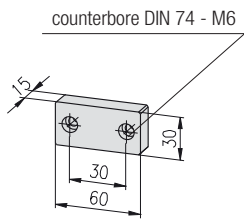
30×60

Description	Weight	Article-No.
Pneumatic end plate set w/o thread 30×60	121 g	1.50.2030060.0600.0

Single parts	Pcs.	Weight	Article-No.
Base plate w/o thread 30×60	1	64 g	1.47.2030060.0600.1
Pneumatic seal 30×60	1	3 g	1.51.13062
Threaded insert M14/M6	2	22 g	1.35.1140615
Cap-screw DIN 912 - M6×16	2	5 g	0.63.D00912.06016

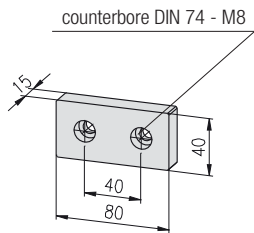
40×80

Description	Weight	Article-No.
Pneumatic end plate set w/o thread 40×80	173 g	1.50.2040080.0800.0

Single parts	Pcs.	Weight	Article-No.
Base plate w/o thread 40×80	1	114 g	1.47.2040080.0800.1
Pneumatic seal 40×80	1	5 g	1.51.14082
Threaded insert M14/M8	2	18 g	1.35.1140815
Cap-screw DIN 912 - M8×16	2	9 g	0.63.D00912.08016

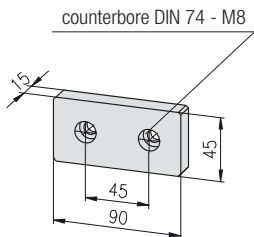
45×90

Description	Weight	Article-No.
Pneumatic end plate set w/o thread 45×90	208 g	1.50.2045090.0800.0

Single parts	Pcs.	Weight	Article-No.
Base plate w/o thread 45×90	1	148 g	1.47.2045090.0800.1
Pneumatic seal 45×90	1	6 g	1.51.14592
Threaded insert M14/M8	2	18 g	1.35.1140815
Cap-screw DIN 912 - M8×16	2	9 g	0.63.D00912.08016

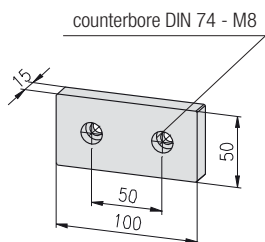
50×100

Description	Weight	Article-No.
Pneumatic end plate set w/o thread 50×100	247 g	1.50.2050100.0800.0

Single parts	Pcs.	Weight	Article-No.
Base plate w/o thread 50×100	1	186 g	1.47.2050100.0800.1
Pneumatic seal 50×100	1	7 g	1.51.15102
Threaded insert M14/M8	2	18 g	1.35.1140815
Cap-screw DIN 912 - M8×16	2	9 g	0.63.D00912.08016

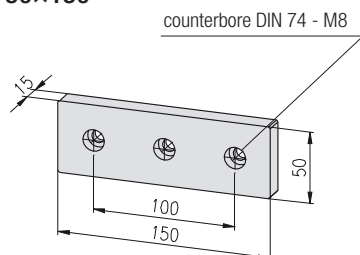
50×150

Description	Weight	Article-No.
Pneumatic end plate set w/o thread 50×150	371 g	1.50.2050150.0800.0

Single parts	Pcs.	Weight	Article-No.
Base plate w/o thread 50×150	1	280 g	1.47.2050150.0800.1
Pneumatic seal 50×150	1	10 g	1.51.15152
Threaded insert M14/M8	3	18 g	1.35.1140815
Cap-screw DIN 912 - M8×16	3	9 g	0.63.D00912.08016

Pneumatic end plate sets
 without thread

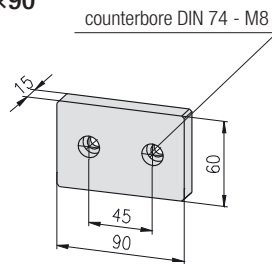
60×90

Description	Weight	Article-No.
Pneumatic end plate set w/o thread 60×90	263 g	1.50.2060090.0800.0
Single parts		
	Pcs.	
Base plate w/o thread 60×90	1 202 g	1.47.2060090.0800.1
Pneumatic seal 60×90	1 7 g	1.51.16092
Threaded insert M14/M8	2 18 g	1.35.1140815
Cap-screw DIN 912 - M8×16	2 9 g	0.63.D00912.08016

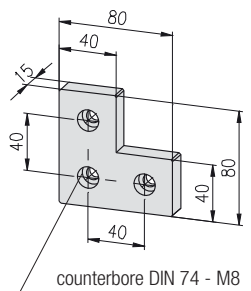
80×80 angle

Description	Weight	Article-No.
Pneumatic end plate set w/o thread 80×80 W	260 g	1.50.2080080W.0800.0
Single parts		
	Pcs.	
Base plate w/o thread 80×80 W	1 171 g	1.47.2080080W.0800.1
Pneumatic seal 80×80 W	1 8 g	1.51.18082W
Threaded insert M14/M8	3 18 g	1.35.1140815
Cap-screw DIN 912 - M8×16	3 9 g	0.63.D00912.08016

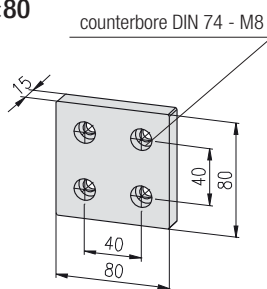
80×80

Description	Weight	Article-No.
Pneumatic end plate set w/o thread 80×80	343 g	1.50.2080080.0800.0
Single parts		
	Pcs.	
Base plate w/o thread 80×80	1 228 g	1.47.2080080.0800.1
Pneumatic seal 80×80	1 7 g	1.51.18082
Threaded insert M14/M8	4 18 g	1.35.1140815
Cap-screw DIN 912 - M8×16	4 9 g	0.63.D00912.08016

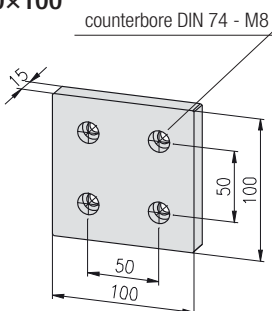
100×100

Description	Weight	Article-No.
Pneumatic end plate set w/o thread 100×100	494 g	1.50.2100100.0800.0
Single parts		
	Pcs.	
Base plate w/o thread 100×100	1 374 g	1.47.2100100.0800.1
Pneumatic seal 100×100	1 12 g	1.51.20102
Threaded insert M14/M8	4 18 g	1.35.1140815
Cap-screw DIN 912 - M8×16	4 9 g	0.63.D00912.08016

Pneumatic end plate sets
with thread

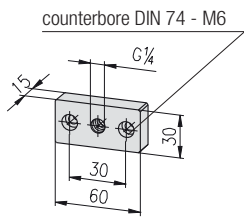
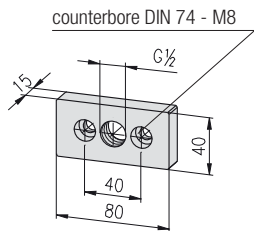
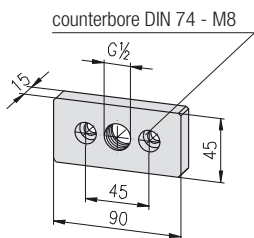
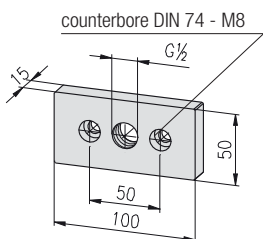
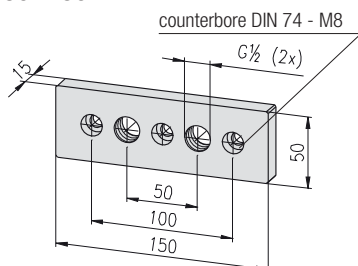
30×60

40×80

45×90

50×100

50×150

Description

Pneumatic end plate set 30×60

Weight

110 g

Article-No.

1.51.13060

Single parts

	Pcs.		
Pneumatic end plate 30×60	1	53 g	1.51.13061
Pneumatic seal 30×60	1	3 g	1.51.13062
Threaded insert M14/M6	2	22 g	1.35.1140615
Cap-screw DIN 912 - M6×16	2	5 g	0.63.D00912.06016

Description

Pneumatic end plate set 40×80

Weight

153 g

Article-No.

1.51.14080

Single parts

	Pcs.		
Pneumatic end plate 40×80	1	94 g	1.51.14081
Pneumatic seal 40×80	1	5 g	1.51.14082
Threaded insert M14/M8	2	18 g	1.35.1140815
Cap-screw DIN 912 - M8×16	2	9 g	0.63.D00912.08016

Description

Pneumatic end plate set 45×90

Weight

179 g

Article-No.

1.51.14590

Single parts

	Pcs.		
Pneumatic end plate 45×90	1	119 g	1.51.14591
Pneumatic seal 45×90	1	6 g	1.51.14592
Threaded insert M14/M8	2	18 g	1.35.1140815
Cap-screw DIN 912 - M8×16	2	9 g	0.63.D00912.08016

Description

Pneumatic end plate set 50×100

Weight

206 g

Article-No.

1.51.15100

Single parts

	Pcs.		
Pneumatic end plate 50×100	1	145 g	1.51.15101
Pneumatic seal 50×100	1	7 g	1.51.15102
Threaded insert M14/M8	2	18 g	1.35.1140815
Cap-screw DIN 912 - M8×16	2	9 g	0.63.D00912.08016

Description

Pneumatic end plate set 50×150

Weight

322 g

Article-No.

1.51.15150

Single parts

	Pcs.		
Pneumatic end plate 50×150	1	231 g	1.51.15151
Pneumatic seal 50×150	1	10 g	1.51.15152
Threaded insert M14/M8	3	18 g	1.35.1140815
Cap-screw DIN 912 - M8×16	3	9 g	0.63.D00912.08016

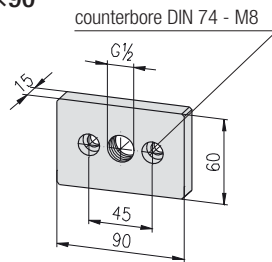
**Pneumatic end plate sets
with thread**
60×90

Description	Weight	Article-No.
Pneumatic end plate set 60×90	217 g	1.51.16090
Single parts		
Pneumatic end plate 60×90	1 156 g	1.51.16091
Pneumatic seal 60×90	1 7 g	1.51.16092
Threaded insert M14/M8	2 18 g	1.35.1140815
Cap-screw DIN 912 - M8×16	2 9 g	0.63.D00912.08016

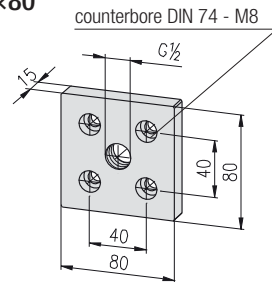
80×80

Description	Weight	Article-No.
Pneumatic end plate set 80×80	251 g	1.51.18080
Single parts		
Pneumatic end plate 80×80	1 136 g	1.51.18081
Pneumatic seal 80×80	1 7 g	1.51.18082
Threaded insert M14/M8	4 18 g	1.35.1140815
Cap-screw DIN 912 - M8×16	4 9 g	0.63.D00912.08016

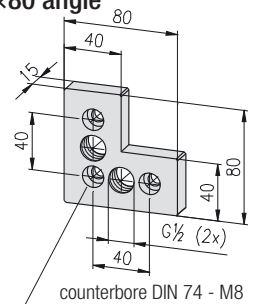
80×80 angle

Description	Weight	Article-No.
Pneumatic end plate set 80×80 W	271 g	1.51.18080W
Single parts		
Pneumatic end plate 80×80 W	1 182 g	1.51.18081W
Pneumatic seal 80×80 W	1 8 g	1.51.18082W
Threaded insert M14/M8	3 18 g	1.35.1140815
Cap-screw DIN 912 - M8×16	3 9 g	0.63.D00912.08016

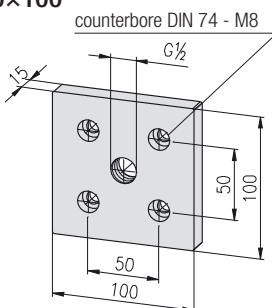
100×100

Description	Weight	Article-No.
Pneumatic end plate set 100×100	416 g	1.51.20100
Single parts		
Pneumatic end plate 100×100	1 296 g	1.51.20101
Pneumatic seal 100×100	1 12 g	1.51.20102
Threaded insert M14/M8	4 18 g	1.35.1140815
Cap-screw DIN 912 - M8×16	4 9 g	0.63.D00912.08016

Pneumatic connection plates

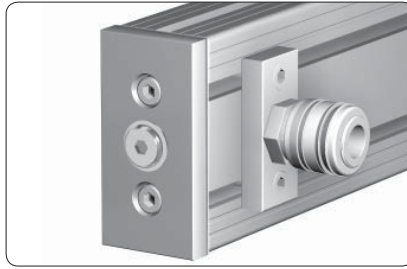
Application

Pneumatic connection for inlet and exhaust of air pressure

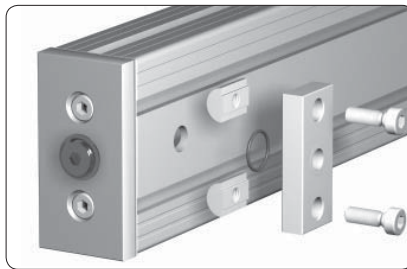
Technical data

End plate

- material: aluminium
 - strength: F22
 - surface: black powder-coated
- O-Ring
- material: NBR

Comments

Counterbore DIN 74 - M6 / M8 for cap-screw DIN 912 - M6 / M8

30×60

counterbore DIN 74 - M6

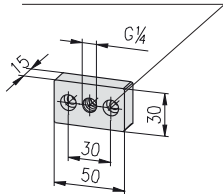
Description

Pneumatic connection plate set 30×60

Weight

59.2 g

Article-No.

1.52.03061

Single parts
Pcs.

Pneumatic connection plate 30×60	1	40.0 g	1.52.03062
O-Ring 14×3	1	0.6 g	1.59.11403
T-Nut for subs. insertion F, M6	2	4.3 g	1.32.4FM6
Cap-screw DIN 912 - M6×12	2	5.0 g	0.63.D00912.06012

40×80

counterbore DIN 74 - M6

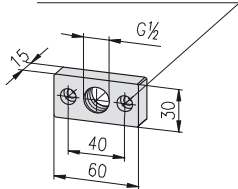
Description

Pneumatic connection plate set 40×80

Weight

80.6 g

Article-No.

1.52.14081

Single parts
Pcs.

Pneumatic connection plate 40×80	1	50.0 g	1.52.14082
O-Ring 20×3	1	0.6 g	1.59.12003
T-Nut for subs. insertion E, M6	2	10.0 g	1.32.4EM6
Cap-screw DIN 912 - M6×16	2	5.0 g	0.63.D00912.06016

45×90

counterbore DIN 74 - M6

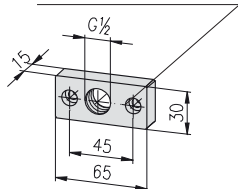
Description

Pneumatic connection plate set 45×90

Weight

84.6 g

Article-No.

1.52.04591

Single parts
Pcs.

Pneumatic connection plate 45×90	1	5.0 g	1.52.04592
O-Ring 20×3	1	0.6 g	1.59.12003
T-Nut for subs. insertion E, M6	2	10.0 g	1.32.4EM6
Cap-screw DIN 912 - M6×16	2	5.0 g	0.63.D00912.06016

50×100

counterbore DIN 74 - M6

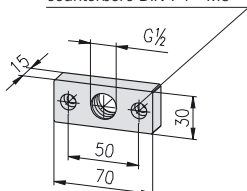
Description

Pneumatic connection plate set 50×100

Weight

90.6 g

Article-No.

1.52.15101

Single parts
Pcs.

Pneumatic connection plate 50×100	1	60.0 g	1.52.15102
O-Ring 20×3	1	0.6 g	1.59.12003
T-Nut for subs. insertion E, M6	2	10.0 g	1.32.4EM6
Cap-screw DIN 912 - M6×16	2	5.0 g	0.63.D00912.06016

Pneumatic extension sets

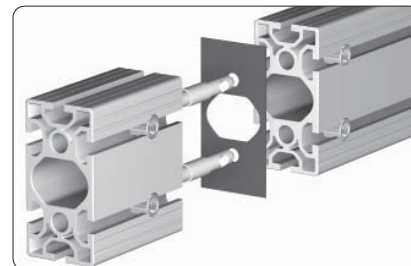
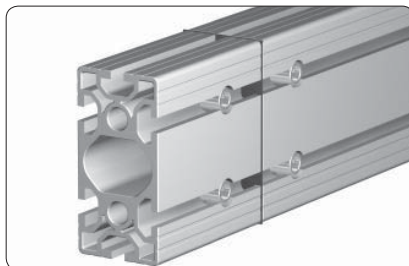

For the extension of air pressurised profiles

for profile 30×60

Description	Pcs.	Weight	Article-No.
Pneumatic extension set 30×60		177 g	1.54.03061
Single parts			
Pneumatic seal 30×60	1	3 g	1.51.13062
Connector, profile extension	2	87 g	1.21.3V0

for profile 40×80

Pneumatic extension set 40×80		193 g	1.54.04081
Single parts			
Pneumatic seal 40×80	1	5 g	1.51.14082
Connector, profile extension	2	94 g	1.21.4V0

for profile 45×90

Pneumatic extension set 45×90		204 g	1.54.04591
Single parts			
Pneumatic seal 45×90	1	6 g	1.51.14592
Connector, profile extension	2	99 g	1.21.45V0

for profile 50×100

Pneumatic extension set 50×100		211 g	1.54.05101
Single parts			
Pneumatic seal 50×100	1	7 g	1.51.15102
Connector, profile extension	2	102 g	1.21.5V0

for profile 50×150

Pneumatic extension set 50×150		316 g	1.54.05151
Single parts			
Pneumatic seal 50×150	1	10 g	1.51.15152
Connector, profile extension	3	102 g	1.21.5V0

for profile 60×90

Pneumatic extension set 60×90		239 g	1.54.06091
Single parts			
Pneumatic seal 60×90	1	7 g	1.51.16092
Connector, profile extension	2	116 g	1.21.6V0

for profile 80×80 angle

Pneumatic extension set 80×80 W		289 g	1.54.08081W
Single parts			
Pneumatic seal 80×80 W	1	7 g	1.51.18082W
Connector, profile extension	3	94g	1.21.4V0

for profile 80×80

Pneumatic extension set 80×80		384 g	1.54.08081
Single parts			
Pneumatic seal 80×80	1	8 g	1.51.18082
Connector, profile extension	4	94 g	1.21.4V0

for profile 100×100

Pneumatic extension set 100×100		420 g	1.54.10101
Single parts			
Pneumatic seal 100×100	1	12 g	1.51.20102
Connector, profile extension	4	102 g	1.21.5V0

Pneumatic 90° connection sets



For 90° connections of air pressurised profiles

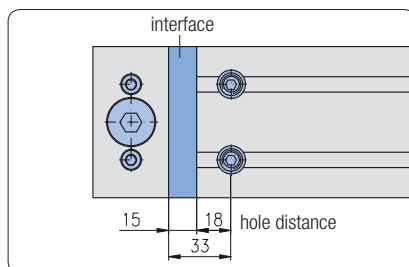
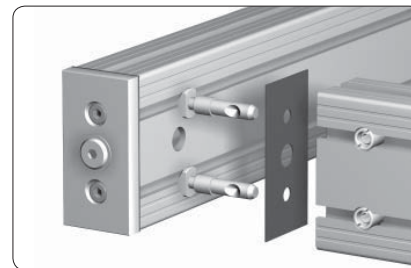

For the connection of profile 80×80, 100×100 a pneumatic connecting plate must be inserted to seal the chamber inside

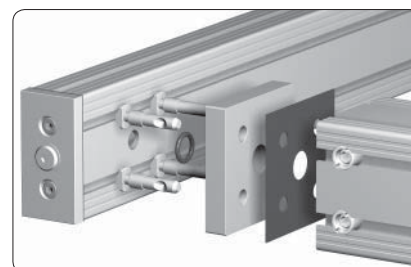
for profile 30×60

Description	Pcs.	Weight	Article-No.
Pneumatic 90° connection set 30×60		99 g	1.55.03061
Single parts			
Pneumatic seal 30×60	1	3 g	1.51.13062
Connector, standard 90°	2	48 g	1.21.3F2

for profile 40×80

Pneumatic 90° connection set 40×80		115 g	1.55.04081
Single parts			
Pneumatic seal 40×80	1	5 g	1.51.14082
Connector, standard 90°	2	55 g	1.21.4E2

for profile 45×90

Pneumatic 90° connection set 45×90		63 g	1.55.04591
Single parts			
Pneumatic seal 45×90	1	6 g	1.51.14592
Connector, standard 90°	2	57 g	1.21.45E2

for profile 50×100

Pneumatic 90° connection set 50×100		125 g	1.55.05101
Single parts			
Pneumatic seal 50×100	1	7 g	1.51.15102
Connector, standard 90°	2	59 g	1.21.5E2

for profile 50×150

Pneumatic 90° connection set 50×150		187 g	1.55.05151
Single parts			
Pneumatic seal 50×150	1	10 g	1.51.15152
Connector, standard 90°	3	59 g	1.21.5E2

for profile 60×90

Pneumatic 90° connection set 60×90		70 g	1.55.06091
Single parts			
Pneumatic seal 60×90	1	7 g	1.51.16092
Connector, standard 90°	2	63 g	1.21.6E2

for profile 80×80

Pneumatic 90° connection set 80×80		446 g	1.55.08081
Single parts			
Pneumatic seal 80×80	1	8 g	1.51.18082
Connector, standard 90°	4	55 g	1.21.4E2
Pneumatic connecting plate	1	217 g	1.55.08084
O-Ring 20×3	1	0.6 g	1.59.12003

for profile 100×100

Description	Pcs.	Weight	Article-No.
Pneumatic 90° connection set 100×100		618 g	1.55.10101
Single parts			
Pneumatic seal 100×100	1	12 g	1.51.20102
Connector, standard 90°	4	55 g	1.21.5E2
Pneumatic connecting plate	1	369 g	1.55.10104
O-Ring 20×3	1	0.6 g	1.59.12003

Pneumatic accessories



Application

Blanking plug for the connection thread

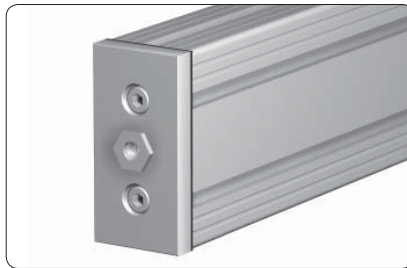

Application

Reducing nipple to reduce the connection thread

Blanking plug

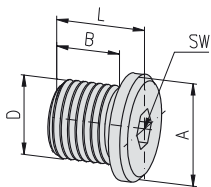

Technical data

- material:
- blanking plug: steel, galvanised
 - sealing: NBR

Comments

Including sealing

Description	D	A	B	L	SW	Weight	Article-No.
Blanking plug,	B-1/4"	18	12	15	6	15 g	1.59.01030
Blanking plug,	B-1/2"	26	14	18	10	43 g	1.59.01050

Reducing nipple

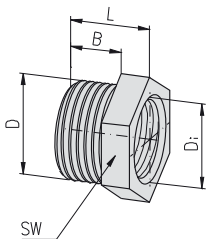

Technical data

material: brass

Description	Di	D	B	L	SW	Weight	Article-No.
Reducing nipple,	1/4" i - 3/8" a		9	14	19	14 g	1.59.02040
Reducing nipple,	3/8" i - 1/2" a		10	14	22	25 g	1.59.02050

Sealing ring
for reducing nipple

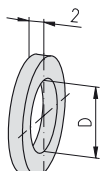

Technical data

material: PA, white

Description	D	Weight	Article-No.
Sealing ring	Ø1/4"	1 g	1.59.03030
Sealing ring	Ø3/8"	1 g	1.59.03040
Sealing ring	Ø1/2"	2 g	1.59.03050

Handles light PA



Application

For doors and drawers of light material

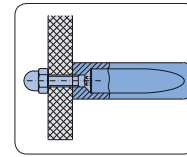

Mounting on panel elements

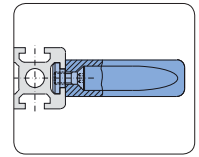

Mounting on profiles

Technical data

material: PA

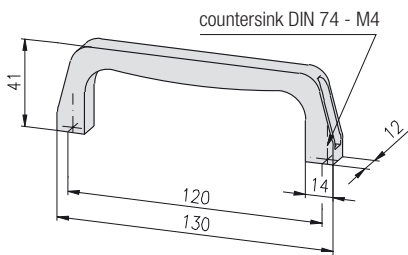

Description	Colour	Weight	Article-No.
Handle light PA	grey	30 g	1.61.20.1
Handle light PA	black	30 g	1.61.20.2

Handle light Alu



Application

For doors and drawers of light material

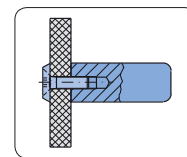

Mounting on panel elements

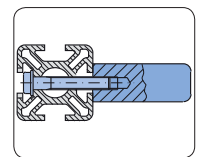

Mounting on profiles

Technical data

material: aluminium
surface: natural anodised

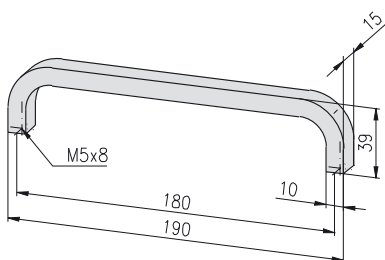

Description	Weight	Article-No.
Handle light Alu	85 g	1.61.210

Handle PA



Application

Ergonomical designed handle

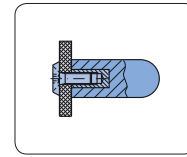

Mounting on panel elements

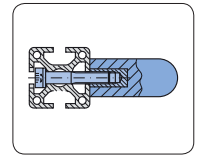

Mounting on profiles

Technical data

material: PA
colour: black

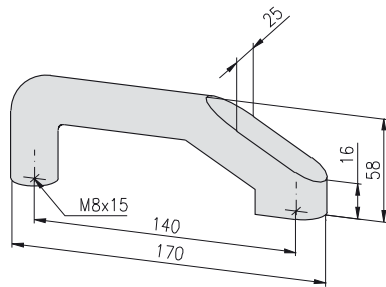

Description

Handle PA, with thread M8

Weight

166 g

Article-No.

1.61.230

Handles PA



Application

Handle with fixing possibilities from the front and the rear

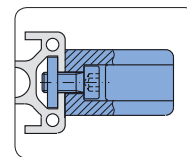

Handle with bore

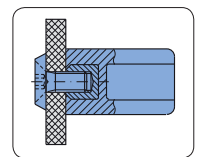

Handle with thread

Technical data

material: PA
colour: black

with bore

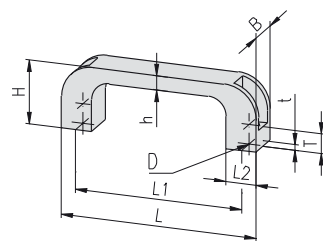

Description

Description	D	L	Weight	Article-No.
Handle PA, with bore	Ø6.5	110	24 g	1.61.24110
Handle PA, with bore	Ø6.5	139	44 g	1.61.24139
Handle PA, with bore	Ø8.5	151	64 g	1.61.24151
Handle PA, with bore	Ø8.5	200	74 g	1.61.24200
Handle PA, with bore	Ø10.5	260	114 g	1.61.24260

with thread

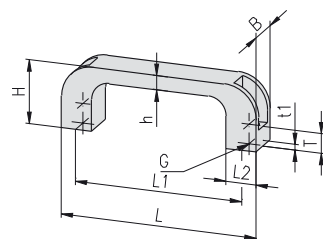

Description

Description	G	L	Weight	Article-No.
Handle PA, with thread	M6	110	30 g	1.61.25110
Handle PA, with thread	M6	139	50 g	1.61.25139
Handle PA, with thread	M8	151	70 g	1.61.25151
Handle PA, with thread	M8	200	88 g	1.61.25200
Handle PA, with thread	M10	260	125 g	1.61.25260

L	L1	L2	H	h	T	t	t1	B
110	94	17	37	8	13	6	10	21
139	120	20	40	10	15	6	10	24
151	132	22	43	10	16	6	15	26
200	180	25	50	11	20	9	15	28
260	235	28	53	12	21	11	15	32

Handles PA



Application

Machine handle with ergonomic design and finger protection; to mount on doors, flaps and aluminum profiles

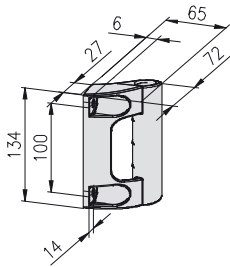

Technical data

material: PA
colour: black

Description

Handle PA, 135, with screw covers

Weight

117 g

Article-No.

1.61.26135

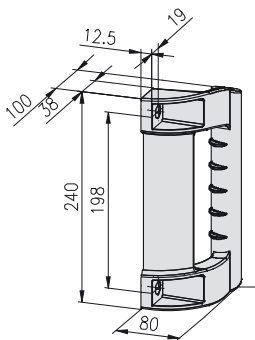

Technical data

material: PA
colour: black

Description

Handle PA, 240, with screw covers

Weight

356 g

Article-No.

1.61.26240

Handle system round design

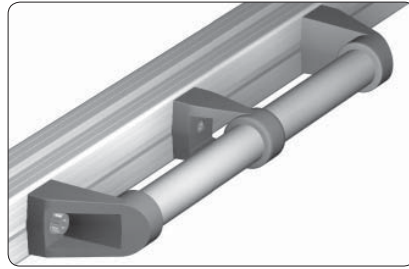

Application

Handle system for making handles of any length

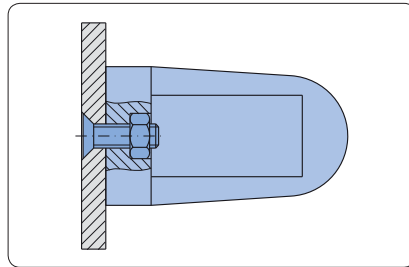

Mounting on panel elements

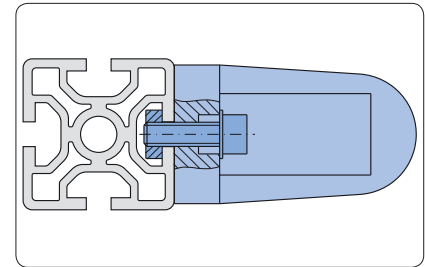

Mounting on profiles

Corner piece PA-GF

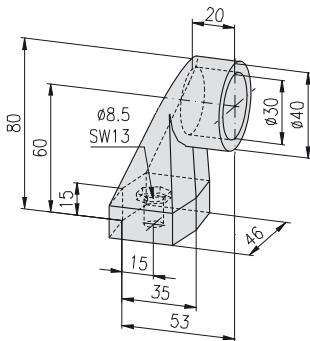

Technical data

material: PA-GF
colour: black

Description

Corner piece PA-GF

Weight

76 g

Article-No.

1.61.280

Centre piece PA-GF

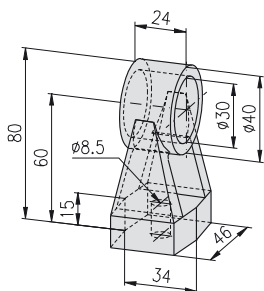

Technical data

material: PA-GF
colour: black

Description

Centre piece PA-GF

Weight

53 g

Article-No.

1.61.281

Tube Ø30×3

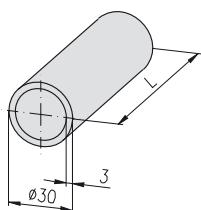

Technical data

material: aluminium
surface: natural anodised
tube length: 6 m

Description

Tube Ø30×3

bar

Weight

4.2 kg

Article-No.

1.19.16130.60



Tube Ø30×3

cut to length

0.7 kg/m

1.19.16130-A00A00/...

/... = length in mm

**Handle system
oval design**

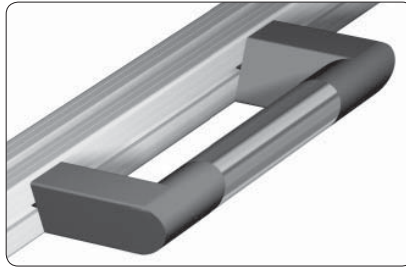

Application

Handle system for making handles of any length

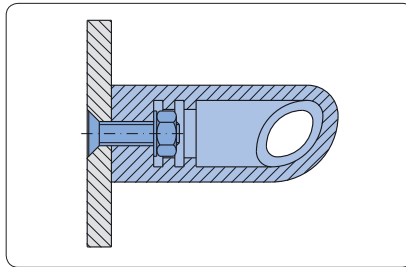

Mounting on panel elements

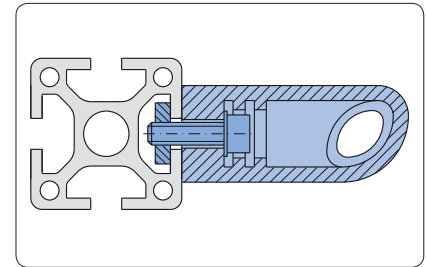

Mounting on profiles

Oval corner piece right

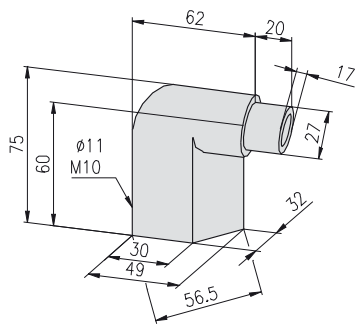

Technical data

material: PA-GF
colour: black

Description

Oval corner piece right

Weight

65 g

Article-No.

1.61.290

Oval corner piece left

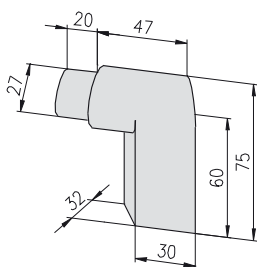

Technical data

material: PA-GF
colour: black

Description

Oval corner piece left

Weight

65 g

Article-No.

1.61.291

Oval tube 35x4

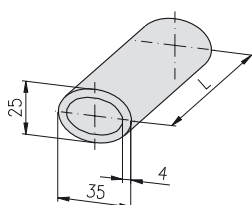

Technical data

material: aluminium
surface: natural anodised
tube length: 3 m

Description

Oval tube 35x4

bar

Weight

2.5 kg

Article-No.

1.61.292.30



Oval tube 35x4

cut to length

0.83 kg/m

1.61.292-A00A00/...

/... = length in mm

Grab handles



Application

Alu grip handles for customer's assembly from standard profiles

Comments

Grab handles increase the rigidity of panels without profile frames

Profile 20×30, 1F, LP

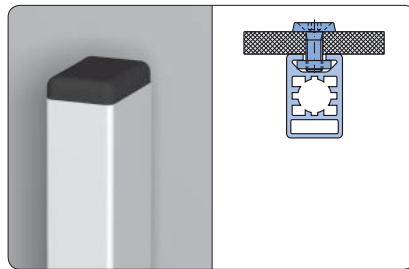
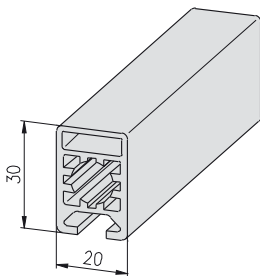

Fixing of the profile directly on the panel element

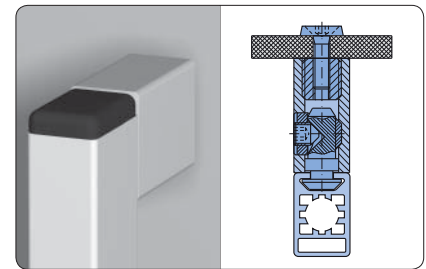

Fixing of the profile with a connecting piece on the panel element

Description

Description	Weight	Article-No.
Profile 20×30, 1F, LP cut to length	0.66 kg/m	1.11.020030.14LP-A00A00/... /... = length in mm

Grab handle profiles

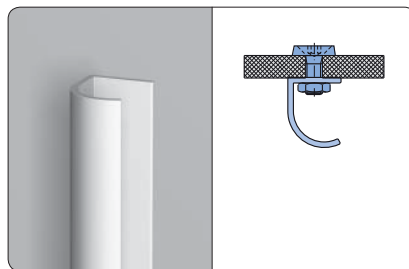
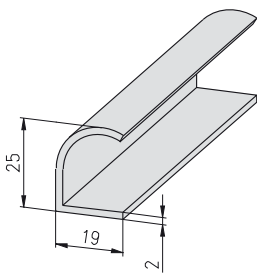

Description

Description	Weight	Article-No.
Grab handle profile cut to length	0.3 kg/m	1.19.14319-A00A00/... /... = length in mm

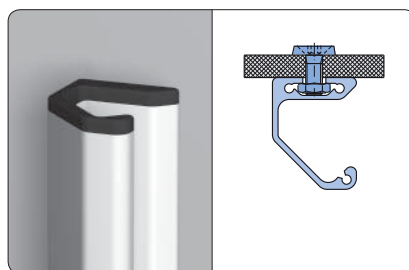
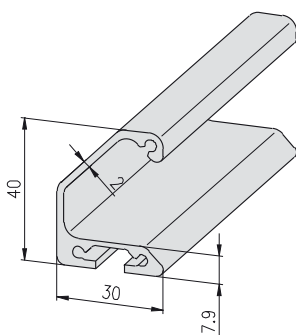

Description

Description	Weight	Article-No.
Grab handle profile cut to length	0.73 kg/m	1.19.14330-A00A00/... /... = length in mm

Technical data

material: PA-GF
colour: black

Description

Description	Weight	Article-No.
Cover cap kit left/right for grab handle profile	3.6 g	1.19.14330A

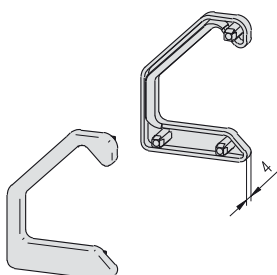

Hinges

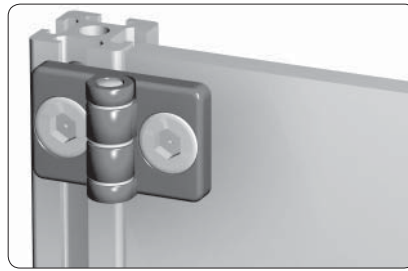

Application

Hinge for doors and flaps of light material

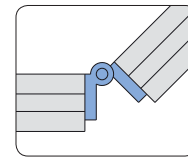

Face-sided connection of 2 profiles

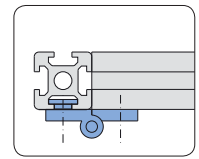

Connection of 2 profiles in rectangular position

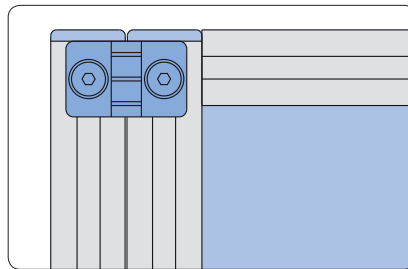

Doors with profile frames

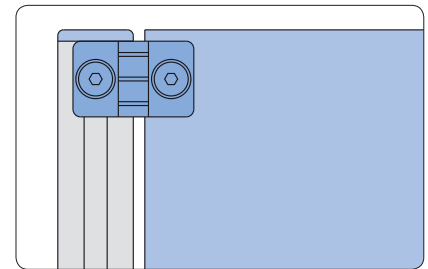

Doors made of panel elements without profile frames

Technical data			
Hinge	20×32	30×39	40×40
material:	PA-GF	PA-GF	GD-Zn, coated
colour:	black		
max. static load:	50 N	100 N	150 N

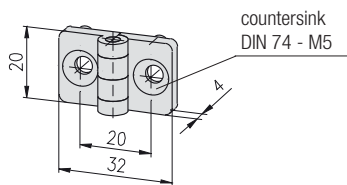

- 16
- 20
- 30
- 40
- 45
- 50
- 60

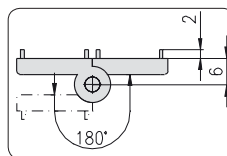

Swivel angle

Comments

Countersink DIN 74 - M5 for countersunk screw DIN 7991 - M5

Description

Hinge 20×32

Weight

6 g

Article-No.

1.62.12032

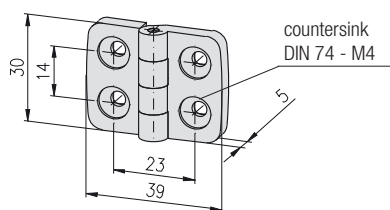

- 16
- 20
- 30
- 40
- 45
- 50
- 60

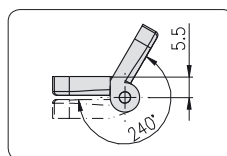

Swivel angle

Comments

Countersink DIN 74 - M4 for countersunk screw DIN 7991 - M4

Description

Hinge 30×39

Weight

7.6 g

Article-No.

1.62.23039

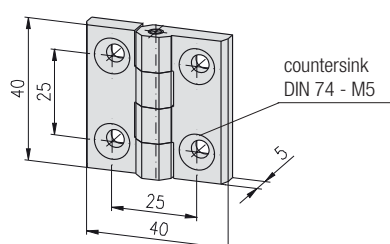

- 16
- 20
- 30
- 40
- 45
- 50
- 60

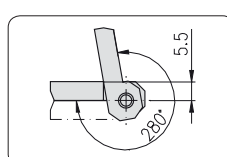

Swivel angle

Comments

Countersink DIN 74 - M5 for countersunk screw DIN 7991 - M5

Description

Hinge 40×40

Weight

55 g

Article-No.

1.62.24040

Lift-off hinges

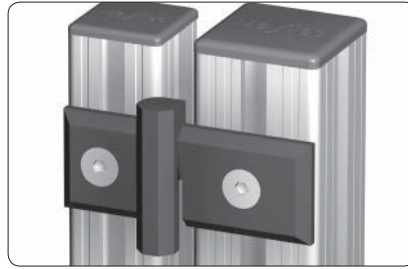

Application

Enables the connection of different profile widths in parallel as well as in rectangular arrangement

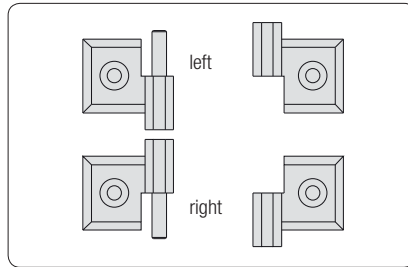

Non-liftable door with one right- and one left-sided hinge

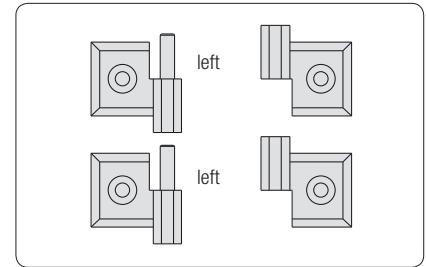

Liftable door with two similar hinges

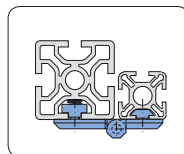

1 profile 30x30
1 profile 50x50

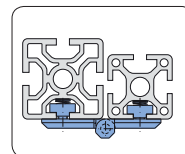

1 profile 40x40
1 profile 50x50

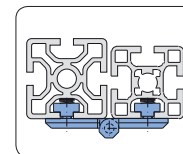

1 profile 45x45
1 profile 50x50

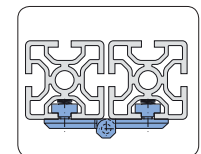

2 profiles 50x50

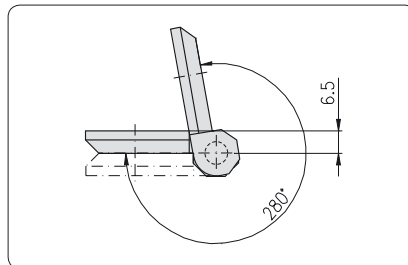

Swivel angle

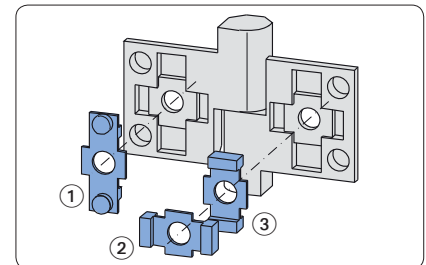

Application of locking device:

- ① for panel element
- ② for profile slot, horizontal
- ③ for profile slot, vertical

Technical data

material: GD-Zn
 surface: black coated
 hinge bolt: stainless steel
 max. static load: 250 N

Comments

Countersink DIN 74 - M6 for
 countersunk screw DIN 7991 - M6

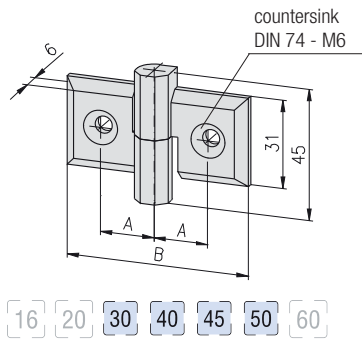

Description	A	B	Weight	Article-No.
Hinge 31, A16.5 left		59	68 g	1.62.331.16/16L
Hinge 31, A19.0 left		64	72 g	1.62.331.19/19L
Hinge 31, A21.5 left		69	76 g	1.62.331.21/21L
Hinge 31, A24.0 left		74	81 g	1.62.331.24/24L
Hinge 31, A26.5 left		79	86 g	1.62.331.26/26L

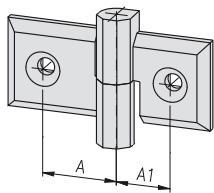

Combinations

Description	A ¹⁾	A1 ¹⁾	Article-No.
Hinge 31 × □□/□□ left			1.62.331.□□/□□L

¹⁾ Data without decimal places

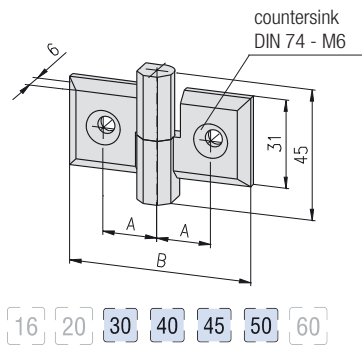

Description	A	B	Weight	Article-No.
Hinge 31, A16.5 right		59	68 g	1.62.331.16/16R
Hinge 31, A19.0 right		64	72 g	1.62.331.19/19R
Hinge 31, A21.5 right		69	76 g	1.62.331.21/21R
Hinge 31, A24.0 right		74	81 g	1.62.331.24/24R
Hinge 31, A26.5 right		79	86 g	1.62.331.26/26R

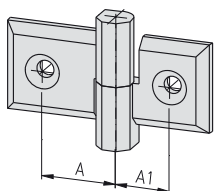

Combinations

Description	A ¹⁾	A1 ¹⁾	Article-No.
Hinge 31 × □□/□□ right			1.62.331.□□/□□R

¹⁾ Data without decimal places

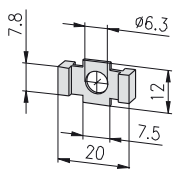

Technical data

material: GD-Zn
surface: bare

Description	Weight	Article-No.
Anti-twist device for slot 8 mm	4 g	1.62.331x1

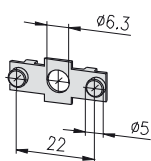

Technical data

material: GD-Zn
surface: bare

Description	Weight	Article-No.
Anti-twist device for panel element	4 g	1.62.331x2

Lift-off hinges

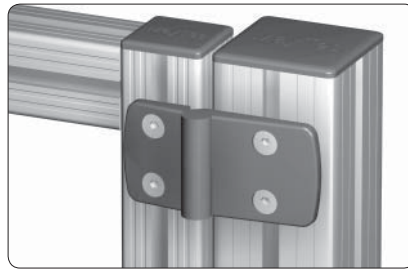

Application

The hinges enable the connection of profiles with different widths

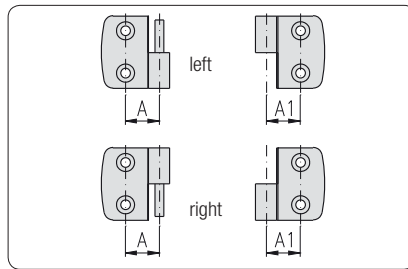

Non-liftable door with one right- and one left-sided hinge

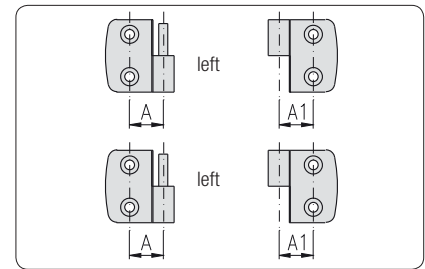

Liftable door with two similar hinges

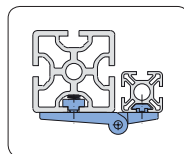

1 profile 60×60
1 profile 30×30

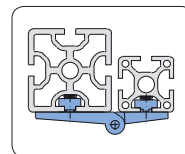

1 profile 60×60
1 profile 40×40

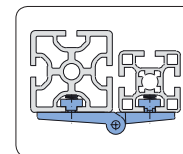

1 profile 60×60
1 profile 45×45

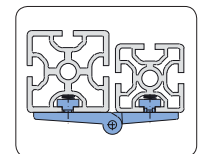

1 profile 60×60
1 profile 50×50

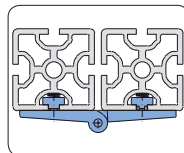

2 profiles 60×60

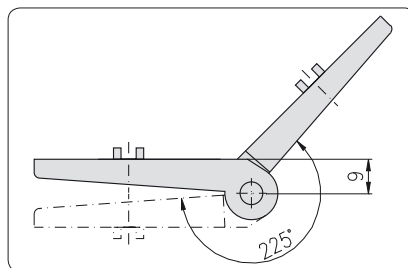

Swivel angle

Technical data

material: PA-GF
 surface: black
 hinge bolt: stainless steel
 max. static load: 150 N

Comments

Countersink DIN 74 - M6 for
 countersunk screw DIN 7991 - M6

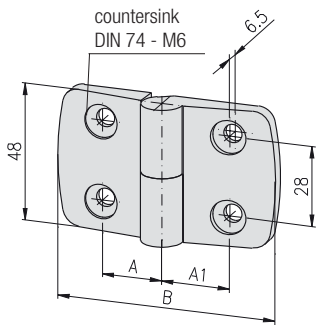

16 20 30 40 45 50 60

Description	A = A1	B	Weight	Article-No.
Lift-off hinge 48	A17.5, left	59	8 g	1.62.348.17/17L
Lift-off hinge 48	A22.5, left	77	10 g	1.62.348.22/22L
Lift-off hinge 48	A25.0, left	87	15 g	1.62.348.25/25L
Lift-off hinge 48	A27.5, left	97	25 g	1.62.348.27/27L
Lift-off hinge 48	A32.5, left	115	35 g	1.62.348.32/32L

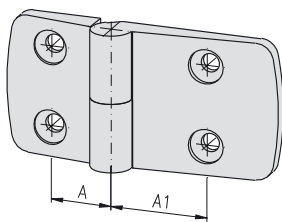

Combinations

Description	A ¹⁾ A1 ¹⁾	Article-No.
Lift-off hinge 48 × □□/□□ left		1.62.348.□□/□□L

¹⁾ Data without decimal places

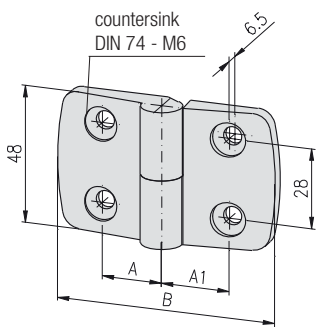

16 20 30 40 45 50 60

Description	A = A1	B	Weight	Article-No.
Lift-off hinge 48	A17.5, right	59	8 g	1.62.348.17/17R
Lift-off hinge 48	A22.5, right	77	10 g	1.62.348.22/22R
Lift-off hinge 48	A25.0, right	87	15 g	1.62.348.25/25R
Lift-off hinge 48	A27.5, right	97	25 g	1.62.348.27/27R
Lift-off hinge 48	A32.5, right	115	35 g	1.62.348.32/32R

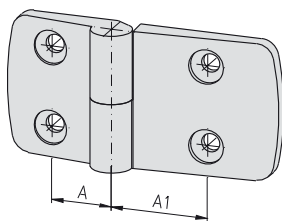

Combinations

Description	A ¹⁾ A1 ¹⁾	Article-No.
Lift-off hinge 48 × □□/□□ right		1.62.348.□□/□□R

¹⁾ Data without decimal places

Hinges

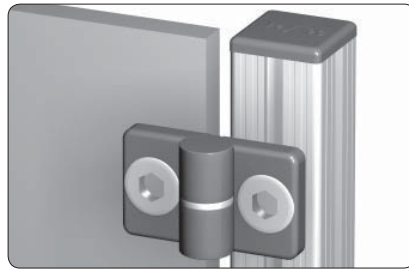

Application

Hinge for doors and flaps of light material

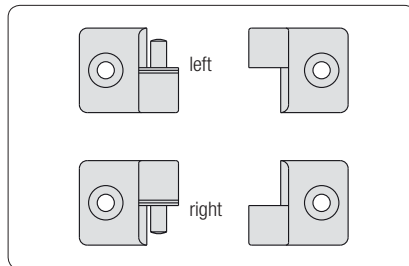

Non-liftable door with one right- and one left-sided hinge

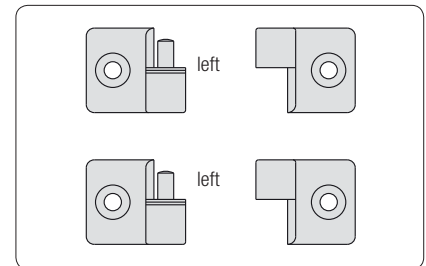

Liftable door with two similar hinges

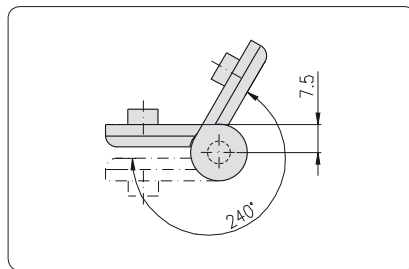

Swivel angle

Technical data

material: PA-GF
 colour: black
 max. static load: 100 N

Comments

Countersink DIN 74 - M6 for countersunk screw DIN 7991 - M6

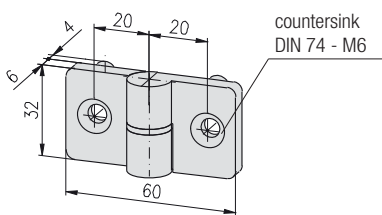

- 16
- 20
- 30
- 40
- 45
- 50
- 60

Description

Hinge 32x60 left

Weight

21 g

Article-No.

1.62.41L

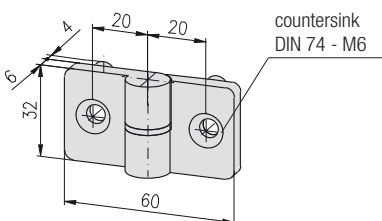

- 16
- 20
- 30
- 40
- 45
- 50
- 60

Description

Hinge 32x60 right

Weight

21 g

Article-No.

1.62.41R

Double hinge

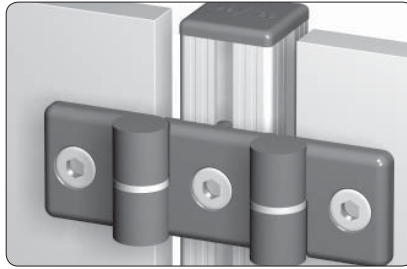

Application

Hinge for doors and flaps of light material

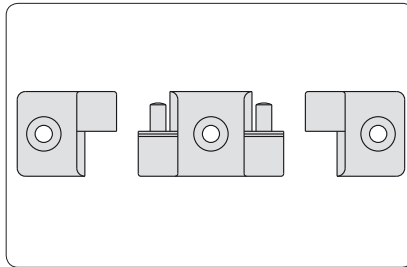

Liftable doors

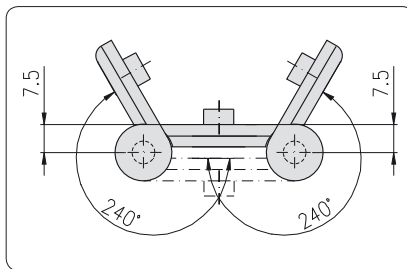

Swivel angle

Technical data

material: PA-GF
max. static load: 100 N

Comments

Countersink DIN 74 - M6 for countersunk screw DIN 7991 - M6

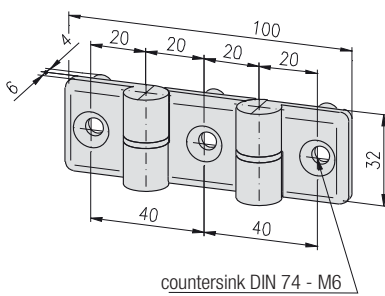

- 16
- 20
- 30
- 40
- 45
- 50
- 60

Description	Colour	Weight	Article-No.
Double hinge	grey	40 g	1.62.420.1
Double hinge	black	40 g	1.62.420.2

Hinges

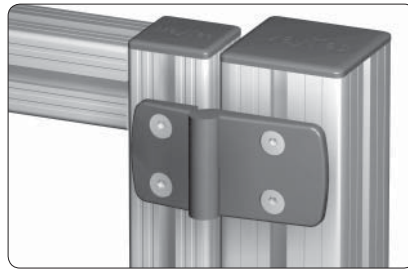

Application

The hinges enable the connection of profiles with different widths

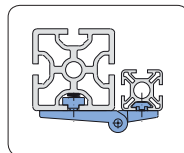

1 profile 60×60
1 profile 30×30

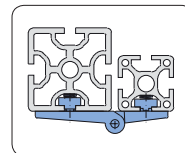

1 profile 60×60
1 profile 40×40

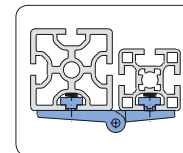

1 profile 60×60
1 profile 45×45

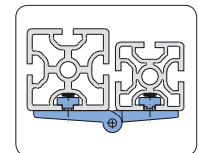

1 profile 60×60
1 profile 50×50

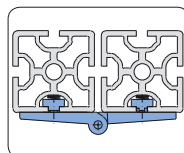

2 profiles 60×60

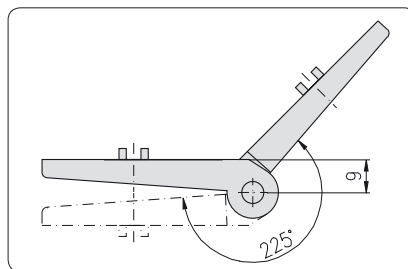

Swivel angle

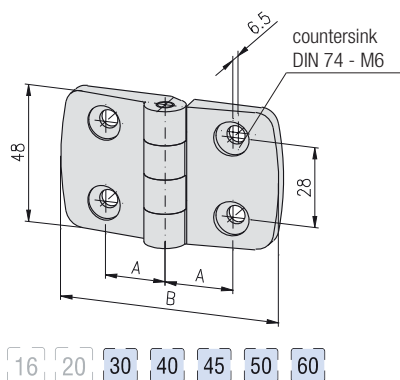

Technical data

material: PA-GF
colour: black
hinge bolt: stainless steel
max. static load: 200 N

Comments

Countersink DIN 74 - M6 for
countersunk screw DIN 7991 - M6

Description	A	B	Weight	Article-No.
Hinge 48 fixed	A17.5	59	8 g	1.62.448.17/17
Hinge 48 fixed	A22.5	77	10 g	1.62.448.22/22
Hinge 48 fixed	A25.0	87	15 g	1.62.448.25/25
Hinge 48 fixed	A27.5	97	25 g	1.62.448.27/27
Hinge 48 fixed	A32.5	115	35 g	1.62.448.32/32

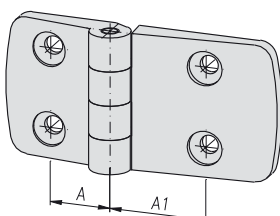

Combinations

Description	A ¹⁾	A1 ¹⁾	Article-No.
Hinge 48 fixed × □□/□□			1.62.448.□□/□□

¹⁾ Data without decimal places

Hinge
30×60

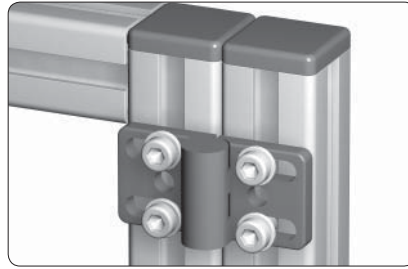

Application

Hinge or higher loads such as doors with profile frames

Technical data

material: GD-Zn
 colour: black
 surface: coated
 max. static load: 400 N

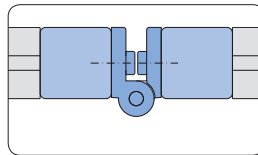

Connection of 2 vertical profiles, all anti-twist safety devices removed

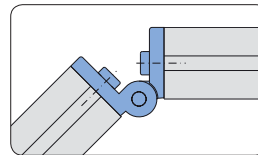

Face-sided connection of 2 profiles, with anti-twist safety device

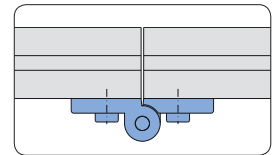

Connection of 2 horizontal profiles, with anti-twist safety device

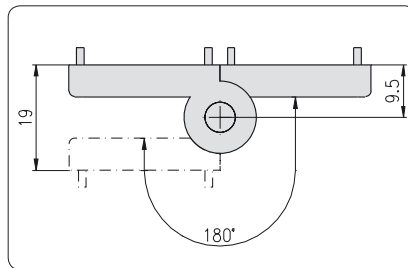
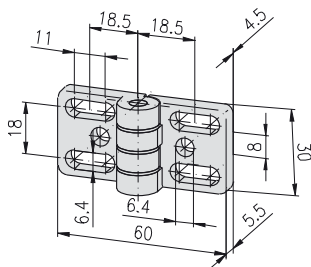

Swivel angle

- 16
- 20
- 30
- 40
- 45
- 50
- 60

Description

Hinge 30×60

Weight

68.8 g

Article-No.

1.62.51030060

**Hinge
40×80**

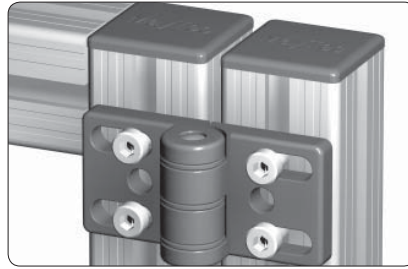

Application

Hinge or higher loads such as doors with profile frames

Technical data

material: GD-Zn
 colour: black
 surface: coated
 max. static load: 750 N

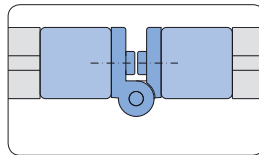

Connection of 2 vertical profiles, all anti-twist safety devices removed

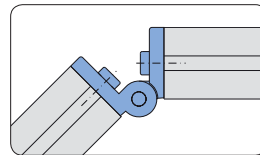

Face-sided connection of 2 profiles, with anti-twist safety device

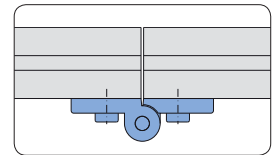

Connection of 2 horizontal profiles, with anti-twist safety device

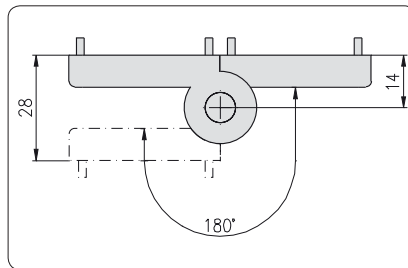
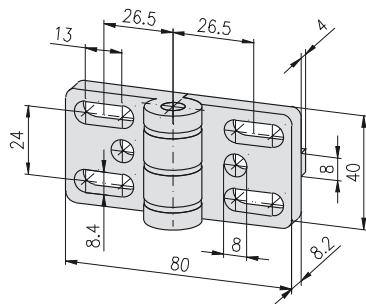

Swivel angle

- 16
- 20
- 30
- 40
- 45
- 50
- 60

Description

Hinge 40×80

Weight

180 g

Article-No.

1.62.520

**Hinges
40×80**



Application

Hinge or higher loads such as doors with profile frames

Technical data

material: GD-Zn
 colour: black
 surface: powder-coated
 max. static load: 750 N

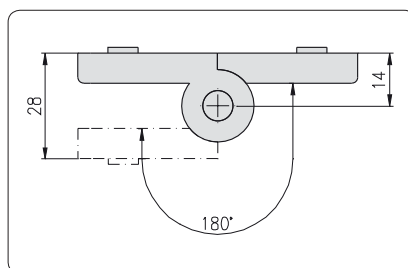

Swivel angle

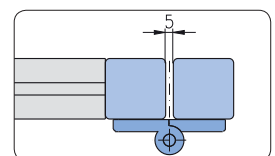

Connection of 2 vertical profiles

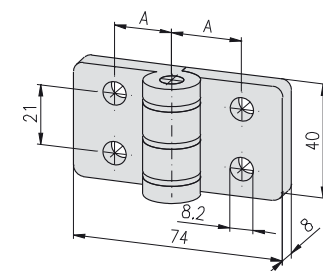

Fastening elements:

- PG 40: T-Nut for subs. insertion E, M8 1.32.4EM8
- PG 45: T-Nut E, M8 1.32.EM8
- PG 40/45: Threaded plate E, M8 1.31.EM8

Description

- Hinge 40×80 for PG 40
- Hinge 40×80 for PG 45

A

- 22.5
- 25.0

Weight

- 194 g
- 194 g

Article-No.

- 1.62.53045
- 1.62.53050

- 16
- 20
- 30
- 40
- 45
- 50
- 60

Hinges

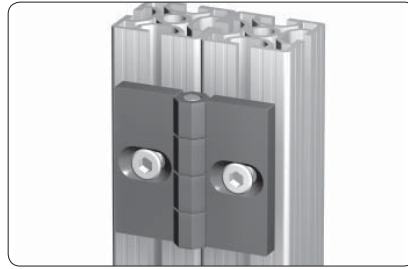

Application

Hinge with detachable fixing plug for different slot distances

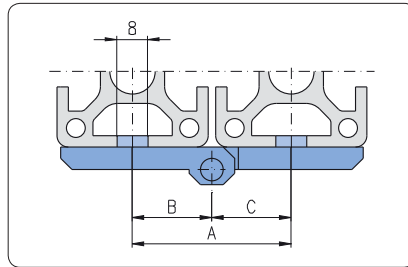

Doors with profile frames

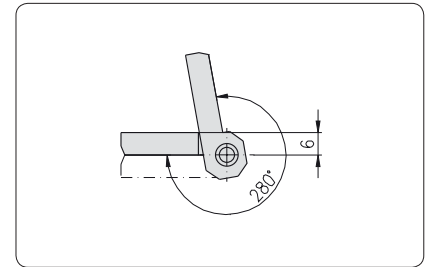

Swivel angle

Technical data

material: GD-Zn
 surface: coated
 colour: black
 max. static load: 250 N

Comments

Countersink DIN 74 - M6 for
 countersunk screw DIN 7991 - M6

Delivery unit

Including 4 plugs for F- and E-slot

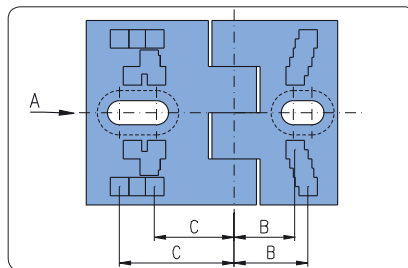

Distances for positioning plugs

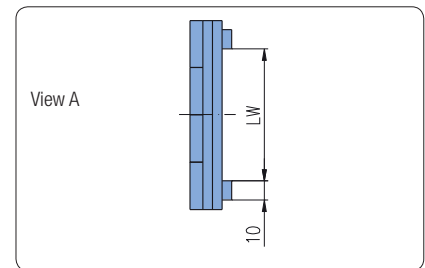

Possibilities of fastening

Legend

LW = width
 G = threaded plate 1.31.□□□
 T = T-Nut 1.32.4□□

		short flange					
		slots					
		F		E3		E4	
B	LW	G	T	G	T	G	T
16.5	11	-	-	x	-	x	x
17.5	14.75	x	x	x	-	x	x
18.5	20.5	x	x	x	x	x	x
19	25.25	x	x	x	x	x	x
20	30	x	x	x	x	x	x

		long flange					
		slots					
		F		E3		E4	
C	LW	G	T	G	T	G	T
21	11	-	-	x	-	x	x
21.5	30	x	x	x	x	x	x
23.5	19	x	x	x	-	x	x
26	30	x	x	x	x	x	x
27.5	11	-	-	x	-	x	x
31	30	x	x	x	x	x	x

Hinge 50x56

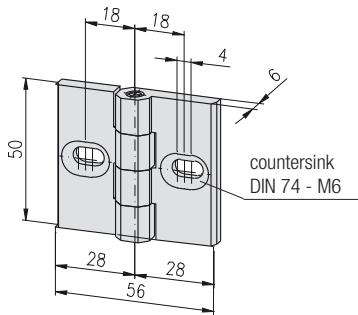

- 16 20 30 40 45 50 60

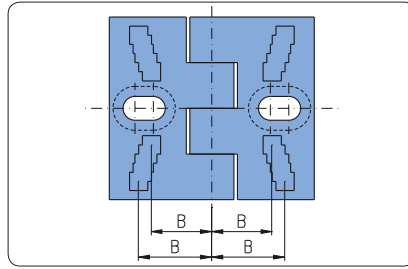

Rear view: plug assignment

2 short flanges

B
16.5
17.5
18.5
19
20

Description

Hinge 50x56

Weight

112 g

Article-No.

1.62.65056

Hinge 50x68

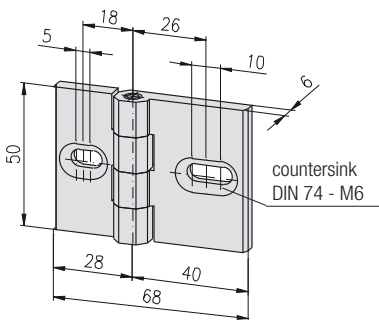

- 16 20 30 40 45 50 60

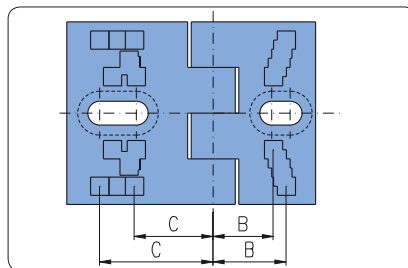

Rear view: plug assignment

1 short flange, 1 long flange

B	C
16.5	21
17.5	21.5
18.5	23.5
19	26
20	27.5
	31

Description

Hinge 50x68

Weight

130 g

Article-No.

1.62.65068

Hinge 50x80

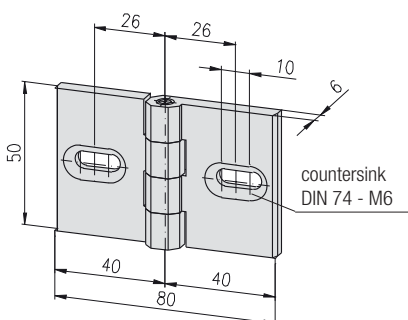

- 16 20 30 40 45 50 60

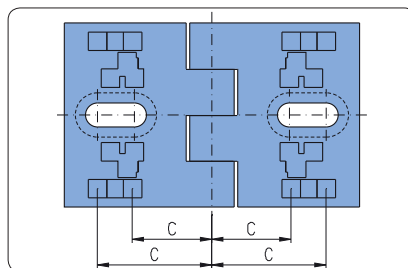

Rear view: plug assignment

2 long flanges

C
21
21.5
23.5
26
27.5
31

Description

Hinge 50x80

Weight

130 g

Article-No.

1.62.65080

Alu hinges

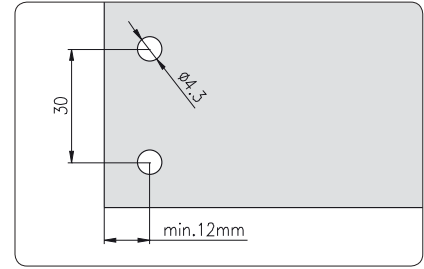

Distance of drill holes for panel elements of acrylic glass

Application

For doors of light material with or without profile frame, each hinge element can be combined

Technical data

material: aluminium Al Mg Si 0.5
 strength: F 25
 surface: natural anodised
 max. static load: 100 N

Comments

Countersink DIN 74 - M4 for
 countersunk screw DIN 7991 - M4
 raw finish on request

Type A

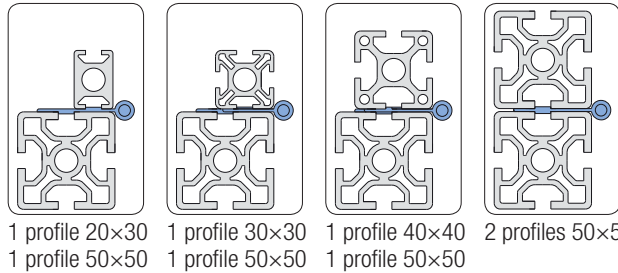

Connection:

- profile to profile
- leg built-in covered
- hinge elements:
Type A
Type A

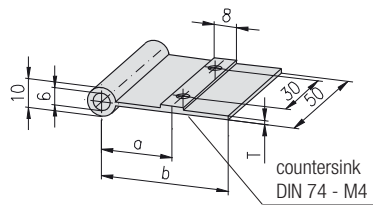

Description	T	a	b	Weight	Article-No.
Hinge element Type A, PG 20, F	1.5	15.3	21	10 g	1.62.7120
Hinge element Type A, PG 30	1.5	20.3	29	11 g	1.62.7130
Hinge element Type A, PG 30	3.0	20.3	29	15 g	1.62.7130.030
Hinge element Type A, PG 40	1.5	25.3	37	13 g	1.62.7140
Hinge element Type A, PG 40	3.0	25.3	37	19 g	1.62.7140.030
Hinge element Type A, PG 50	1.5	30.3	45	14 g	1.62.7150
Hinge element Type A, PG 50	3.0	30.3	45	21 g	1.62.7150.030

Type B

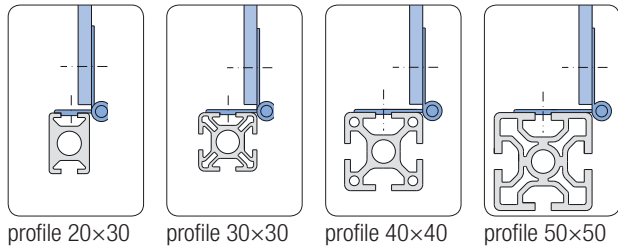

Connection:

- profile to panel element
- leg one side visible
- hinge elements:
Type A
Type B

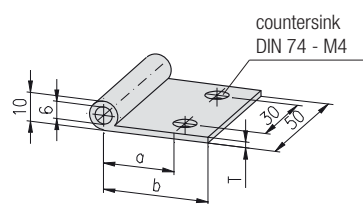

Description	T	a	b	Weight	Article-No.
Hinge element Type B, PG 20	2.0	15.3	21	11 g	1.62.7220
Hinge element Type B, PG 20	3.0	15.3	21	13 g	1.62.7220.030
Hinge element Type B, PG 30	2.0	20.3	29	11 g	1.62.7230
Hinge element Type B, PG 30	3.0	20.3	29	13 g	1.62.7230.030
Hinge element Type B, PG 40	2.0	25.3	37	13 g	1.62.7240
Hinge element Type B, PG 40	3.0	25.3	37	16 g	1.62.7240.030
Hinge element Type B, PG 50	2.0	30.3	45	14 g	1.62.7250
Hinge element Type B, PG 50	3.0	30.3	45	18 g	1.62.7250.030

Type C

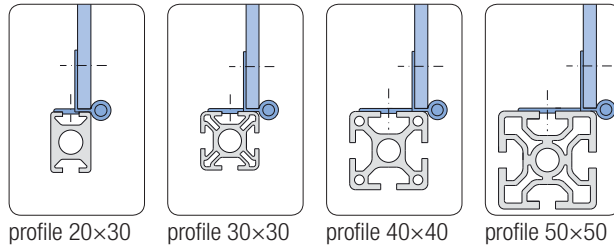

Connection:

- Profile to panel element
- leg built-in covered
- hinge elements:
Type A
Type C

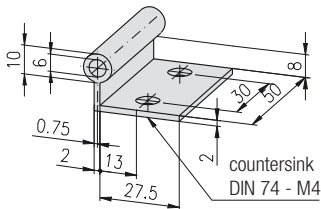

Description

Hinge element Type C, 30 mm

Weight

15 g

Article-No.

1.62.7330

Press-fit pins
for alu hinges



Press-fit pin for one sided installation

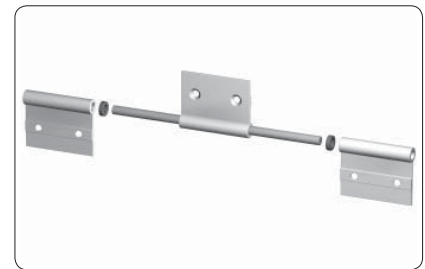

Press-fit pin for two sided installation

Technical data

material: steel
surface: galvanised

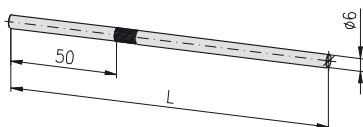

Description

Description	L
Press-fit pin Ø6	100
Press-fit pin Ø6	150

Weight

29 g
33 g

Article-No.

1.62.7910
1.62.7915

Spacer

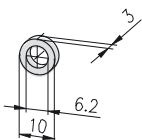

Technical data

material: PE
colour: black

Description

Spacer

Weight

1 g

Article-No.

1.62.7810

Alu hinges, heavy



Application

Hinge for higher loads such as doors with profile frames

Technical data

hinge material: aluminium
 strength: F25
 surface: natural anodised
 bolt material: steel
 stainless steel

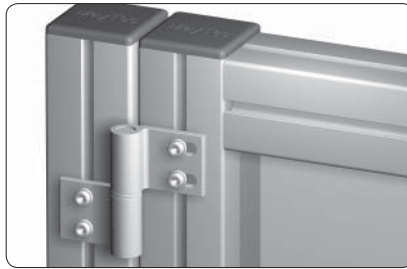

Comments

Countersink DIN 74 - M8 for
 countersunk screw DIN 7991 - M8
 raw finish on request

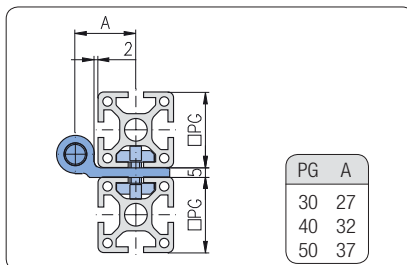

Application: Type 20

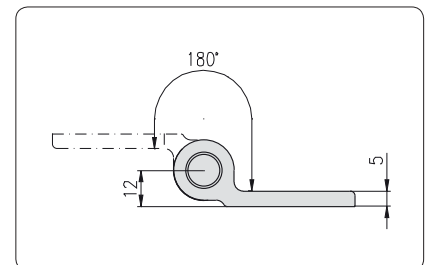

Swivel angle: Type 20

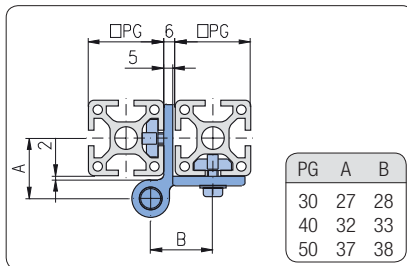

Application: Type 21, 22, 23, 31
 with profiles PG 40/50

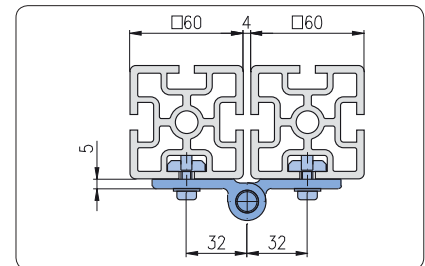

Application: Type 21, 22, 23, 31
 with profiles PG 60

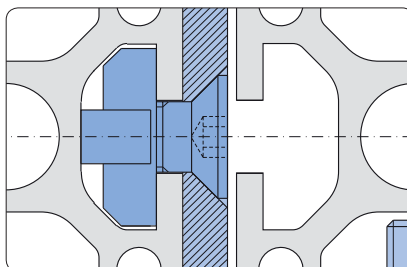

Application: Type 21, 22, 23, 31
 with profiles PG 30/40/50

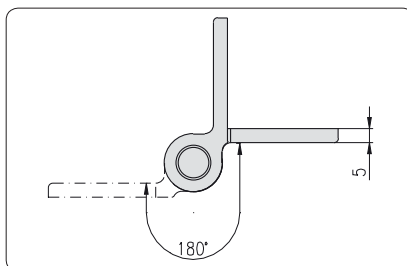

Swivel angle: Type 21, 22, 23, 31
 at application with profiles PG 30/40/50

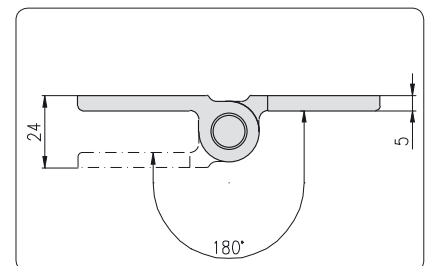

Swivel angle: Type 21, 22, 23, 31
 at application with profiles PG 60

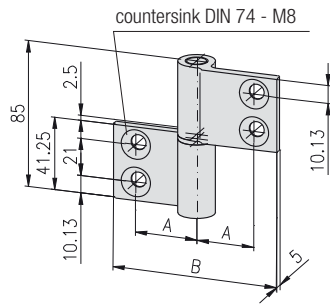

Description	Bolt	A	B	Weight	Article-No.
Alu hinge, heavy, type 20, PG 30	steel	27	78	130 g	1.62.842027085
Alu hinge, heavy, type 20, PG 40	steel	32	100	166 g	1.62.842032085
Alu hinge, heavy, type 20, PG 50	steel	37	100	166 g	1.62.842037085
Alu hinge, heavy, type 20, PG 30	stainless	27	78	130 g	1.62.842027085V
Alu hinge, heavy, type 20, PG 40	stainless	32	100	166 g	1.62.842032085V
Alu hinge, heavy, type 20, PG 50	stainless	37	100	166 g	1.62.842037085V

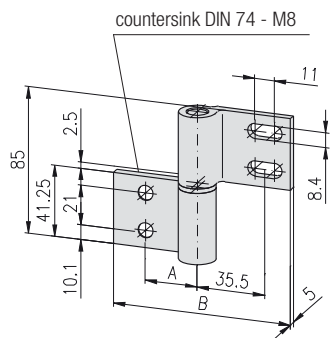

Description	Bolt	A	B	Weight	Article-No.
Alu hinge, heavy, type 21, PG 30/30-50	steel	27	89	123 g	1.62.842127085
Alu hinge, heavy, type 21, PG 40/40-50	steel	32	100	159 g	1.62.842132085
Alu hinge, heavy, type 21, PG 50	steel	37	100	159 g	1.62.842137085
Alu hinge, heavy, type 21, PG 30/30-50	stainless	27	89	123 g	1.62.842127085V
Alu hinge, heavy, type 21, PG 40/40-50	stainless	32	100	159 g	1.62.842132085V
Alu hinge, heavy, type 21, PG 50	stainless	37	100	159 g	1.62.842137085V

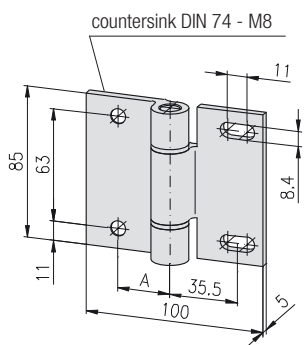

Description	Bolt	A	Weight	Article-No.
Alu hinge, heavy, type 22, PG 40/40-50	steel	32	261 g	1.62.842232085
Alu hinge, heavy, type 22, PG 50	steel	37	261 g	1.62.842237085
Alu hinge, heavy, type 22, PG 40/40-50	stainless	32	261 g	1.62.842232085V
Alu hinge, heavy, type 22, PG 50	stainless	37	261 g	1.62.842237085V

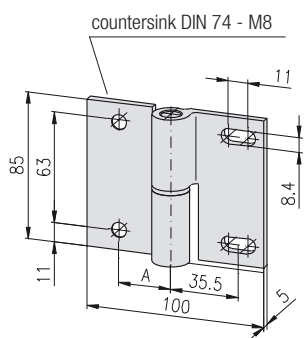

Description	Bolt	A	Weight	Article-No.
Alu hinge, heavy, type 23, PG 40/40-50	steel	32	258 g	1.62.842332085
Alu hinge, heavy, type 23, PG 50	steel	37	258 g	1.62.842337085
Alu hinge, heavy, type 23, PG 40/40-50	stainless	32	258 g	1.62.842332085V
Alu hinge, heavy, type 23, PG 50	stainless	37	258 g	1.62.842337085V

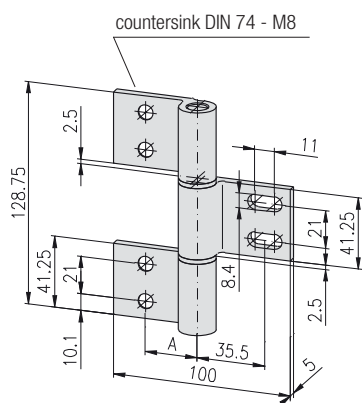

Description	Bolt	A	Weight	Article-No.
Alu hinge, heavy, type 31, PG 40/40-50	steel	32	245 g	1.62.843132128
Alu hinge, heavy, type 31, PG 50	steel	37	245 g	1.62.843137128
Alu hinge, heavy, type 31, PG 40/40-50	stainless	32	245 g	1.62.843132128V
Alu hinge, heavy, type 31, PG 50	stainless	37	245 g	1.62.843137128V

Joints
with / without clamping lever

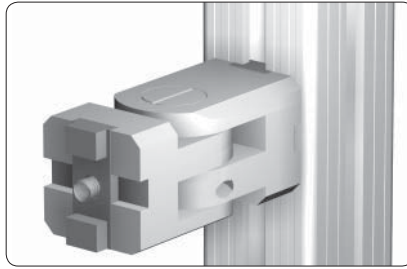

The MayTec clamping system allows backlash free adjusting and clamping

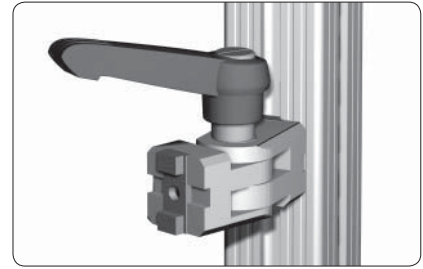

The joint can be locked with the adjustable clamping lever

Application

To enable infinitely variable adjusting and swivelling of profiles

Technical data

material: steel
surface: galvanised

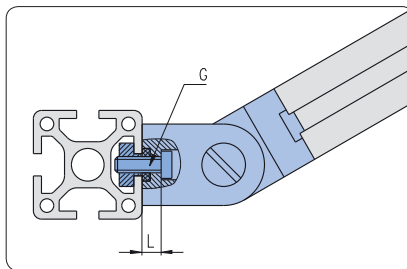

Mounting on profile side

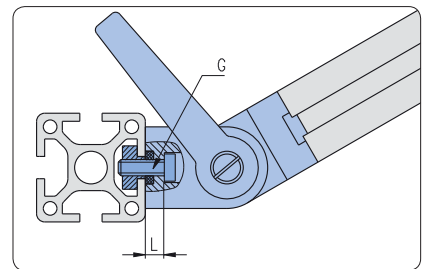

Mounting on profile side

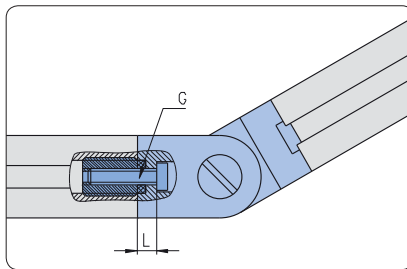

Mounting on profile end

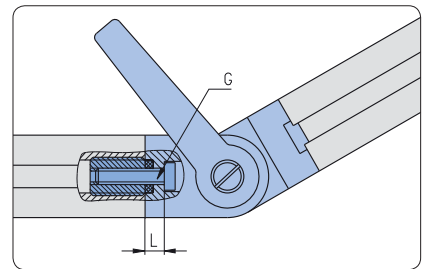

Mounting on profile end

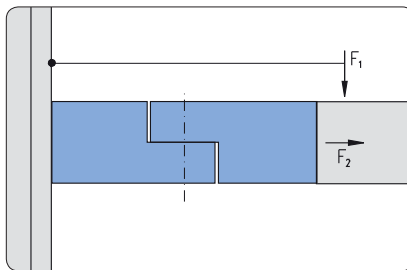

Joint	max. loads	
	F1 _{max}	F2 _{max}
20×20	10 Nm	2,000 N
30×30	30 Nm	4,000 N
30×50	50 Nm	4,000 N
30×100	100 Nm	8,000 N
30×100 ¹⁾	200 Nm	8,000 N
40×40	50 Nm	6,000 N
50×50	60 Nm	10,000 N

¹⁾ with fastening plate

Comments

- Mounting with:
- cap-screw DIN 6912
 - washer DIN 433

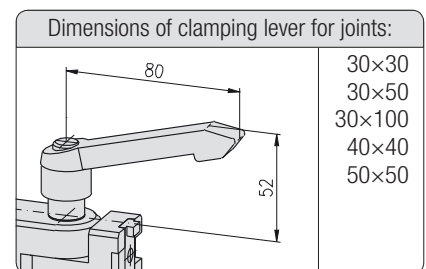
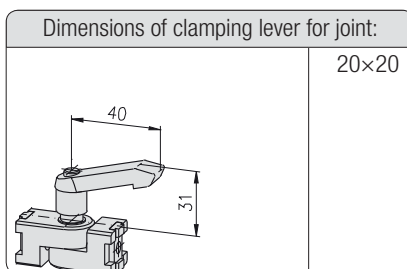

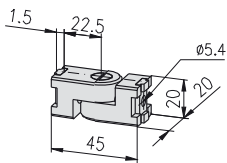
20×20

Description	G	L	Weight	Article-No.
Joint 20×20	M5	6.5	97 g	1.63.02021
Joint 20×20 with clamping lever	M5	6.5	114 g	1.63.12021
Anti-twist device for joint, H, L20			8 g	1.63.02022
Anti-twist device for joint, F, L20			8 g	1.63.02023

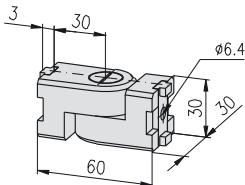
30×30

Description	G	L	Weight	Article-No.
Joint 30×30	M6	7.5	315 g	1.63.03031
Joint 30×30 with clamping lever	M6	7.5	380 g	1.63.13031
Anti-twist device for joint, L30			28 g	1.63.03032

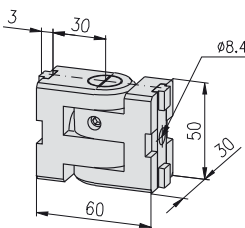
30×50

Description	G	L	Weight	Article-No.
Joint 30×50	M8	7.5	533 g	1.63.03051
Joint 30×50 with clamping lever	M8	7.5	600 g	1.63.13051
Anti-twist device for joint, L30			28 g	1.63.03032
Anti-twist device for joint, L50			33 g	1.63.03052

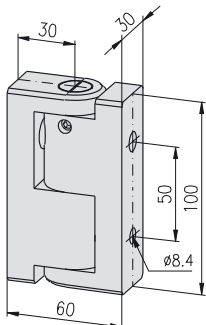
30×100

Comments

To increase the load capacity on hinge 30×100
 ➔ fastening plate 30×150, 1.47.60315

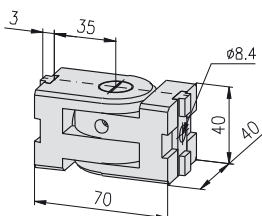
Description	G	L	Weight	Article-No.
Joint 30×100	M8	7.5	1,098 g	1.63.03101
Joint 30×100 with clamping lever	M8	7.5	1,160 g	1.63.13101

40×40

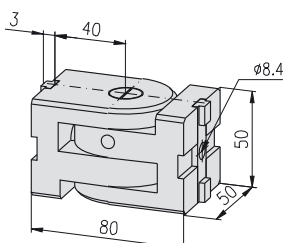
Description	G	L	Weight	Article-No.
Joint 40×40	M8	7.5	674 g	1.63.04041
Joint 40×40 with clamping lever	M8	7.5	739 g	1.63.14041
Anti-twist device for joint, L40			28 g	1.63.04042

50×50

Description	G	L	Weight	Article-No.
Joint 50×50	M8	7.5	1,244 g	1.63.05051
Joint 50×50 with clamping lever	M8	7.5	1,300 g	1.63.15051
Anti-twist device for joint, L50			33 g	1.63.03052

Joints Zn
with / without clamping lever



The MayTec clamping system allows backlash free adjusting and clamping

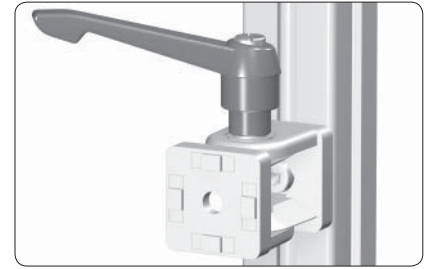

The joint can be locked with the adjustable clamping lever

Application

To enable infinitely variable adjusting and swivelling of profiles

Technical data

material: GD-Zn
surface: aluminium coloured powder-coated

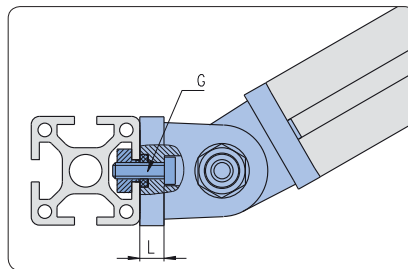

Mounting on profile side

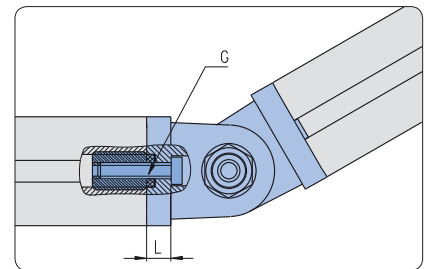

Mounting on profile end

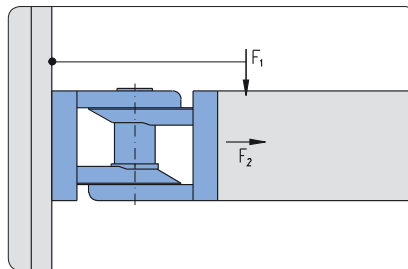

max. loads		
Joint	F1 _{max}	F2 _{max}
30×30	500 N	500 N
40×40	750 N	750 N
45×45	750 N	750 N

Comments

- Mounting with:
- cap screw DIN 6912
 - washer DIN 433

30×30

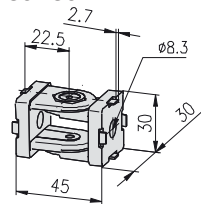

40×40

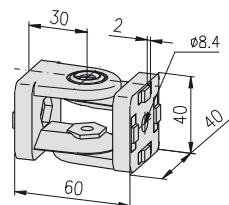

45×45

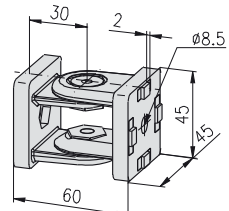

Description

Description	G	L	Weight	Article-No.
Joint Zn 30×30	M8	7.0	124 g	1.63.51030030
Joint Zn 30×30 with clamping lever	M8	7.0	147 g	1.63.52030030

Description

Description	G	L	Weight	Article-No.
Joint Zn 40×40	M8	9.0	300 g	1.63.51040040
Joint Zn 40×40 with clamping lever	M8	9.0	344 g	1.63.52040040

Description

Description	G	L	Weight	Article-No.
Joint Zn 45×45	M8	8.0	320 g	1.63.51045045
Joint Zn 45×45 with clamping lever	M8	8.0	366 g	1.63.52045045

**Mounting blocks
screw-type**

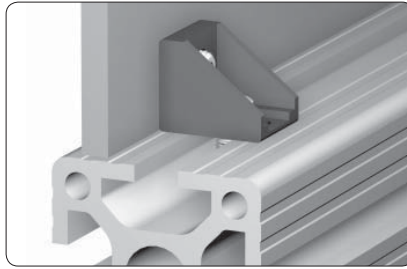

Application

For mounting of panels

Technical data

Mounting block
material: PA-GF
colours: grey, black
Threaded plate
material: steel
surface: galvanised

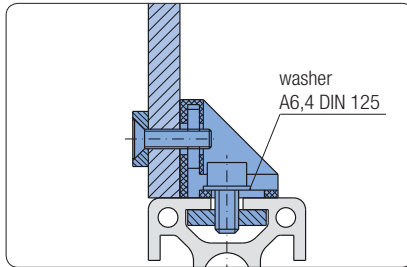

Mounting on the profile with threaded plate or T-Nut

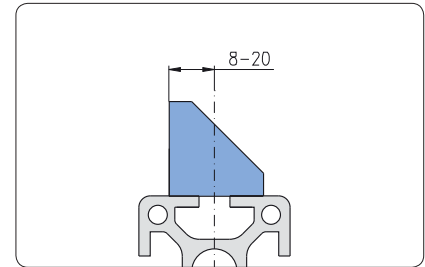

Adjustable position

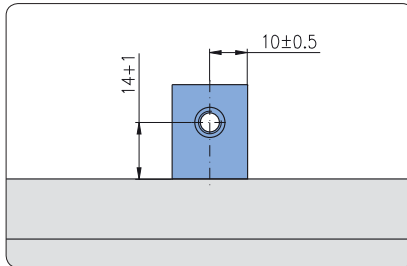

Comments

A 'floating' nut allows additional tolerance in the panel mounting holes.

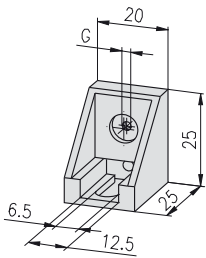

Description	G	Colour	Weight	Article-No.
Mounting block screw type	M3	grey	9 g	1.64.10M3.1
Mounting block screw type	M3	black	9 g	1.64.10M3.2
Mounting block screw type	M4	grey	9 g	1.64.10M4.1
Mounting block screw type	M4	black	9 g	1.64.10M4.2
Mounting block screw type	M5	grey	9 g	1.64.10M5.1
Mounting block screw type	M5	black	9 g	1.64.10M5.2
Mounting block screw type	M6	grey	9 g	1.64.10M6.1
Mounting block screw type	M6	black	9 g	1.64.10M6.2

Mounting block GD-Zn

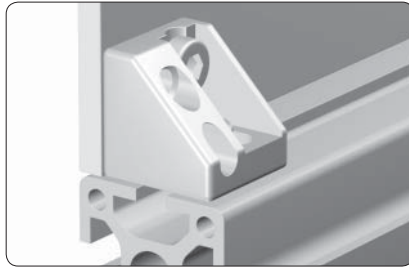

Application
For mounting of panels

Technical data
material: GD-Zn

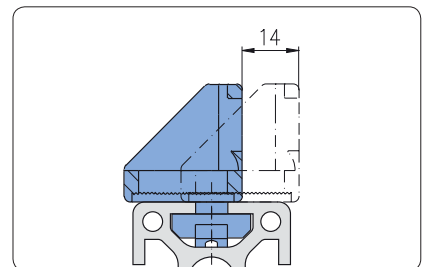
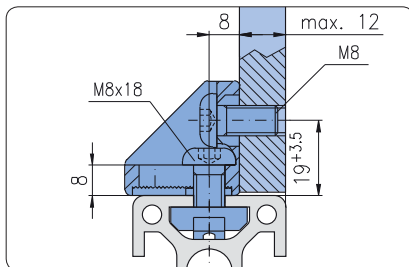
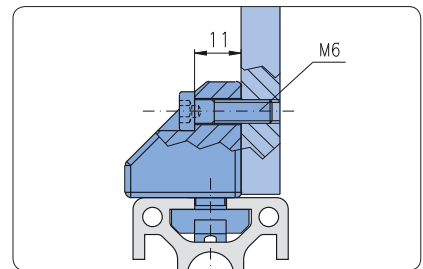
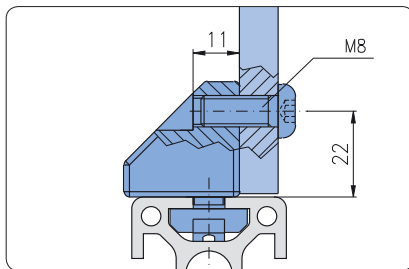
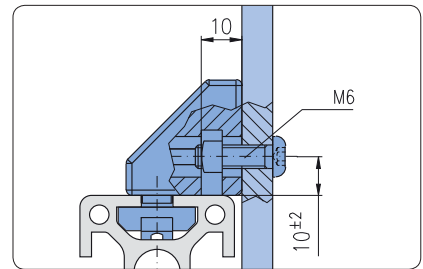
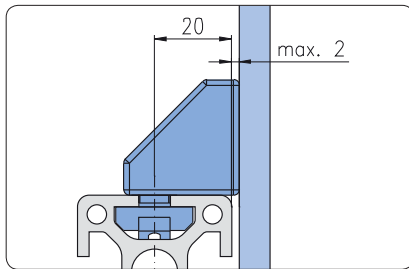

Anti-twistable mounting in steps of 1 mm

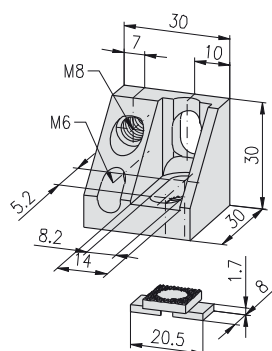
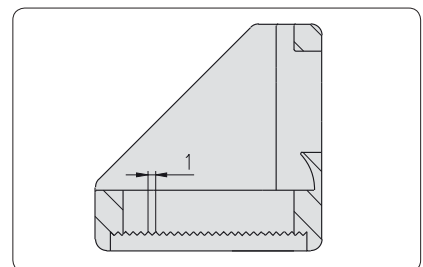

Description	G	Surface	Weight	Article-No.
Mounting block GD-Zn	M8	natural	68 g	1.64.153030.1
Mounting block GD-Zn	M8	black	68 g	1.64.153030.2

Mounting blocks for subsequent insertion

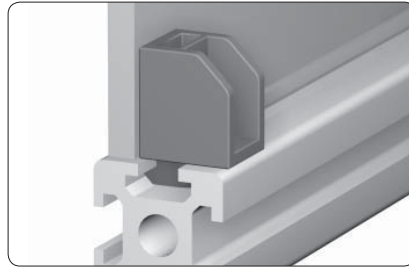

Application

For the mounting of panels with subsequent insertion
Variable mounting position of panels with distancing plate

Mounting block H

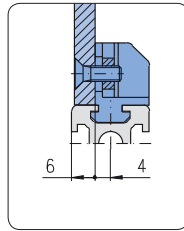
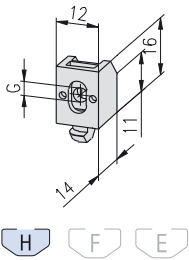

H-slot

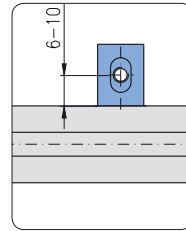

Tolerance equalisation: 4 mm

Technical data

material: PA-GF
colour: black
square nut: steel, galvanised
max. static load: 100 N, rectangular to slot

Description	G	Weight	Article-No.
Mounting block H	M4	2.6 g	1.64.2H2M4.2

Technical data

material: PA-GF
colour: black

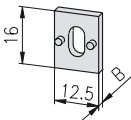

Description	B	Weight	Article-No.
Distancing plate for mounting block H	1	0.2 g	1.64.xH01
Distancing plate for mounting block H	2	0.4 g	1.64.xH02
Distancing plate for mounting block H	3	0.6 g	1.64.xH03
Distancing plate for mounting block H	4	0.8 g	1.64.xH04

Mounting blocks F and E

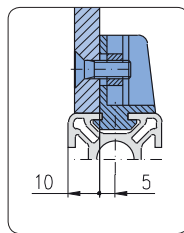

F-slot

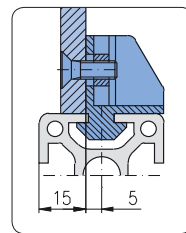

E3-slot

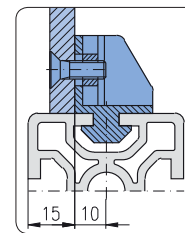

E4-slot

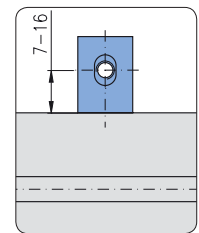

Tolerance equalisation: 9 mm

Technical data

material: PA-GF
colours: grey, black
square nut: steel, galvanised
max. static load: 250 N, rectangular to slot

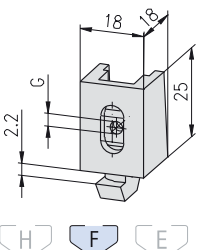

Description	G	Colour	Weight	Article-No.
Mounting block F	M4	grey	9 g	1.64.2F2M4.1
Mounting block F	M4	black	9 g	1.64.2F2M4.2
Mounting block F	M5	grey	9 g	1.64.2F2M5.1
Mounting block F	M5	black	9 g	1.64.2F2M5.2
Mounting block F	M6	grey	9 g	1.64.2F2M6.1
Mounting block F	M6	black	9 g	1.64.2F2M6.2

Mounting blocks E

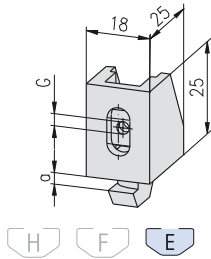

Description	G	Colour	a	Weight	Article-No.
Mounting block E3	M4	grey	3.0	10.5 g	1.64.2E3M4.1
Mounting block E3	M4	black	3.0	10.5 g	1.64.2E3M4.2
Mounting block E3	M5	grey	3.0	10.1 g	1.64.2E3M5.1
Mounting block E3	M5	black	3.0	10.1 g	1.64.2E3M5.2
Mounting block E3	M6	grey	3.0	9.6 g	1.64.2E3M6.1
Mounting block E3	M6	black	3.0	9.6 g	1.64.2E3M6.2
Mounting block E4	M4	grey	4.0	10.6 g	1.64.2E4M4.1
Mounting block E4	M4	black	4.0	10.6 g	1.64.2E4M4.2
Mounting block E4	M5	grey	4.0	10.2 g	1.64.2E4M5.1
Mounting block E4	M5	black	4.0	10.2 g	1.64.2E4M5.2
Mounting block E4	M6	grey	4.0	9.9 g	1.64.2E4M6.1
Mounting block E4	M6	black	4.0	9.9 g	1.64.2E4M6.2

Technical data

material: PA-GF
colours: grey, black

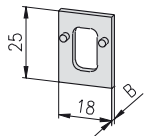

Description	B	Colour	Weight	Article-No.
Distancing plate for mounting block FE	2	grey	0.5 g	1.64.2x02.1
Distancing plate for mounting block FE	2	black	0.5 g	1.64.2x02.2
Distancing plate for mounting block FE	3	grey	0.8 g	1.64.2x03.1
Distancing plate for mounting block FE	3	black	0.8 g	1.64.2x03.2
Distancing plate for mounting block FE	5	grey	1.3 g	1.64.2x05.1
Distancing plate for mounting block FE	5	black	1.3 g	1.64.2x05.2

Distancing plate, thin

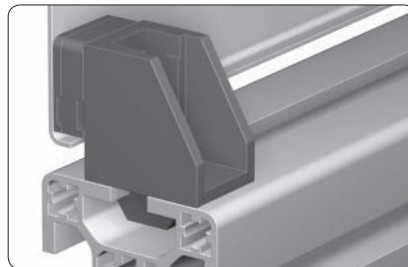

Application

For the mounting of folded panels

Technical data

material: PA-GF
colours: grey, black

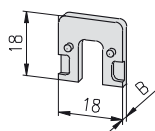
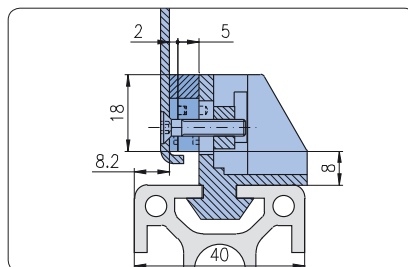

Description	B	Colour	Weight	Article-No.
Distancing plate, thin, for mounting block FE	2	grey	0.3 g	1.64.2x102.1
Distancing plate, thin, for mounting block FE	2	black	0.3 g	1.64.2x102.2
Distancing plate, thin, for mounting block FE	3	grey	0.6 g	1.64.2x103.1
Distancing plate, thin, for mounting block FE	3	black	0.6 g	1.64.2x103.2
Distancing plate, thin, for mounting block FE	5	grey	0.9 g	1.64.2x105.1
Distancing plate, thin, for mounting block FE	5	black	0.9 g	1.64.2x105.2

Mounting clamp blocks for subsequent insertion

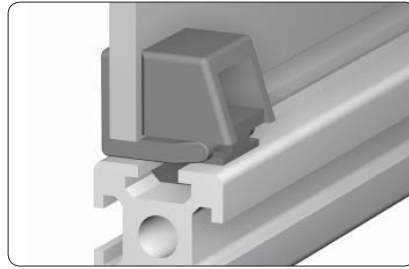

Application

Mounting of panels with clamps, without drilling and screwing
 For subsequent insertion:
 Variable mounting position of panels with distance plates

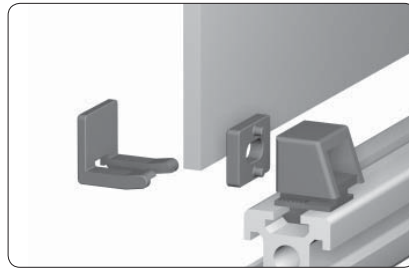

The distance plates are positioned and fastened by pins, it is possible to mount several distance plates in series

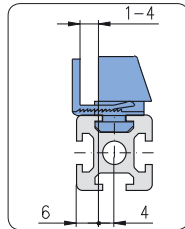

H-slot

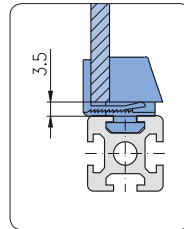

Installation dimensions

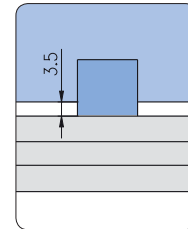

Installation dimensions

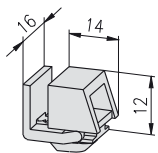

Technical data

material: PA-GF
 colour: black
 max. static load:
 • towards clamp block: 110 N
 • towards slider: 30 N

Description

Mounting clamp block H

Weight

3.4 g

Article-No.

1.64.3H2

Technical data

material: PA-GF
 colour: black

Description

Description	B	Weight	Article-No.
Distancing plate for mounting clamp block H	1	0.2 g	1.64.xH01
Distancing plate for mounting clamp block H	2	0.4 g	1.64.xH02
Distancing plate for mounting clamp block H	3	0.6 g	1.64.xH03
Distancing plate for mounting clamp block H	4	0.8 g	1.64.xH04

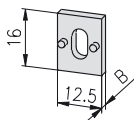

Mounting clamp blocks for subsequent insertion

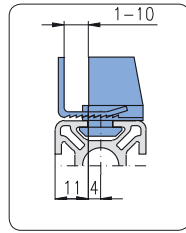

F-slot

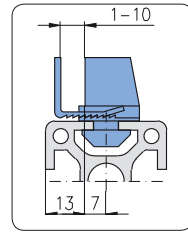

E3-slot

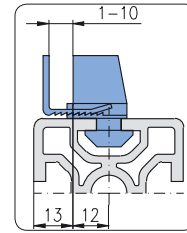

E4-slot

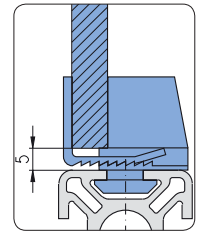

Installation dimensions

Technical data

material: PA-GF

colour: black

max. static load:

- towards clamp block: 250 N
- towards slider: 50 N

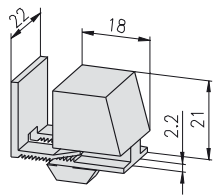

Description

Mounting clamp block F

Weight

7.5 g

Article-No.

1.64.3F2

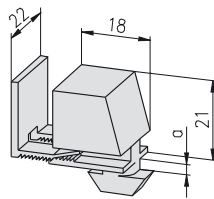

Description

Mounting clamp block E3

a

3.0

Weight

8.0 g

Article-No.

1.64.3E3

Mounting clamp block E4

4.0

8.0 g

1.64.3E4

Technical data

material: PA-GF

colour: black

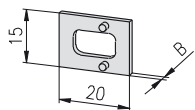

Description

Distancing plate for mounting clamp block FE

B

2

Weight

0.6 g

Article-No.

1.64.3x02

Distancing plate for mounting clamp block FE

3

0.9 g

1.64.3x03

Distancing plate for mounting clamp block FE

5

1.4 g

1.64.3x05

Mounting clamp blocks SL for subsequent insertion

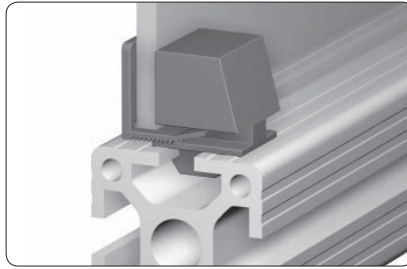

Application

As mounting clamp block, however: For safety's sake it is only possible to be opened with special tools

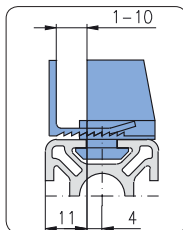
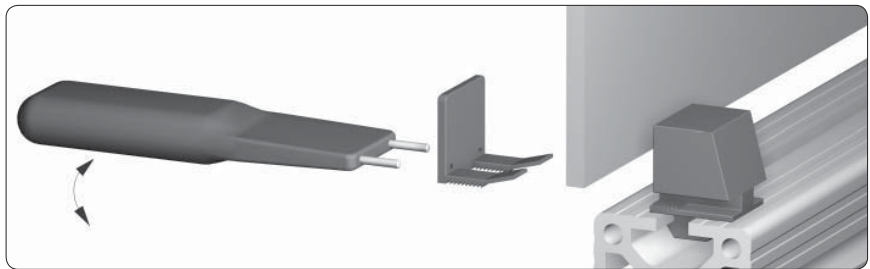

F-slot

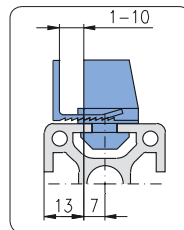

E3-slot

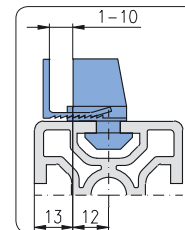

E4-slot

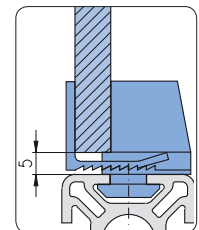

Installation dimensions

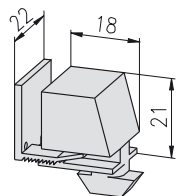

Technical data

- material: PA-GF
- colour: black
- max. static load:
 - towards clamp block: 250 N
 - towards slider: 50 N

Description

Description	Weight	Article-No.
Mounting clamp block F, SL	7.5 g	1.64.4F2
Mounting clamp block E3, SL	8.0 g	1.64.4E3
Mounting clamp block E4, SL	8.0 g	1.64.4E4

Technical data

- material: PA-GF
- colour: black

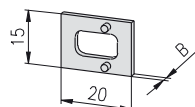

Description

Description	B	Weight	Article-No.
Distancing plate for mounting clamp block FE	2	0.6 g	1.64.3x02
Distancing plate for mounting clamp block FE	3	0.9 g	1.64.3x03
Distancing plate for mounting clamp block FE	5	1.4 g	1.64.3x05

Technical data

- material: PA-GF
- colour: red
- steel bolt: hardened

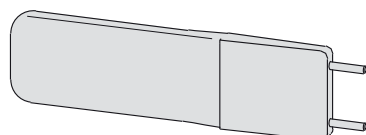

Description

Description	Weight	Article-No.
Tool for mounting clamp block SL	23 g	1.64.4W

Quick locks

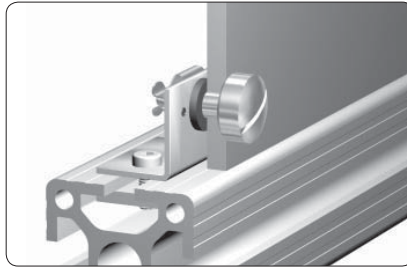

Application

Mounting element for quick mounting and dismounting of covers

Comments

open: by 1/4-turn
close: by push in

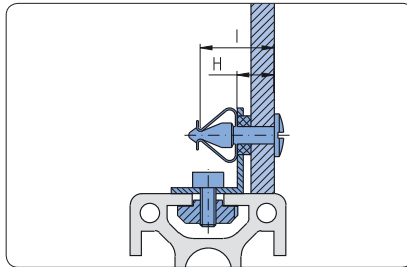

Fastening without washer
 $H_{max} = S_{retaining\ ring} + \text{panel thickness}$

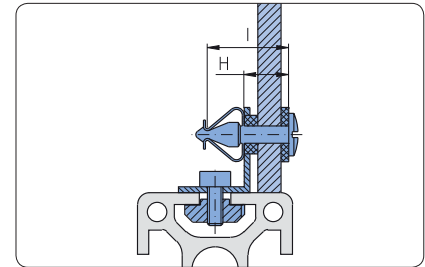

Fastening with washer
 $H_{max} = S_{retaining\ ring} + \text{panel thickness} + S_{washer}$

Technical data (assembly)

drilling diameter
in the covers: 7 mm
max. static load: 900 N
life time: ca. 10.000 operations

Mounting angle

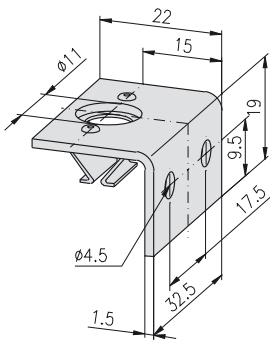

Technical data

material: steel
surface: galvanised

Mounting elements:

- F-slot:
- T-Nut, with leaf spring F, 2xM4 1.32.4F2M4.25
 - threaded plate F, M4 1.31.FM4
 - spring nut F, M4 1.33.FM4
 - T-slot nut F, M4 1.34.10FM4
- E-slot:
- T-Nut, with leaf spring E, 2xM4 1.32.4E2M4.25
 - spring nut E, M4 1.33.EM4
 - T-slot nut E, M4 1.34.10EM4
 - rhomboid T-slot nut E, M4 1.34.20EM4

Description	Weight	Article-No.
Mounting angle	14 g	1.64.5101

Retaining rings

Technical data

material: neoprene
hardness: 55 Shore A
temperature range: - 50°C to + 90°C

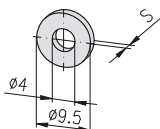

Description	S	Weight	Article-No.
Retaining ring	1.7	1.3 g	1.64.5217
Retaining ring	2.5	1.8 g	1.64.5225
Retaining ring	4.0	3.5 g	1.64.5240
Retaining ring	5.0	4.0 g	1.64.5250
Retaining ring	6.0	4.5 g	1.64.5260

Sealing washers

Technical data

material: neoprene
 hardness: 55 Shore A
 temperature range: - 50°C to + 90°C

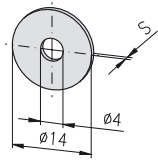

Description	S	Weight	Article-No.
Sealing washer	0.5	0.8 g	1.64.5305
Sealing washer	1.0	1.7 g	1.64.5310
Sealing washer	1.5	2.5 g	1.64.5315
Sealing washer	2.0	3.3 g	1.64.5320

Round head bolts

Technical data

material: brass
 surface: nickel-plated

Comments

Mounting dimension „H“ see mounting sketch

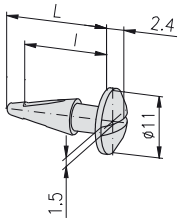

Description	H _{max}	L	I	Weight	Article-No.
Round head bolt	3.7	16.6	14.4	4.0 g	1.64.5416
Round head bolt	4.7	17.6	15.4	4.0 g	1.64.5417
Round head bolt	5.7	18.6	16.4	4.0 g	1.64.5418
Round head bolt	6.9	19.8	17.6	4.5 g	1.64.5419
Round head bolt	7.7	20.6	18.4	5.0 g	1.64.5420
Round head bolt	8.9	21.8	19.6	5.0 g	1.64.5421
Round head bolt	9.7	22.6	20.4	6.0 g	1.64.5422
Round head bolt	10.7	23.6	21.4	6.0 g	1.64.5423

Knurled head bolts

Technical data

material: brass
 surface: nickel-plated

Comments

Mounting dimension „H“ see mounting sketch

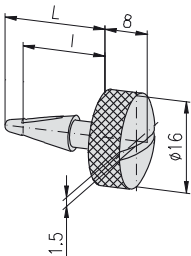

Description	H _{max}	L	I	Weight	Article-No.
Knurled head bolt	3.7	16.6	14.4	14.0 g	1.64.5516
Knurled head bolt	4.7	17.6	15.4	14.0 g	1.64.5517
Knurled head bolt	5.7	18.6	16.4	14.0 g	1.64.5518
Knurled head bolt	6.9	19.8	17.6	14.0 g	1.64.5519
Knurled head bolt	7.7	20.6	18.4	15.0 g	1.64.5520
Knurled head bolt	8.9	21.8	19.6	15.0 g	1.64.5521
Knurled head bolt	10.7	23.6	21.4	15.0 g	1.64.5523

Wing head bolts

Technical data

material: brass
 surface: nickel-plated

Comments

Mounting dimension „H“ see mounting sketch

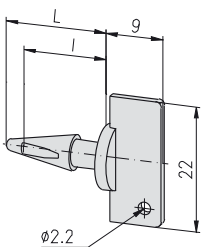

Description	H _{max}	L	I	Weight	Article-No.
Wing head bolt	3.7	16.6	14.4	5.8 g	1.64.5616
Wing head bolt	4.7	17.6	15.4	5.8 g	1.64.5617
Wing head bolt	5.7	18.6	16.4	5.8 g	1.64.5618
Wing head bolt	6.9	19.8	17.6	5.8 g	1.64.5619
Wing head bolt	7.7	20.6	18.4	6.3 g	1.64.5620
Wing head bolt	8.9	21.8	19.6	6.3 g	1.64.5621
Wing head bolt	9.7	22.6	20.4	6.3 g	1.64.5622
Wing head bolt	10.7	23.6	21.4	6.3 g	1.64.5623

Bullet catches

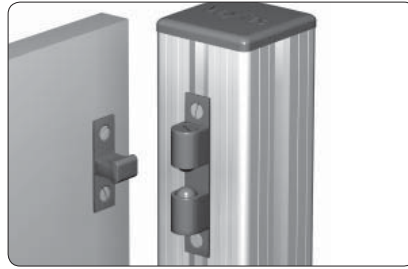

Application

Lock for swinging and sliding doors

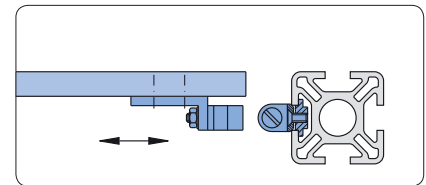
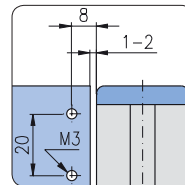
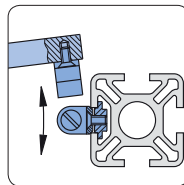

Technical data

material: brass, natural
bullet: stainless steel
retention force: adjustable

Comments

Countersink DIN 74 - M4 for countersunk screw DIN 7991 - M4

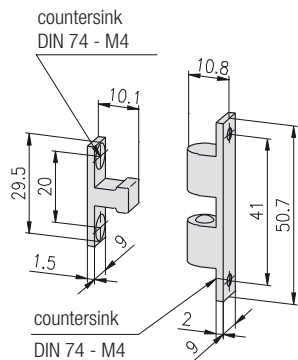

Description

Bullet catch 9x50

Weight

25.0 g

Article-No.

1.65.1101

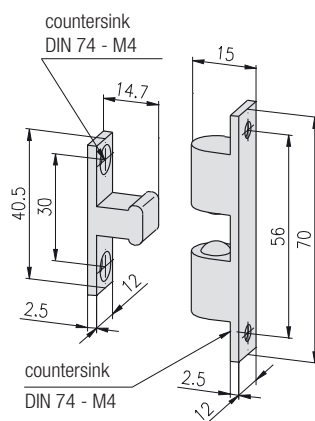

Comments

Countersink DIN 74 - M4 for countersunk screw DIN 7991 - M4

Description

Bullet catch 12x70

Weight

72.0 g

Article-No.

1.65.1102

Bullet catch PA

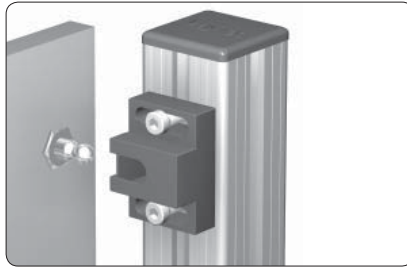

Application

Lock for swinging and sliding doors

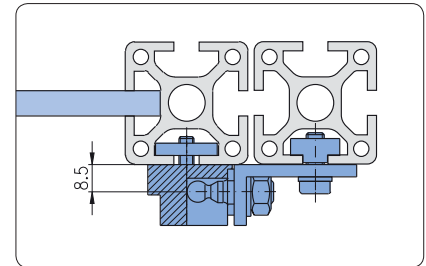
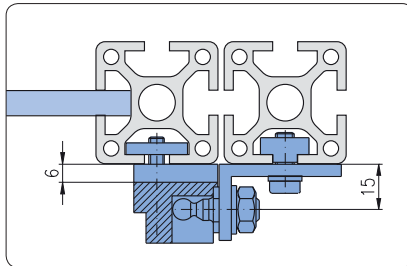
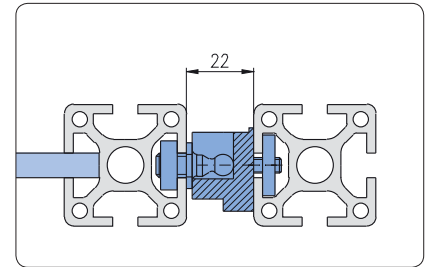
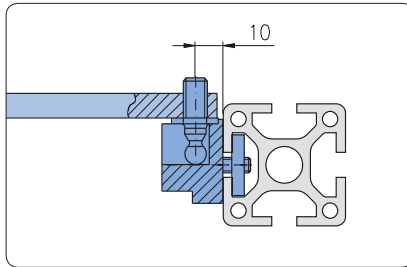

Fastening of the bolt with angle 25×40, Ø8.7 ↗ 1.46.115

Fastening of the bolt with angle 20×47, M8 ↗ 1.65.1301

Bullet catch PA

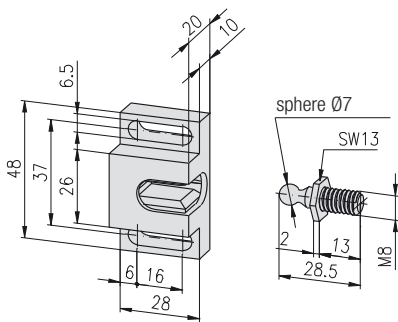

Technical data

capsule: PA-GF, black
 bolt: steel, galvanised
 retention force: 45 N

Description	Weight	Article-No.
Bullet catch PA	23.0 g	1.65.1201

Angle

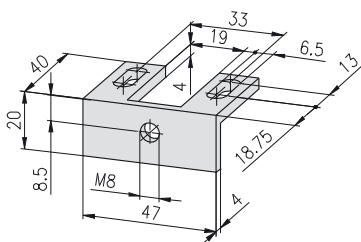

Technical data

material: aluminium
 strength: F22
 surface: natural anodised

Description	Weight	Article-No.
Angle 20×47, M8	16.0 g	1.65.1301

Magnetic lock PA

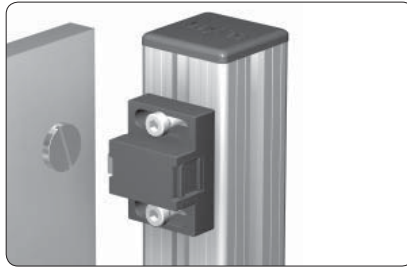

Application

Lock for swinging and sliding doors

Technical data

capsule: PA-GF, black
 flat head screw: steel, galvanised
 retention force: y = 40 N
 x = 25 N

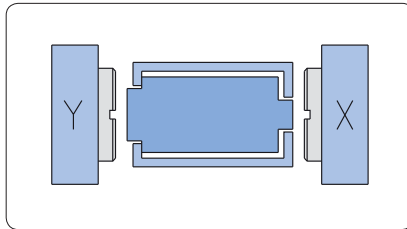

Comments

Different force
 y = large force
 x = small force

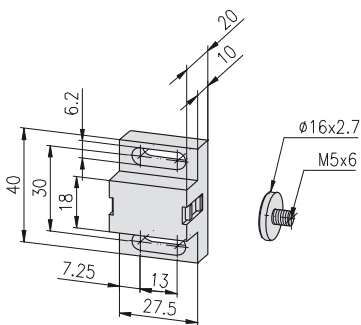
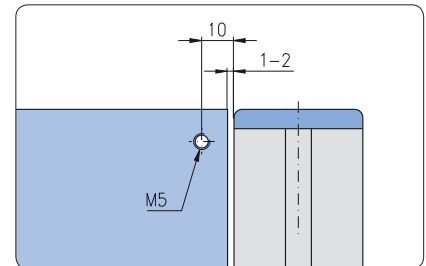
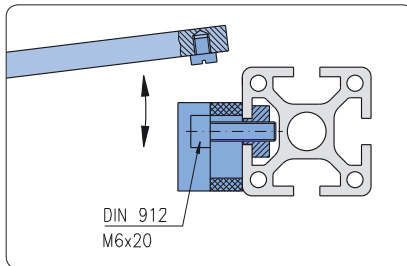

Description

Magnetic lock PA

Weight

38.0 g

Article-No.

1.65.2101

**Angle bracket
 for magnetic lock PA**

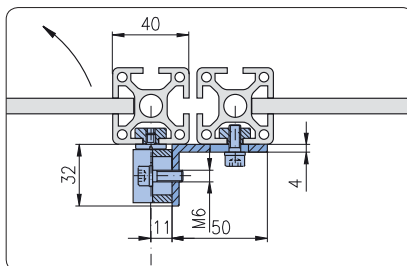

Technical data

material: aluminium
 strength: F22
 surface: natural anodised

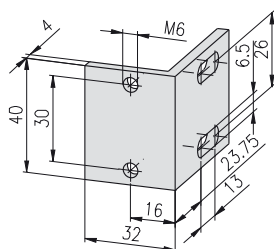

Description

Angle bracket for magnetic lock PA

Weight

32.0 g

Article-No.

1.65.2301

Lock GD-Zn

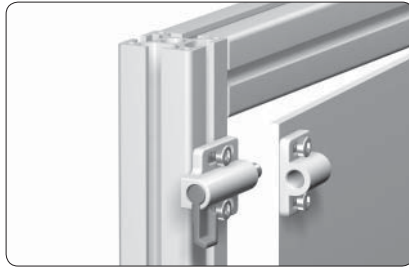

Application

Lock with sprung bolt for easy closing of doors and panels, including separate slot fastening capability

Technical data

capsule: GD Zn, painted silver
 handle: PA, black
 bolt: stainless steel

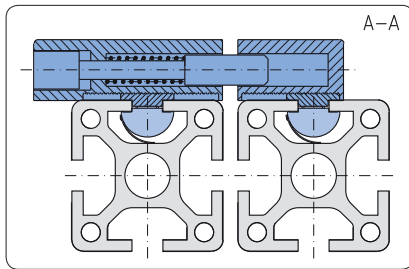

Slot fastening capability

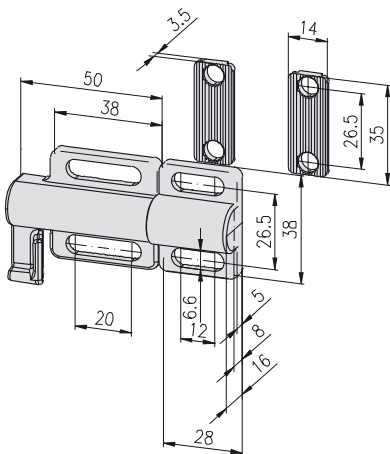
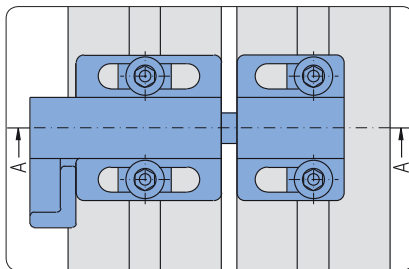

Description

Lock GD-Zn

Weight

120.0 g

Article-No.

1.65.2538078

Cylinder locks

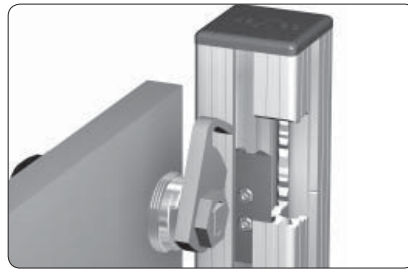

Application

Locking system for swinging and sliding doors

Comments

By turning the lock body the cylinder lock is insertable left or right

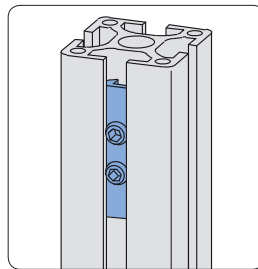

Insertion of the latch

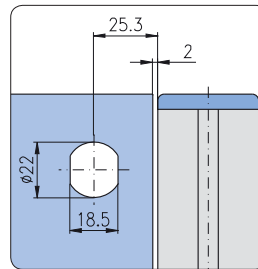

Fixing dimensions for the cylinder lock

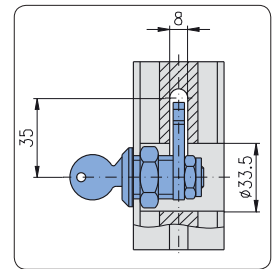

Fixing dimensions for the cylinder lock

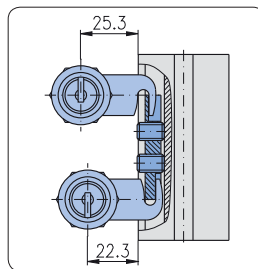

Latch for two different bore spaces

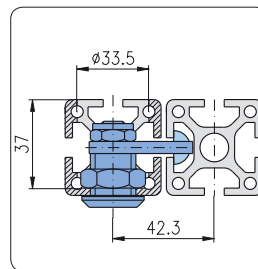

Swinging door with profile frame made of profile 40x40

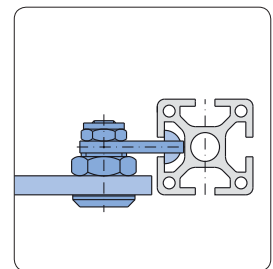

Swinging door without profile frame

Technical data

capsule: GD Zn, galvanised
tongue, nut, screw: steel, galvanised

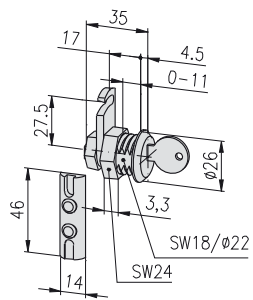

Description

Cylinder lock with 2 keys

Weight

82.0 g

Article-No.

1.65.3101

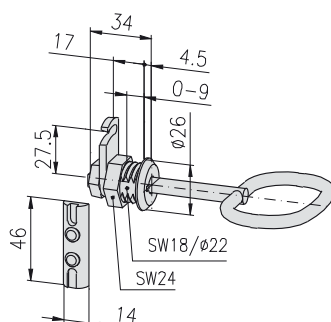

Comments

Key with double beard Ø8 mm

Description

Cylinder lock with double beard insert

Weight

150.0 g

Article-No.

1.65.3102

Cylinder locks with security latch

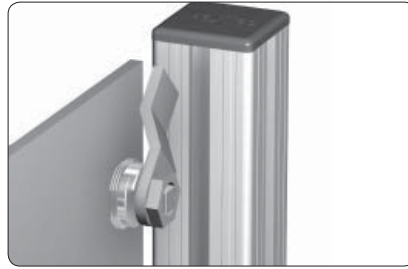

Application
Lock for swinging door

Comments
Security latch
Jolting- and vibrationless by integral lock

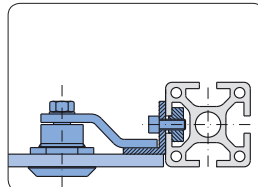

Installation variant with mounting angle

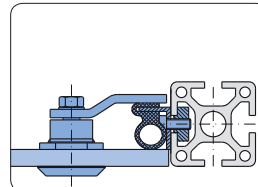

Installation variant with seal

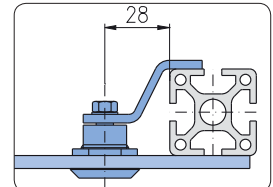

Installation variant

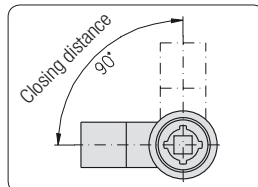

Closing distance

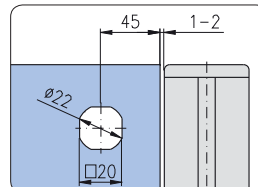

Drilling pattern

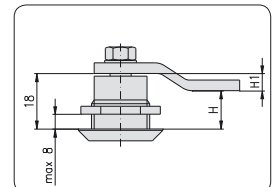

Security latch dimension
H = 18 - H1

Cylinder locks

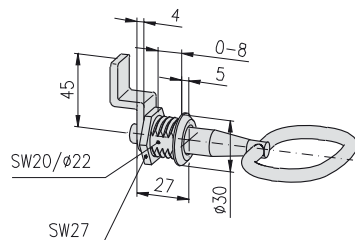
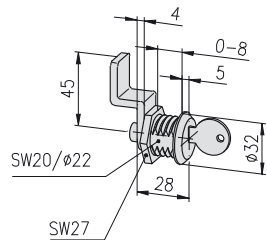

Technical data

capsule: GD Zn, galvanised
tongue, nut, screw: steel, galvanised

Description

Cylinder lock with 2 keys, without security latch

Weight

66 g

Article-No.

1.65.3201

Comments

Socket wrench / square 8 mm

Description

Cylinder lock with 1 square key, without security latch

Weight

100 g

Article-No.

1.65.3202

Security latch

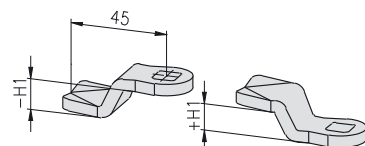

Description

Security latch for cylinder lock

Weight

30 g

Article-No.

1.65.32...

H1	Article-No.	H1	Article-No.	H1	Article-No.	H1	Article-No.
14	1.65.3204	0	1.65.3218	-12	1.65.3230	-24	1.65.3242
12	1.65.3206	-2	1.65.3220	-14	1.65.3232	-26	1.65.3244
10	1.65.3208	-4	1.65.3222	-16	1.65.3234	-27	1.65.3245
8	1.65.3210	-6	1.65.3224	-17	1.65.3235	-29	1.65.3247
5	1.65.3213	-7	1.65.3225	-18	1.65.3236	-32	1.65.3250
4	1.65.3214	-8	1.65.3226	-20	1.65.3238		
2	1.65.3216	-10	1.65.3228	-22	1.65.3240		

Flap-lock countersunk for sliding door

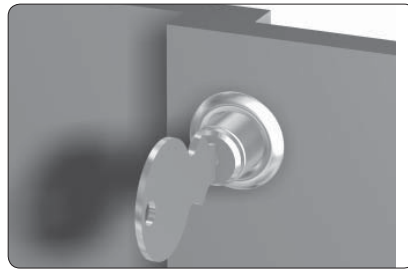

Application
Lock for sliding door

Technical data
capsule: GD Zn, chrome-plated
tongue and nut: steel, galvanised

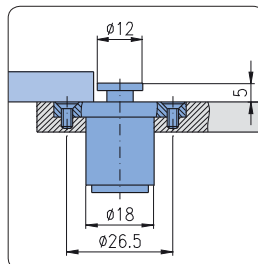
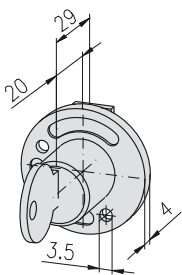

Locked

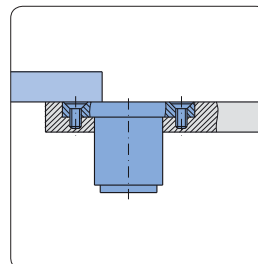

Open

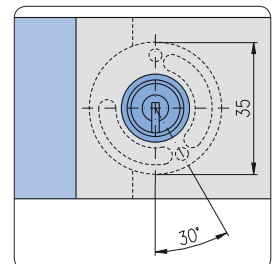

Description	Weight	Article-No.
Flap-lock countersunk, for sliding door	52 g	1.65.3301

Cylinder locks flush

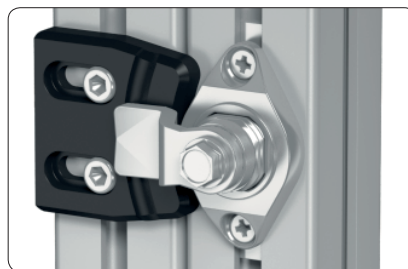

Application
Locking system for swinging doors

Technical data
locking: 90°
material:
• capsule: GD Zn, chrome-plated
• fixing plate: GD Zn, black powder-coated

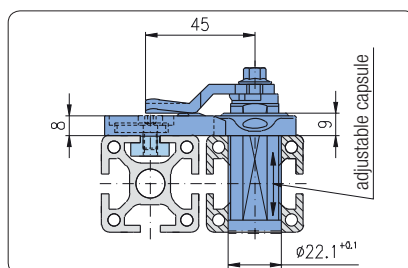

Outside: flush
(without jutout of lock parts)

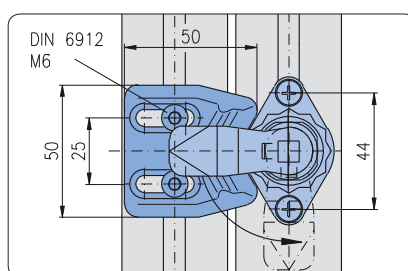
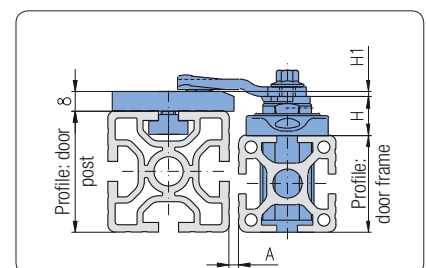

Inside: with fixing plate

Profile		Latch		
Door post	Door frame	A	H	H1
40	40	1.6	16	-8
	45	1.6	16	-2
50	45	1.8	21	-12
	50	2.0	16	-8
	60	3.0	16	-8

Cylinder locks flush

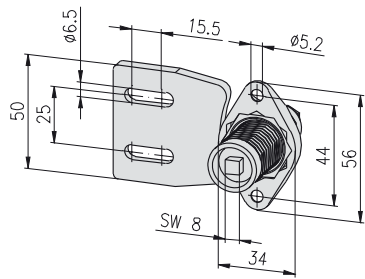

Delivery unit

- cylinder lock with fixing plate

Separate order

- key
- security latch

Description	GL	Weight	Article-No.
Cylinder lock flush, square	56	194.0 g	1.65.34156
Cylinder lock flush, square	66	212.8 g	1.65.34166
Cylinder lock flush, square	76	231.6 g	1.65.34176

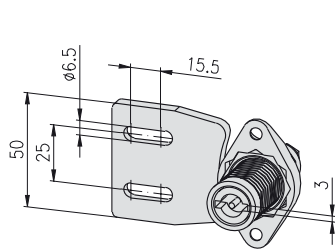

Delivery unit

- cylinder lock with fixing plate

Separate order

- key
- security latch

Description	GL	Weight	Article-No.
Cylinder lock flush, double beard	56	193.8 g	1.65.34356
Cylinder lock flush, double beard	66	204.1 g	1.65.34366
Cylinder lock flush, double beard	76	214.4 g	1.65.34376

Square keys

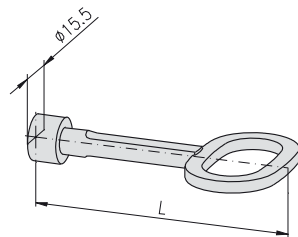

Description	L	Material	Weight	Article-No.
Square key 8, 40 mm		PA-GF	7.5 g	1.65.34540
Square key 8, 81 mm		GD Zn	41.6 g	1.65.34581

Double beard keys

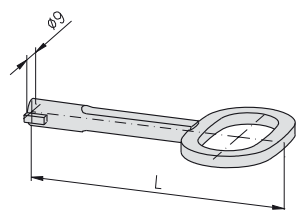

Description	L	Material	Weight	Article-No.
Double beard key 3, 40 mm		PA-GF	6.4 g	1.65.34740
Double beard key 3, 89 mm		GD Zn	35.8 g	1.65.34789

Security latches

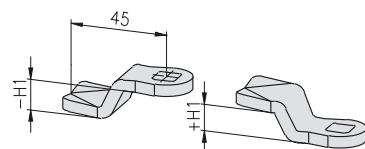

Description	H1	Weight	Article-No.
Security latch 45	12	30.3 g	1.65.3206
Security latch 45	2	26.8 g	1.65.3216
Security latch 45	-2	27.4 g	1.65.3220
Security latch 45	-8	27.3 g	1.65.3226
Security latch 45	-12	30.3 g	1.65.3230

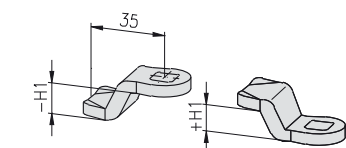

Description	H1	Weight	Article-No.
Security latch 35	2	20.4 g	1.65.3493502.1
Security latch 35	-2	20.1 g	1.65.3493502.2
Security latch 35	-8	22.5 g	1.65.3493508.2
Security latch 35	12	22.9 g	1.65.3493512.1
Security latch 35	-12	22.9 g	1.65.3493512.2

Mortise deadlocks



Application

Door locks for doors with profile frames made from profiles 40×40 and 45×45

Technical data

mortise deadlock: steel, galvanised
 screws and threaded plates: steel, galvanised
 lock insert: GD-Zn, galvanised
 rosette: LM, natural anodised
 case: Al Mg Si 0.5 F25, natural anodised



Door lock without lock insert and handles both sides



Door lock with cylinder lock and handles both sides

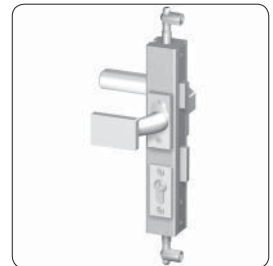

Door lock with lock insert, one handle and one fixed knob

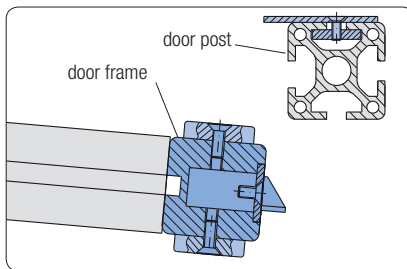

Mounting position left

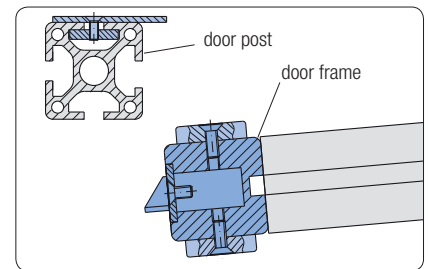

Mounting position right

Profile machining
for door post

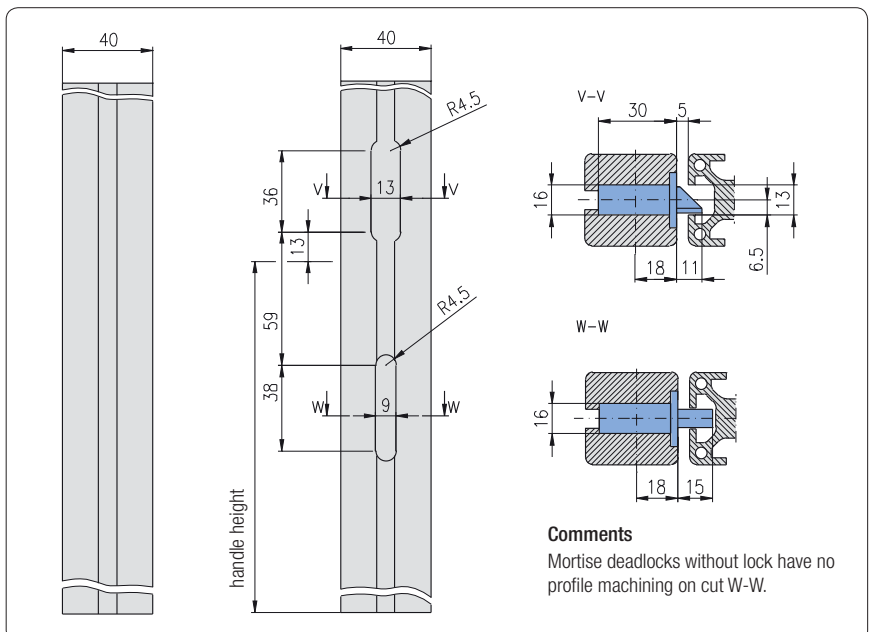

Comments

Mortise deadlocks without lock have no profile machining on cut W-W.

Mortise deadlock installation sets
without lock

Comments
Drawing shows mounting position left,
mirror image mounting position right

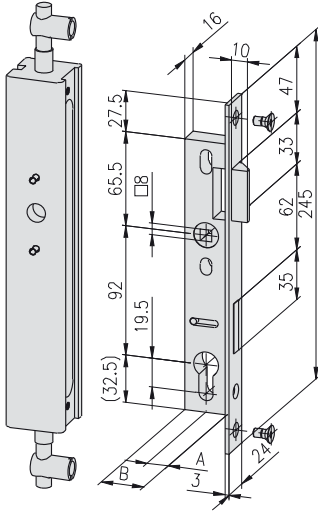

Description	Weight	Article-No.
Mortise deadlock installation set without lock, left, PG 40	1,191 g	1.65.4001L40
Mortise deadlock installation set without lock, right, PG 40	1,191 g	1.65.4001R40
Mortise deadlock installation set without lock, left, PG 45	1,352 g	1.65.4001L45
Mortise deadlock installation set without lock, right, PG 45	1,352 g	1.65.4001R45

Single parts

Description	Pcs.	Weight	Article-No.
Mortise deadlock case without lock PG 40	1	665 g	1.65.4101x40
Mortise deadlock case without lock PG 45	1	790 g	1.65.4101x45
Mortise deadlock left, PG 40	1	412 g	1.65.4211L40
Mortise deadlock right, PG 40	1	412 g	1.65.4211R40
Mortise deadlock left, PG 45	1	430 g	1.65.4211L45
Mortise deadlock right, PG 45	1	430 g	1.65.4211R45
Screw connector PG 40	2	55 g	1.21.4S1M8/11
Screw connector PG 45	2	64 g	1.21.4S1M8/11
Countersunk screw DIN 7991 - M5×12	2	2 g	0.63.D07991.05012

Mortise deadlock cases
without lock

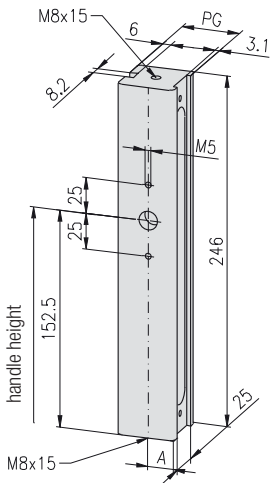

Description	A	B	Weight	Article-No.
Mortise deadlock case without lock				
mounting position le/ri, PG 40	18	30	665 g	1.65.4101x40
mounting position le/ri, PG 45	20	32	790 g	1.65.4101x45

- [16] [20] [30] [40] [45] [50] [60]

Mortise deadlock installation sets
with lock

Comments
Drawing shows mounting position left,
mirror image mounting position right

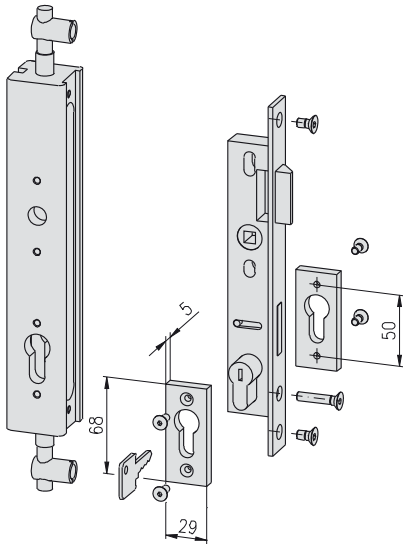

Dimensions → 274, drawing „Mortise
deadlock installation sets
without lock“

Description	Weight	Article-No.
Mortise deadlock installation set with lock, left, PG 40	1,371 g	1.65.4002L40
Mortise deadlock installation set with lock, right, PG 40	1,371 g	1.65.4002R40
Mortise deadlock installation set with lock, left, PG 45	1,535 g	1.65.4002L45
Mortise deadlock installation set with lock, right, PG 45	1,535 g	1.65.4002R45

Single parts

Description	Pcs.	Weight	Article-No.
Mortise deadlock case with lock PG 40	1	620 g	1.65.4102x40
Mortise deadlock case with lock PG 45	1	740 g	1.65.4102x45
Mortise deadlock left, PG 40	1	412 g	1.65.4211L40
Mortise deadlock right, PG 40	1	412 g	1.65.4211R40
Mortise deadlock left, PG 45	1	430 g	1.65.4211L45
Mortise deadlock right, PG 45	1	430 g	1.65.4211R45
Screw connector PG 40	2	55 g	1.21.4S1M8/11
Screw connector PG 45	2	64 g	1.21.4S1M8/11
Lock insert with 2 keys, PG 40	1	188 g	1.65.421240
Lock insert with 2 keys, PG 45	1	196 g	1.65.421245
Countersunk screw DIN 7991 - M5×12	2	2 g	0.63.D07991.05012
Countersunk screw DIN 7991 - M5×30	1	4 g	0.63.D07991.05030
Rosette, set	1	25 g	1.65.4213
Countersunk screw DIN 7991 - M5×12	4	2 g	0.63.D07991.05012

Mortise deadlock cases
with lock

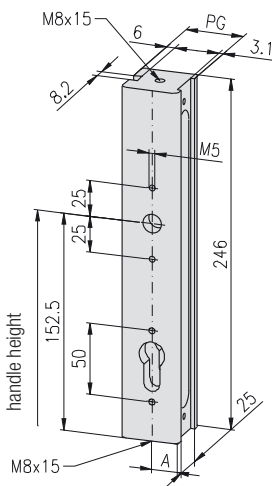

16 20 30 40 45 50 60

Description	A	B	Weight	Article-No.
Mortise deadlock case with lock				
mounting position L/R, PG 40	18	30	620 g	1.65.4102x40
mounting position L/R, PG 45	20	32	740 g	1.65.4102x45

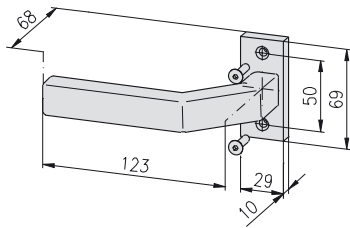
Door handle

Technical data

material: LM
surface: natural anodised

Description	Weight	Article-No.
Door handle set	166 g	1.65.4220

Single parts

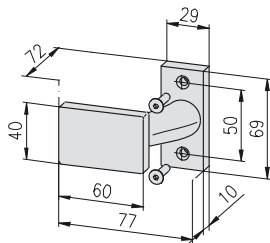
Description	Pcs.	Weight	Article-No.
Handle with rosette	1	160 g	1.65.4221
Countersunk screw DIN 7991 - M5×20	2	3 g	0.63.D07991.05020

Door knob

Technical data

material: LM
surface: natural anodised

Comments

Door knob fixed

Description	Weight	Article-No.
Door knob set	178 g	1.65.4230

Single parts

Description	Pcs.	Weight	Article-No.
Door knob with rosette	1	172 g	1.65.4231
Countersunk screw DIN 7991 - M5×20	2	3 g	0.63.D07991.05020

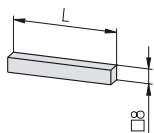
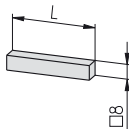
Push pins

Technical data

material: steel
surface: galvanised

Comments

Stop pin for 1 door handle variant only

Description	L	Weight	Article-No.
Push pin for 1 door handle, PG 40	56	28 g	1.65.425140
Push pin for 1 door handle, PG 45	58.5	29 g	1.65.425145

Description	L	Weight	Article-No.
Push pin for 2 door handles, PG 40	94	54 g	1.65.425240
Push pin for 2 door handles, PG 45	99	57 g	1.65.425245

Bar locks



Bar lock with olive



Bar lock with socket wrench

Application

Lock for large doors made of profile 30×60 or 40×80, with pin arrest on top and bottom side

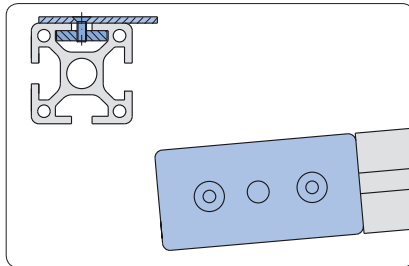

Mounting position right

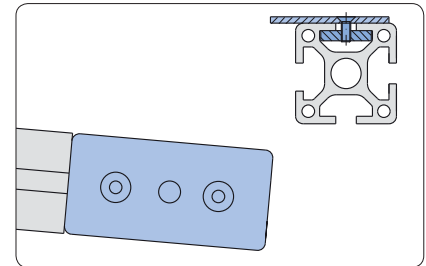

Mounting position left

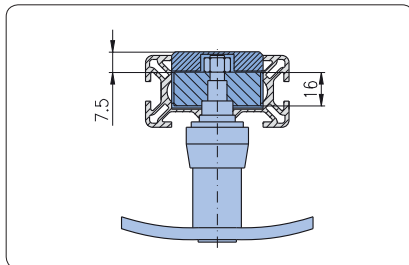

Mounting in profile 30×60

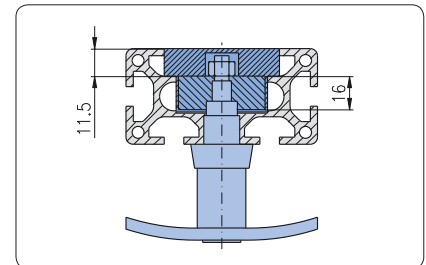

Mounting in profile 40×80

Profile machining 30×60
for bar lock

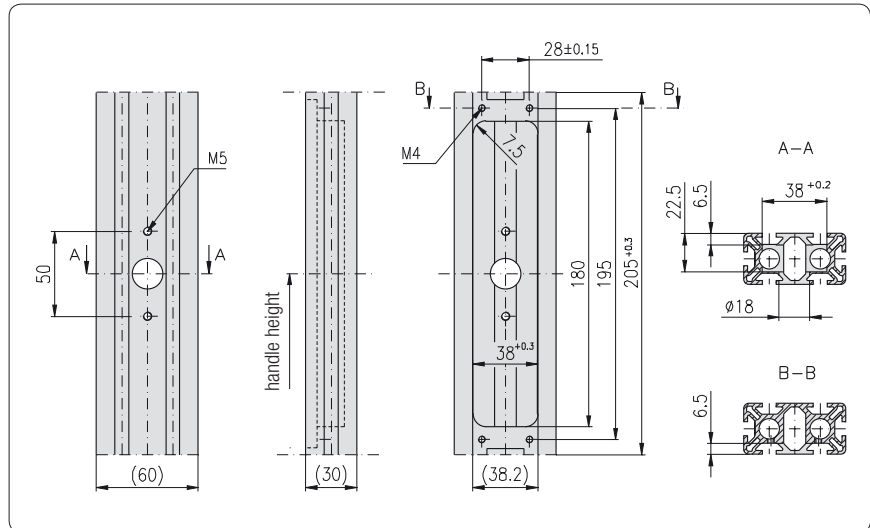
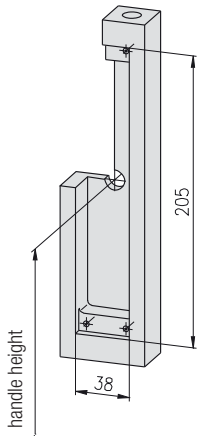

Description

Profile machining 30×60 for bar lock

Article-No.

1.65.5110

Profile machining 40×80
for bar lock

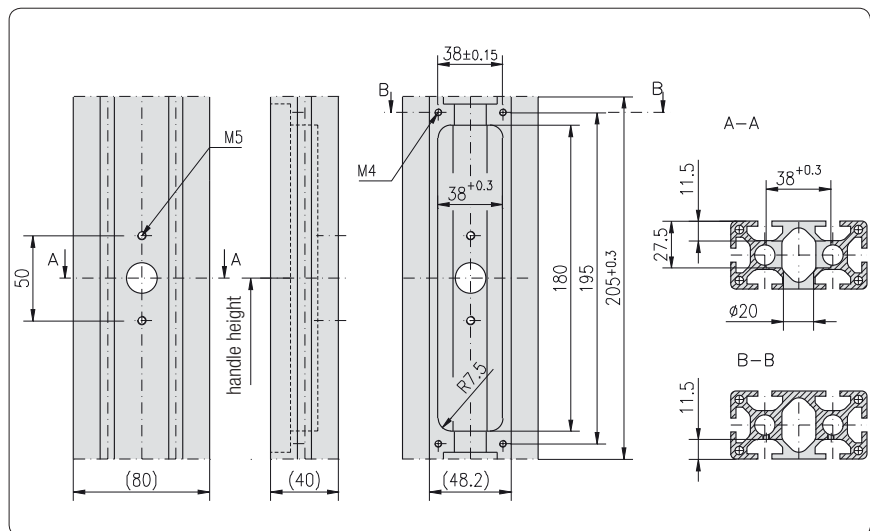
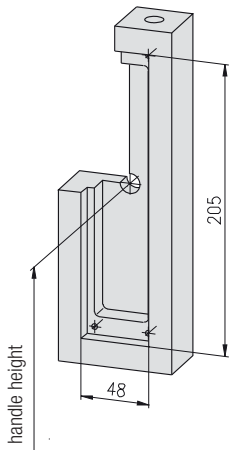

Description

Profile machining 40×80 for bar lock

Article-No.

1.65.5120

Bar locks

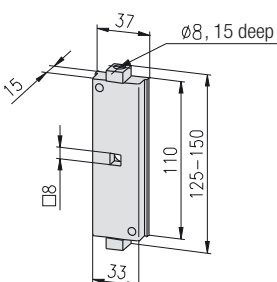

Technical data

material: steel
surface: galvanised

Description

Bar lock, left side
Bar lock, right side

Weight

230 g
230 g

Article-No.

1.65.5210L
1.65.5210R

Bar locks
Technical data

cover plate: alu, natural anodised
 face plate: alu, natural anodised
 bar: steel, galvanised
 screws: steel, galvanised

Assembly accessories 30×60

for bar lock

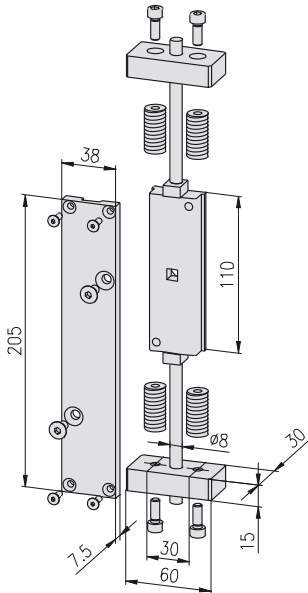

Description	Weight	Article-No.
Assembly accessories 30×60 for bar lock	590 g	1.65.5310

Single parts

Description	Pcs.	Weight	Article-No.
Cover plate 30×60	1	100 g	1.65.5311
Countersunk screw DIN 7991 - M4×12	4	1 g	0.63.D07991.04012
Countersunk screw DIN 7991 - M6×12	2	3 g	0.63.D07991.06012
Front plate 30×60	2	50 g	1.65.5312
Threaded insert M14/M6	4	22 g	1.35.1140615
Cap-screw DIN 912 - M6×16	4	5 g	0.63.D00912.06016
Bar, L1000	2	136 g	1.65.5313

Assembly accessories 40×80

for bar lock

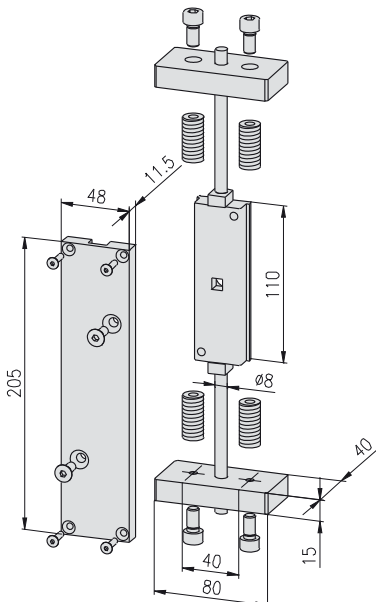

Description	Weight	Article-No.
Assembly accessories 40×80 for bar lock	800 g	1.65.5320

Single parts

Description	Pcs.	Weight	Article-No.
Cover plate 40×80	1	225 g	1.65.5321
Countersunk screw DIN 7991 - M4×16	4	2 g	0.63.D07991.04016
Countersunk screw DIN 7991 - M6×16	2	4 g	0.63.D07991.06016
Front plate 40×80	2	90 g	1.65.5322
Threaded insert M14/M8	4	18 g	1.35.1140815
Cap-screw DIN 912 - M8×16	4	9 g	0.63.D00912.08016
Bar, L1000	2	136 g	1.65.5313

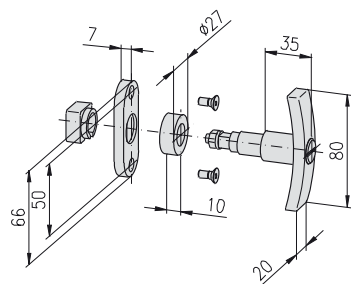
Olive installation set
 for bar lock

Technical data

material: GD-Zn, chrome-plated

Comments

Execution for profile 30×60 = with rosette

Execution for profile 40×80 = without rosette

Description	Weight	Article-No.
Olive installation set for bar lock without lock, for profile 30×60	166 g	1.65.5410
for profile 40×80	160 g	1.65.5420
Olive installation set for bar lock with lock, for profile 30×60	175 g	1.65.5510
for profile 40×80	169 g	1.65.5520

Single parts

Description	Pcs.	Weight	Article-No.
Olive without lock	1	122 g	1.65.5431
Olive with lock, incl. 2 keys	1	120 g	1.65.5531
Rosette	1	8 g	1.65.5432
Countersunk screw DIN 7991 - M5×12	2	2 g	0.63.D07991.05012

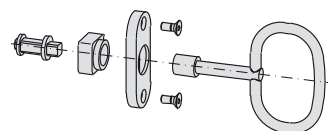
Lock mounting set
with square key
 for bar lock

Technical data

lock insert: GD-Zn, galvanised

key: GD-Zn, galvanised

rosette: LM, natural anodised

key catch: PVC, grey

Description	Weight	Article-No.
Lock mounting set with square key for bar lock	73 g	1.65.5600

Single parts

Description	Pcs.	Weight	Article-No.
Lock insert	1	16 g	1.65.5601
Key catch	1	3 g	1.65.5602
Rosette	1	8 g	1.65.5432
Square key 8 mm	1	42 g	1.65.34581
Countersunk screw DIN 7991 - M5×12	2	2 g	0.63.D07991.05012

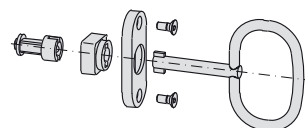
with double beard key
 for bar lock

Description	Weight	Article-No.
Lock mounting set with double beard key for bar lock	73 g	1.65.5700

Single parts

Description	Pcs.	Weight	Article-No.
Lock insert	1	16 g	1.65.5701
Key catch	1	3 g	1.65.5702
Rosette	1	8 g	1.65.5432
Double beard key Ø3	1	42 g	1.65.34789
Countersunk screw DIN 7991 - M5×12	2	2 g	0.63.D07991.05012

Latch locks



Application

Door lock with small jutout

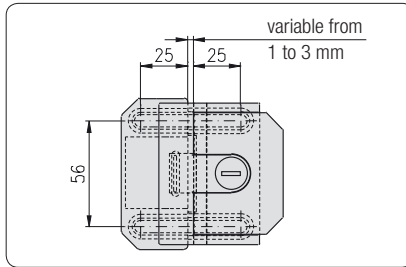

Installation dimensions

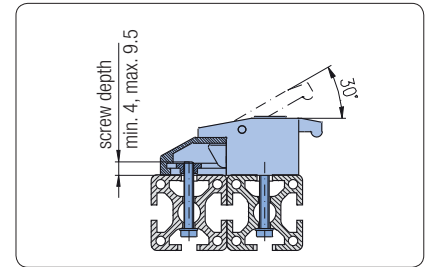

Installation dimensions

Technical data

- material:
- capsule: GDZn black coated
 - trap: GDZn rough
 - nut: steel galvanised

Mounting elements

- cap-screw DIN 6913, M6
- washer DIN 433-6.4

Delivery unit

- latch lock
- 4 nuts M6
- 2 keys (by variant with lock)
- cover plug (by variant without lock)

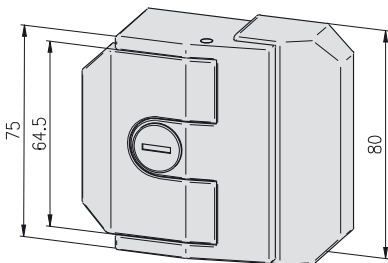

Description

Description	Weight	Article-No.
Latch lock without lock	560 g	1.65.6010
Latch lock with lock, all keyed alike	560 g	1.65.6020
Latch lock with lock, keyed different	560 g	1.65.6030

Roller 39

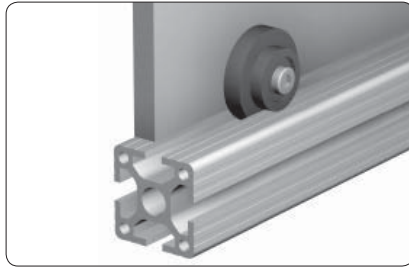

Application

Roller for guiding in the 8 mm profile slot for sliding doors

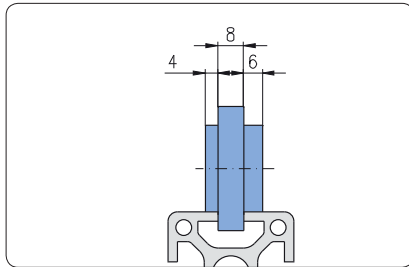

Asymmetric mount

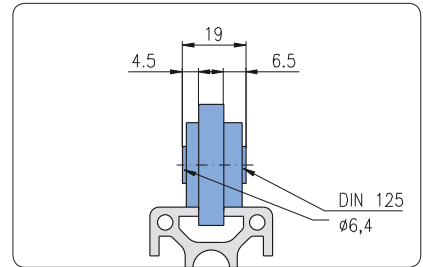

Mounting measure incl. washer DIN 125

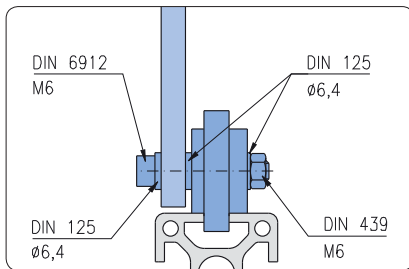

Mounting with threaded pillar

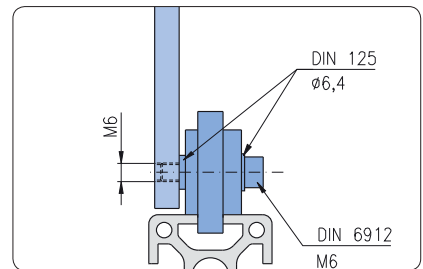

Mounting with thread in panel element

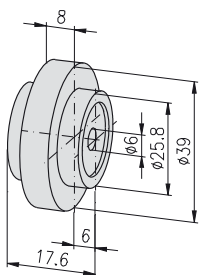
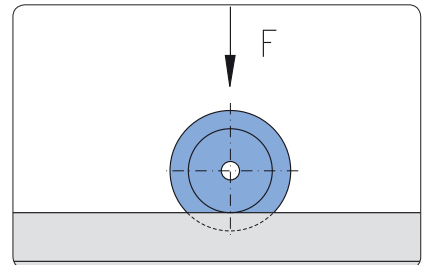

Technical data

material: PA-GF
 colour: black
 max. static load: F = 150 N

Comments

2 deep grooved ball bearings with 2 cover discs

Description

Roller 39

Weight

32 g

Article-No.

1.66.1395

Roller 29

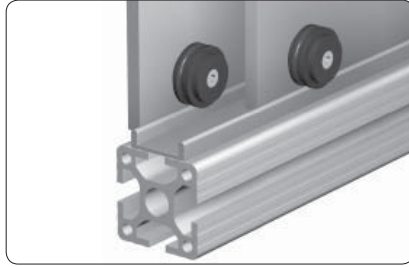

Application

Roller for guiding in the 8 mm profile slot or in the twin track

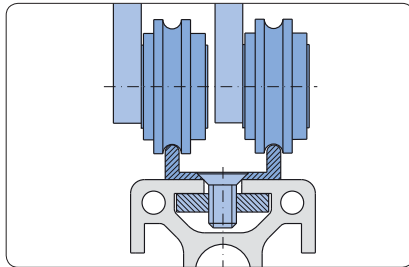

Guiding in the twin track

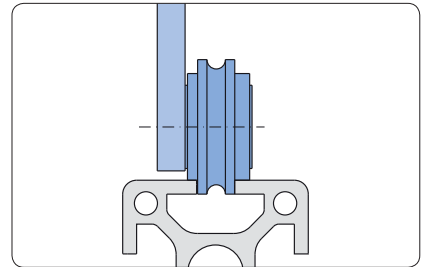

Guiding in the profile slot

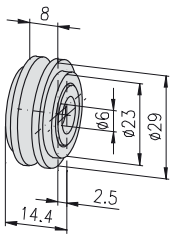
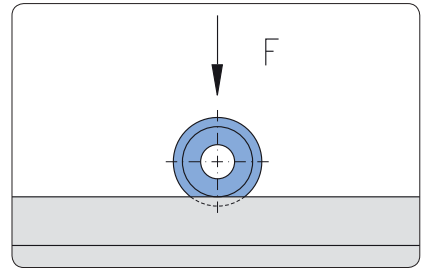
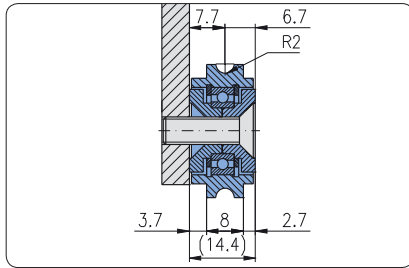

Technical data

material: PA-GF
 colour: black
 max. static load: $F = 150$ N

Comments

1 deep grooved ball bearing with 2 sealing discs

Description

Roller 29

Weight

12 g

Article-No.

1.66.2290

Twin track guide

Technical data

material: plastic
 colour: white

Comments

Fastening of the twin track guide with
 • threaded plate
 • countersunk screw

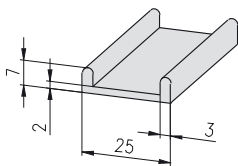

Description

Twin track guide, L2500

Weight

255 g

Article-No.

1.66.3100

Roller fastening sets
type A

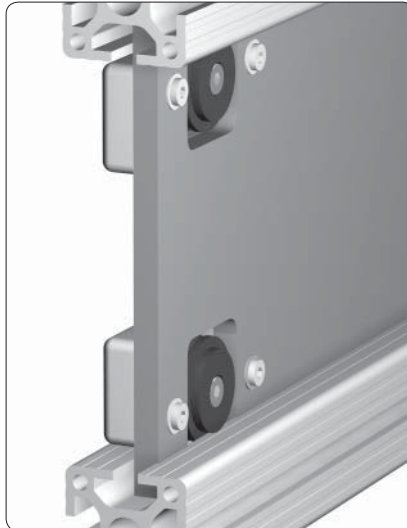

Roller fastening set type A, one-sided

Application

The roller fastening set allows the mounting of the roller into the panel element. Thus the panel element fits in the slot and fills the frame completely

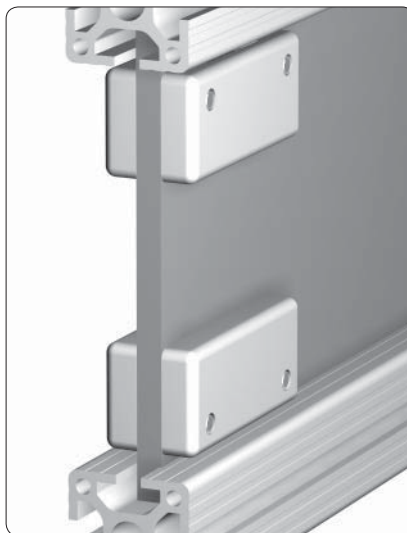

Roller fastening set type A, double-sided

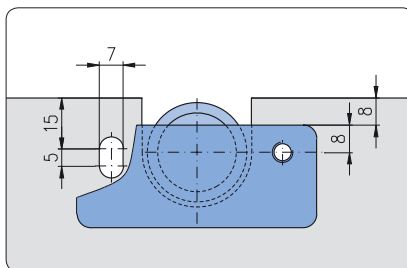

Mounting on top side

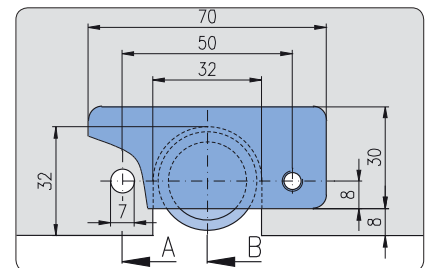

Mounting on bottom side

Comments

The elongated hole in the panel element allows the adjustment of the height tolerance

Roller fastening sets
type A

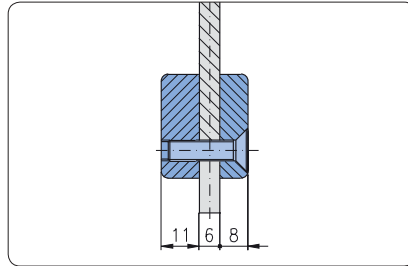

Panel element 6 mm
View A - A

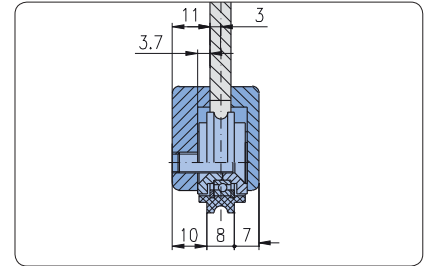

Panel element 6 mm
View B - B

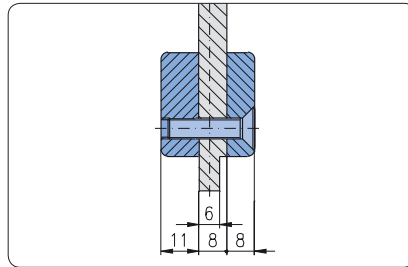

Panel element 8 mm
View A - A

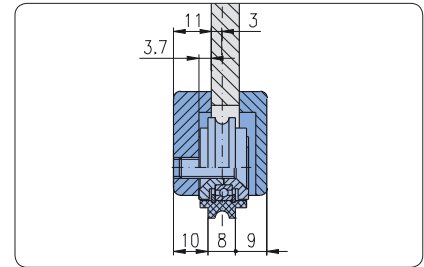

Panel element 8 mm
View B - B

Technical data

base body
material: aluminium
surface: natural anodised

one sided

Description	Weight	Article-No.
Roller fastening set type A, one sided, complete	55.5 g	1.66.5160

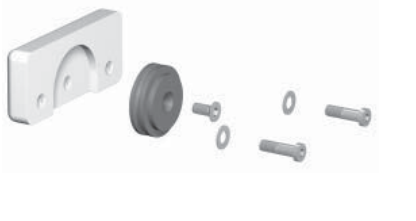

Single parts

Description	Pcs.	Weight	Article-No.
Roller bracket type A, left	1	21.0 g	1.66.5299
Roller 29	1	12.0 g	1.66.2290
Countersunk screw DIN 7991 - M6×20	1	4.5 g	0.63.D07991.06020
Cap-screw DIN 6912 - M6×20	2	5.0 g	0.63.D06912.06020
Washer DIN 6340 - 6.4	2	4.0 g	0.62.D06340.06,4

double sided

Description	Weight	Article-No.
Roller fastening set type A, double sided, complete	64.5 g	1.66.5260



Single parts

Description	Pcs.	Weight	Article-No.
Roller bracket type A, right	1	16.0 g	1.66.5298
Roller bracket type A, left	1	21.0 g	1.66.5299
Roller 29	1	12.0 g	1.66.2290
Countersunk screw DIN 7991 - M6×20	1	4.5 g	0.63.D07991.06020
Countersunk screw DIN 7991 - M6×25	2	5.5 g	0.63.D07991.06025

Roller fastening sets
type B

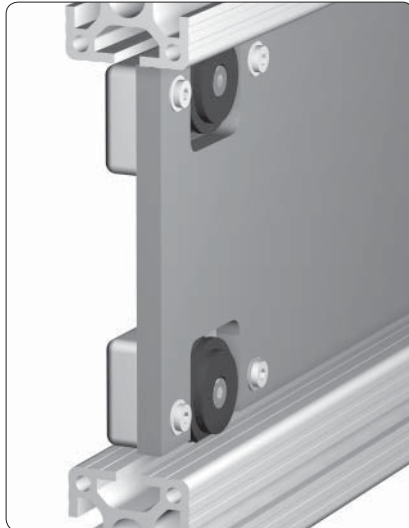

Guidance in profile slot

Application

The roller fastening set allows the mounting of the roller into the panel element

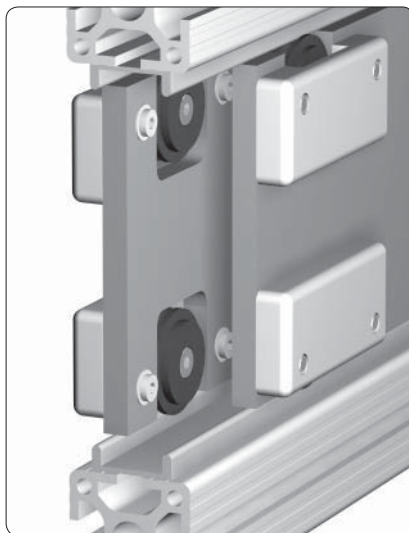
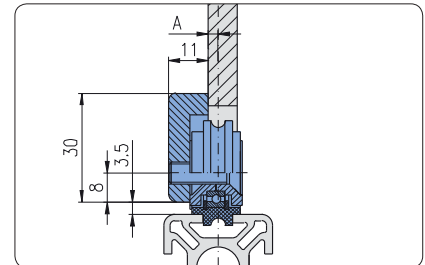

Guidance in twin track guide

Comments

Mounting position of roller optional

A = 1.7 mm

2.7 mm

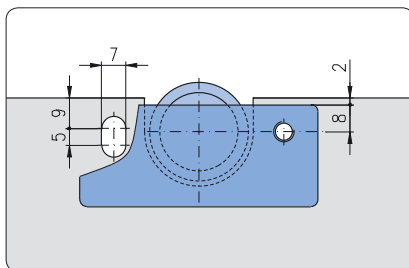

Mounting on top side

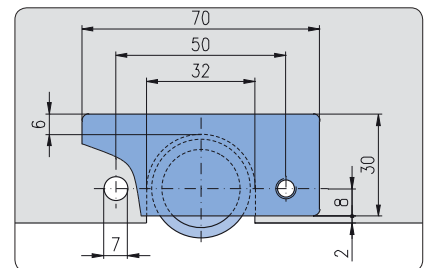

Mounting on bottom side

Comments

The elongated hole in the panel element allows to adjust the height tolerance and to unhinge the sliding door

**Roller fastening sets
type B**

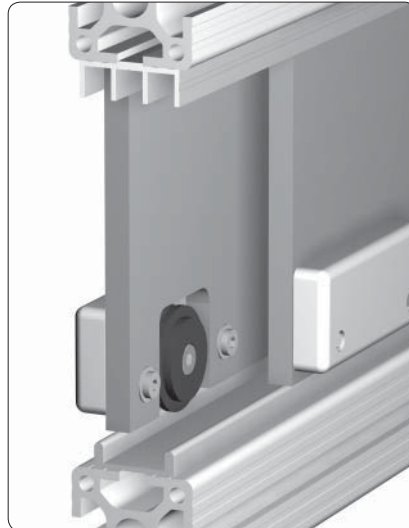

Application

Guidance of sliding door
 on top: sliding profile 30x14
 on bottom: twin track guide with profile

The slot in the panel element allows:

- adjustment of height tolerance
- removal of the sliding door

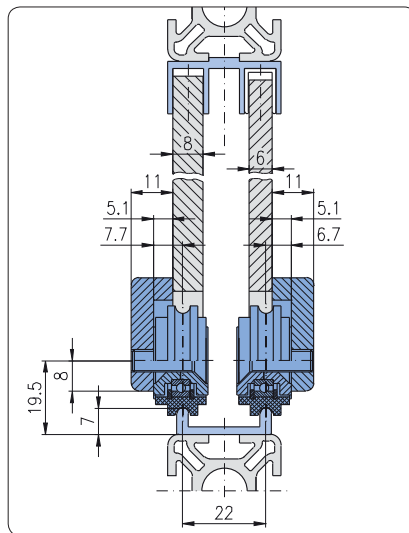

Mounting position of roller:
 dimension 6.7 = panel element 6 mm
 dimension 7.7 = panel element 8 mm

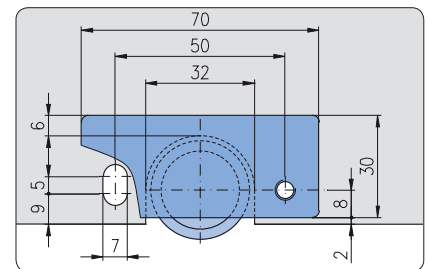

Technical data

base body
 material: aluminium
 surface: natural anodised

Description	Weight	Article-No.
Roller fastening set type B, complete	62 g	1.66.5360

Single parts



Description	Pcs.	Weight	Article-No.
Roller bracket type B	1	21.0 g	1.66.5399
Roller 29	1	12.0 g	1.66.2290
Countersunk screw DIN 7991 - M6x20	1	4.5 g	0.63.D07991.06020
Cap-screw DIN 6912 - M6x20	2	5.0 g	0.63.D06912.06020
Washer DIN 6340 - 6.4	2	4.0 g	0.62.D06340.06,4

Mounting adaptor for roller

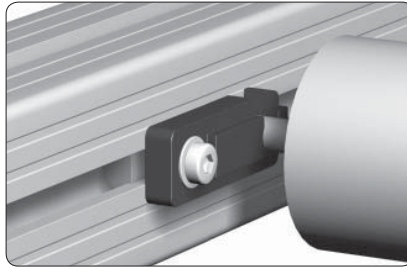

Application
For fastening of rollers

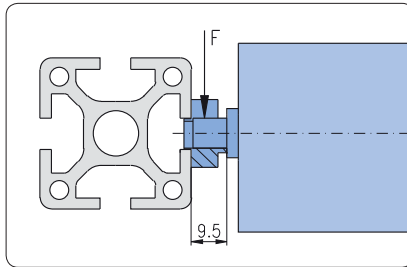

Comments
Simple mounting, enables installation without
dismounting of frame
 $F_{max} = 1,000 \text{ N}$

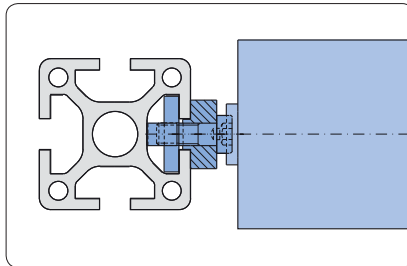

Technical data

material: PA, black

Mounting elements

- F-slot: threaded plate F M6 1.31.FM6
- E-slot: threaded plate E M6 1.31.EM6
- threaded plate, heavy E M6 1.31.6EM6
- cap-screw DIN 6912, M6

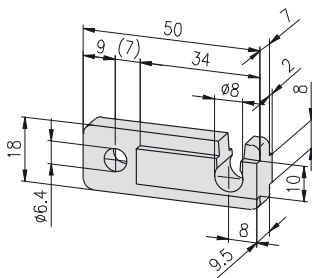

Description	Weight	Article-No.
Mounting adaptor for roller Ø8	9 g	1.66.70808

Edge roller

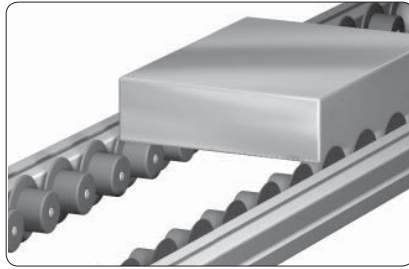

Application

Roller conveyors for transporting boxes and containers

- low noise
- low friction operation due to double ball bearings
- simple assembly

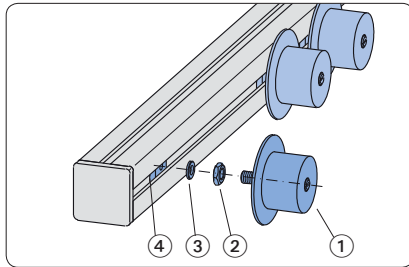

Single parts

- ① edge roller
- ② hexagon nut
- ③ shim
- ④ threaded plate

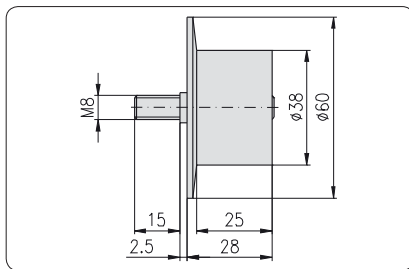

Technical data

material:

- roller: impact resistant plastic
- axle: galvanised

colour:

- roller: black

bearings: steel or stainlessball bearings
on galvanised steel bolt

loading capacity:

- static: 50 N
- dynamic: 100 N

Mounting elements

threaded plate E M8	1.31.EM8
hexagon nut DIN 934 - M8	0.61.D00934.08
washer DIN 125 - 8.4	0.62.D00125.A08,4

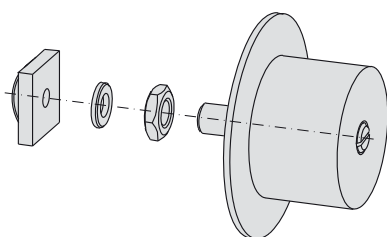

Description

Edge roller E

Weight

51.0 g

Article-No.

1.66.7523860

Runner
for sliding suspended doors



Application

Sliding suspended doors made of profile frames for large openings and heavy doors

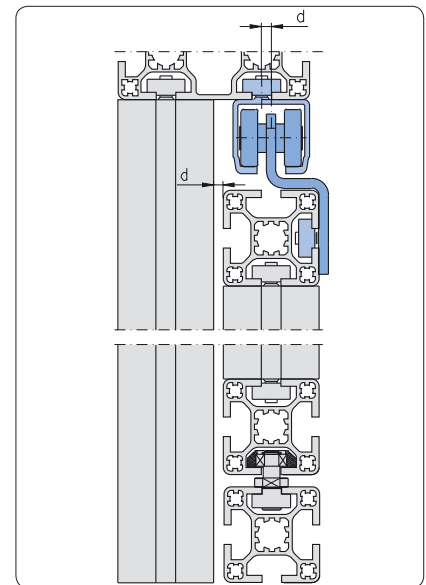
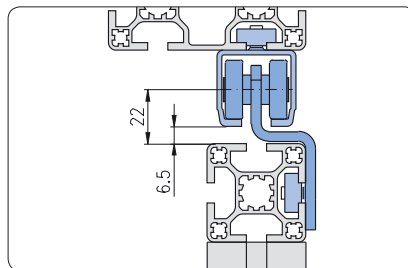
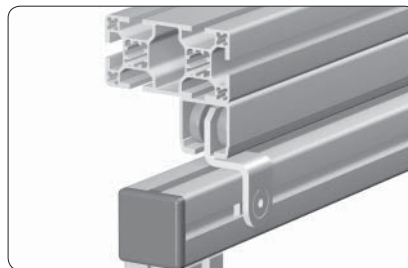

Distance d = mismatch of Alu C-track

Alu C-track
for suspended doors

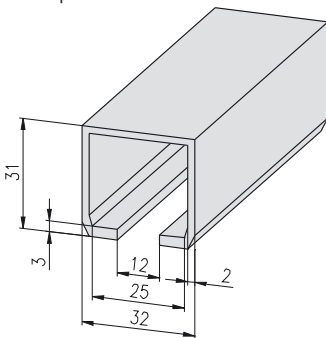

Technical data

bar length: 6 m
material: aluminium
surface: natural anodised

Description

Description	Weight	Article-No.
Alu C-track bar	3.6 kg	1.19.14532.60
Alu C-track cut to length	0.6 kg	1.19.14532-A00A00/...

/... = length in mm

Runner
for sliding suspended door

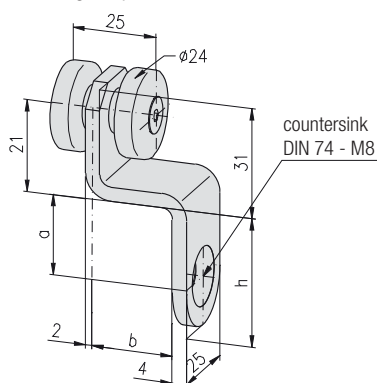

Technical data

material: VA
• strap: VA
• bolt: C45 K
• distance bush: AlMg3
max. load capacity: 100 kg

Comments

Countersink DIN 74 - M8 for countersunk screw DIN 7991 - M8

Description

Description	a	b	h	Weight	Article-No.
Runner for sliding susp. door, PG 40	21.0	20.0	38.0	102 g	1.66.81140
Runner for sliding susp. door, PG 45	23.5	22.5	43.0	114 g	1.66.81145

Stopper Type 1
for sliding suspended door

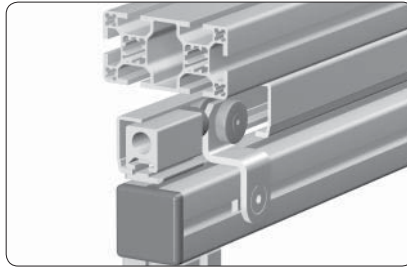
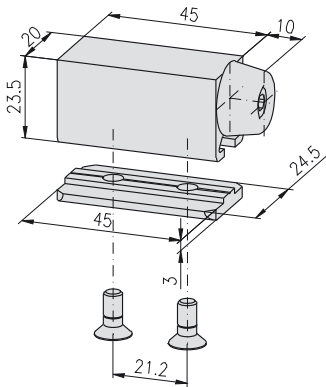

Description	Weight	Article-No.
Stopper Type 1 for sliding suspended door, complete	63 g	1.66.8201055

Stopper Type 2
for sliding suspended door

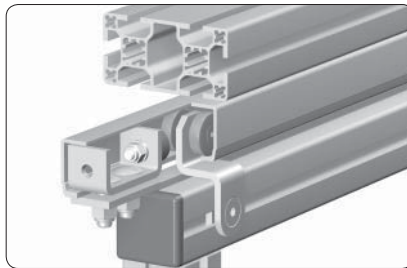
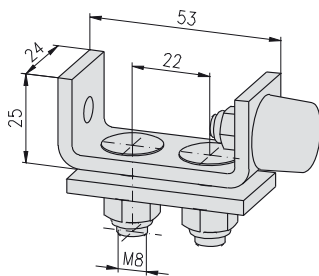

Description	Weight	Article-No.
Stopper Type 2 for sliding suspended door, complete	160 g	1.66.8202065

Frame guide
for suspended door

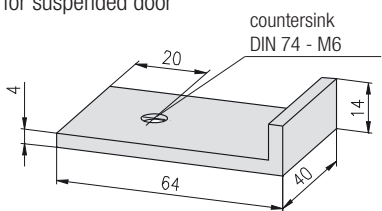

Technical data

material: aluminium
surface: natural anodised

Comments

Countersink DIN 74 - M6 for countersunk screw DIN 7991 - M6

Description	Weight	Article-No.
Frame guide for suspended door	30 g	1.66.8050

Rubber door stop
for suspended door

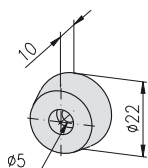

Technical data

material: rubber
colour: black

Description	Weight	Article-No.
Rubber door stop for suspended door	3 g	1.66.8060

Slot rollers

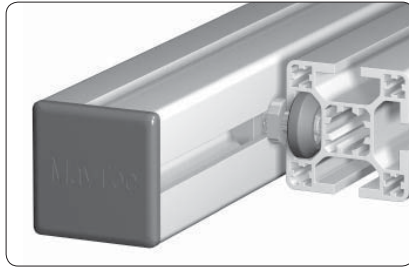

Application

For light running sliding doors

Technical data

material: PETP
 colour: black
 max. static load: 8 kg/roller

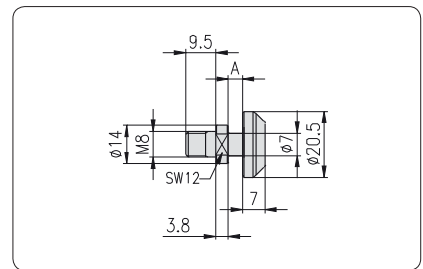
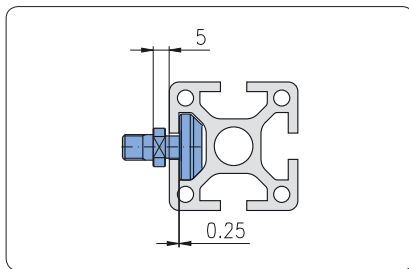
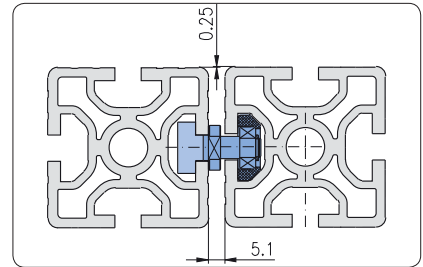
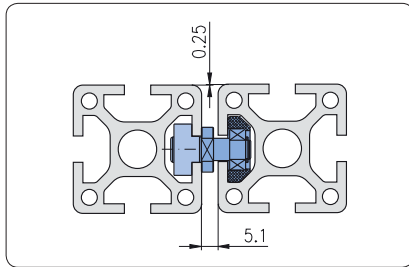

Fastening elements (optional)

- threaded plate E M8 1.31.EM8
- threaded plate, heavy, E M8 1.31.6EM8
- T-Nut, E M8 1.32.EM8
- T-Nut for subs. insertion E, M8 1.32.4EM8

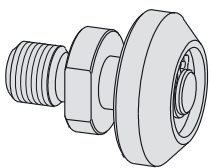

Description	A	Weight	Article-No.
Slot roller E3	4.45	24 g	1.67.42E3M8

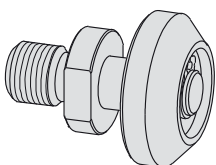

Description	A	Weight	Article-No.
Slot roller E4	5.45	24 g	1.67.42E4M8

Guidance system



Application

Slideway with sliding blocks e.g. for lifting tables and drawers

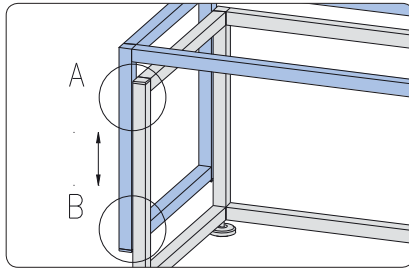

Slideway for lifting table

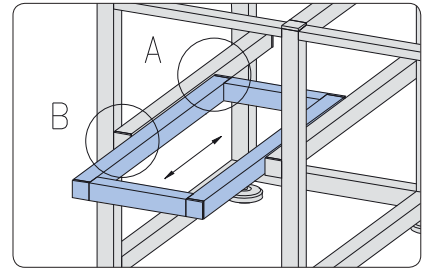

Slideway for drawer

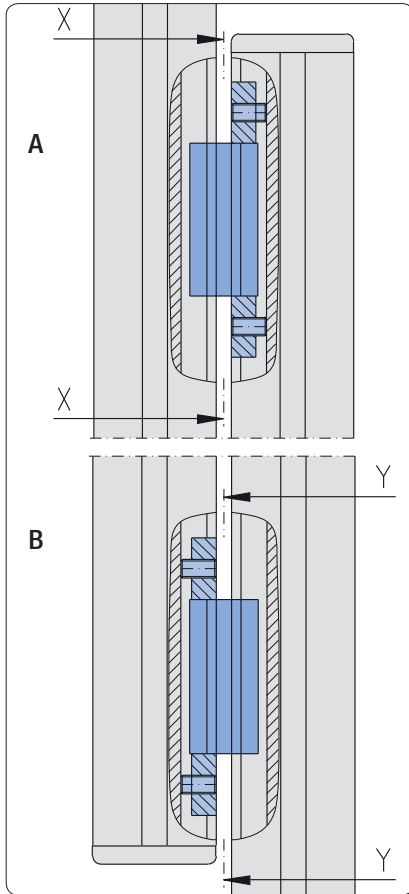

Details "A" and "B"

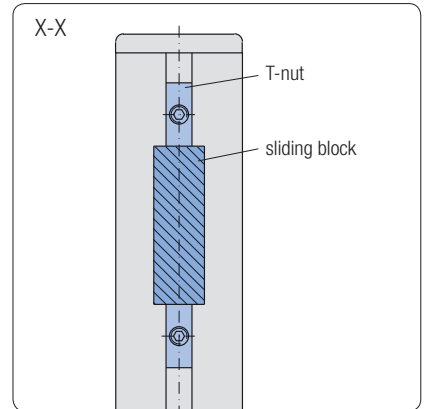

View "X"

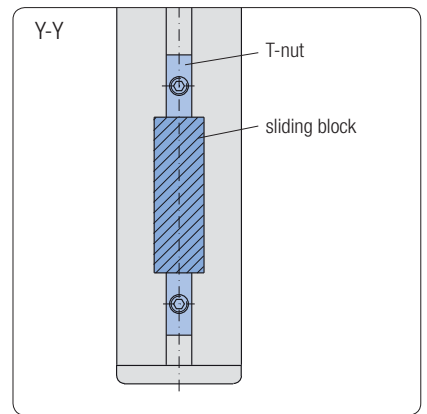

View "Y"

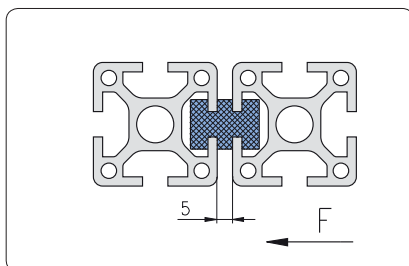

Clamping

for guidance system

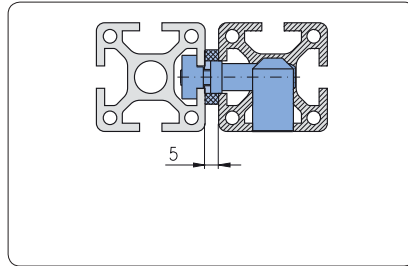

Clamping with setscrew

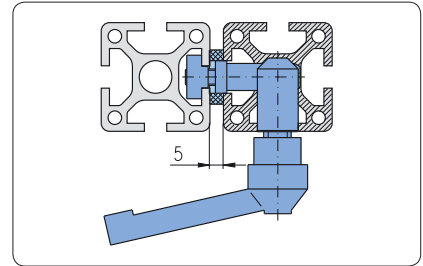

Clamping with clamping lever

Single parts for clamping

Description	Article-No.
T-nut sliding block	1.67.□M8
Distance washer	1.67.2008
Clamping lever	1.29.801030

Connector

Description	for profile	Article-No.
Connector, screw-type, parallel, M8	30×30	1.21.3/4S5M8/7
Connector, screw-type, parallel, M8	40×40	1.21.4/5S5M8/11
Connector, screw-type, parallel, M8	45×45	1.21.45/5S5M8/11
Connector, screw-type, parallel, M8	50×50	1.21.5/6S5M8/11
Connector, screw-type, parallel, M8	60×60	1.21.6S1M8/11

Sliding blocks

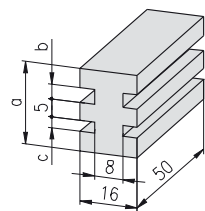
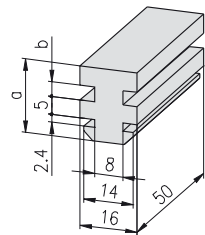
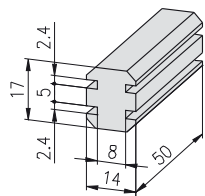

Technical data

material: PA6G oil, (murlubric or similar)
 colour: black
 max. carrying capacity: $p = 20 \text{ N/mm}^2$
 at

- temperature 20°C
- velocity 1 m/sec

Comments

raw finish on request

Description	F	Weight	Article-No.
Sliding block F	1,500 N	11 g	1.67.F2F2

Description	a	b	F	Weight	Article-No.
Sliding block F/E3	19.6	3.2	1,500 N	15 g	1.67.F2E3
Sliding block F/E4	20.6	4.2	1,500 N	15 g	1.67.F2E4

Description	a	b	c	F	Weight	Article-No.
Sliding block E3	22.2	3.2	3.2	2,000 N	18 g	1.67.E3E3
Sliding block E3/E4	23.2	3.2	4.2	2,000 N	18 g	1.67.E3E4
Sliding block E4	24.2	4.2	4.2	2,000 N	23 g	1.67.E4E4

T-nut sliding blocks

Technical data

material: PA6G oil (murlubric or similar)
 colour: black

Comments

raw finish on request

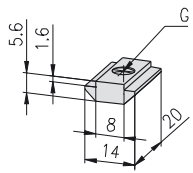

Description	G	Weight	Article-No.
T-nut sliding block F	M6	1.5 g	1.67.FM6
T-nut sliding block F	M8	1.5 g	1.67.FM8

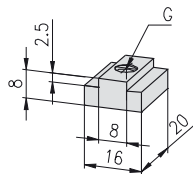

Description	G	Weight	Article-No.
T-nut sliding block E	M6	3.0 g	1.67.EM6
T-nut sliding block E	M8	3.0 g	1.67.EM8

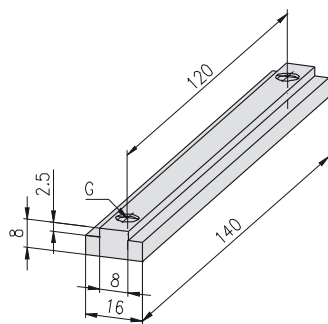

Description	G	Weight	Article-No.
T-nut sliding block E	2×M6	17.0 g	1.67.E2M61400
T-nut sliding block E	2×M8	16.6 g	1.67.E2M81400

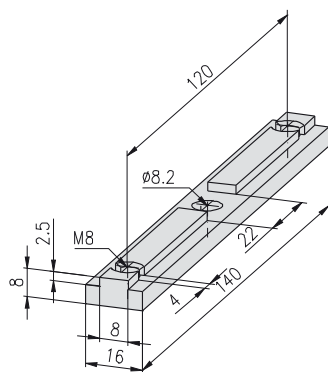

Description	Weight	Article-No.
T-nut sliding block E 2×M8 for Eco-Slide with clamping lever	15.6 g	1.67.E2M81408

Distance washer

Technical data

material: PVC
 colour: grey

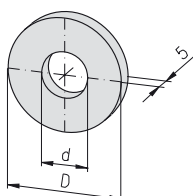

Description	D	d	Weight	Article-No.
Distance washer	22	8.3	3.0 g	1.67.2002
Distance washer	28	13.0	3.0 g	1.67.2008

Eco-Slides

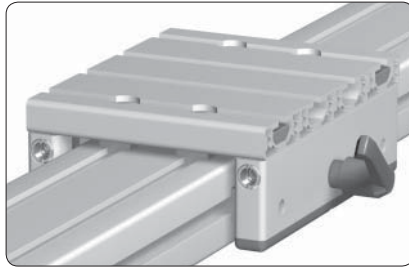

Application

Sliding carriage in variable, simple and rugged design with low sliding resistance

High tolerance adjustment for width and height

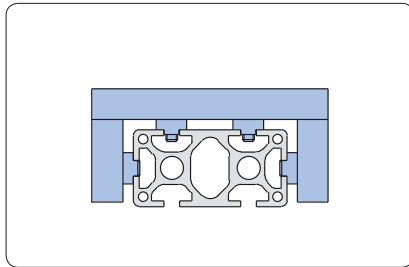

without clamping lever

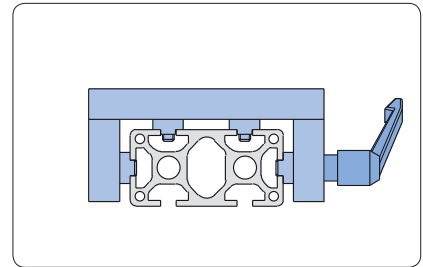

with clamping lever

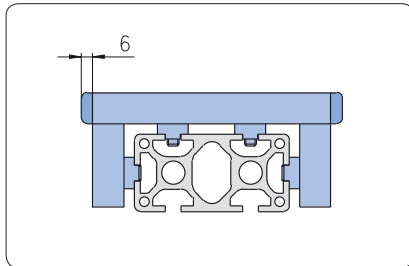

with side cover caps

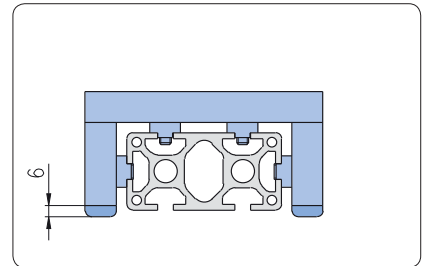

with lower cover caps

Eco-Slide
for profile group 30
F-slot

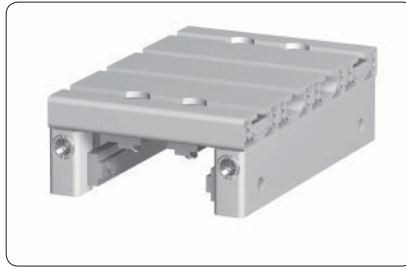

Technical data

loading capacity: max. 1,000 N

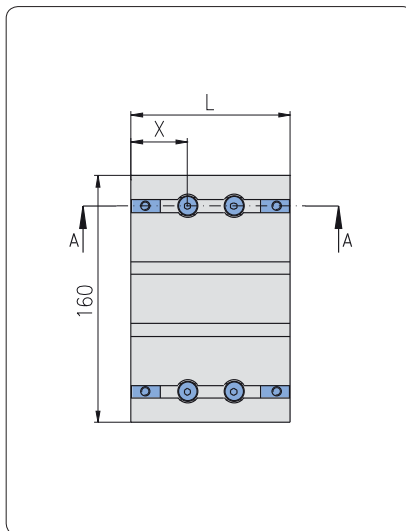
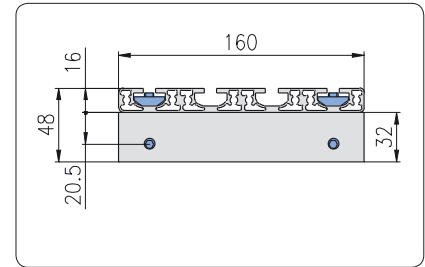
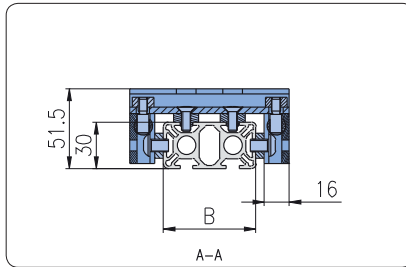

Width of profile

30 mm

Description	B	X	L	Weight	Article-No.
Eco-Slide, PG 30 - 30F		36,5	73	510 g	1.67.S101.030030F
Eco-Slide, PG 30 - 30F, with clamping lever		36,5	73	549 g	1.67.S102.030030F

60 mm

Description	B	X	L	Weight	Article-No.
Eco-Slide, PG 30 - 60F		36,5	103	600 g	1.67.S101.030060F
Eco-Slide, PG 30 - 60F, with clamping lever		36,5	103	639 g	1.67.S102.030060F

100 mm

Description	B	X	L	Weight	Article-No.
Eco-Slide, PG 30 - 100F		46,5	143	720 g	1.67.S101.030100F
Eco-Slide, PG 30 - 100F, with clamping lever		46,5	143	759 g	1.67.S102.030100F

150 mm

Description	B	X	L	Weight	Article-No.
Eco-Slide, PG 30 - 150F		46,5	193	810 g	1.67.S101.030150F
Eco-Slide, PG 30 - 150F, with clamping lever		46,5	193	849 g	1.67.S102.030150F

Eco-Slide

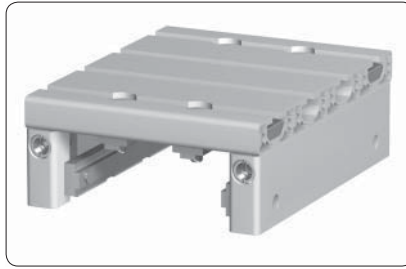
 for profile group 40
 E-slot

Technical data

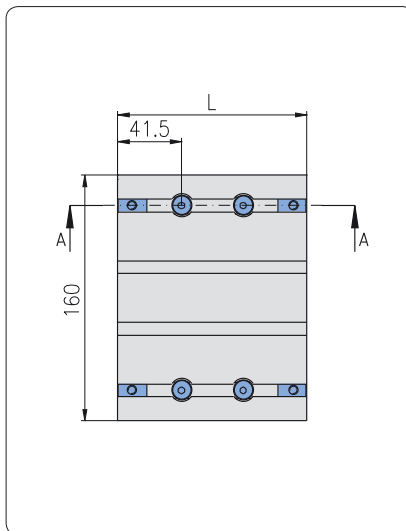
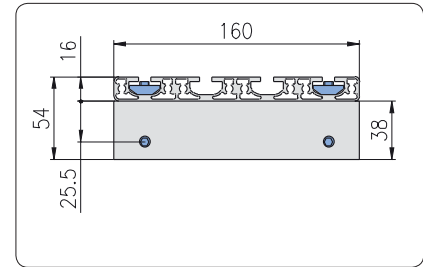
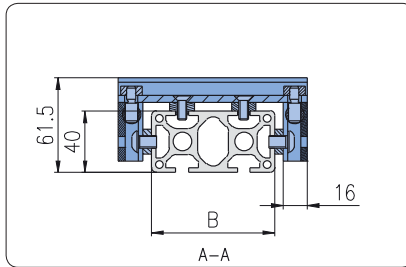
loading capacity: max. 1,000 N

Width of profile
40 mm

Description	B	L	Weight	Article-No.
Eco-Slide, PG 40 - 40E		83	555 g	1.67.S101.040040E
Eco-Slide, PG 40 - 40E, with clamping lever		83	594 g	1.67.S102.040040E

80 mm

Description	B	L	Weight	Article-No.
Eco-Slide, PG 40 - 80E		123	670 g	1.67.S101.040080E
Eco-Slide, PG 40 - 80E, with clamping lever		123	709 g	1.67.S102.040080E

120 mm

Description	B	L	Weight	Article-No.
Eco-Slide, PG 40 - 120E		163	790 g	1.67.S101.040120E
Eco-Slide, PG 40 - 120E, with clamping lever		163	829 g	1.67.S102.040120E

160 mm

Description	B	L	Weight	Article-No.
Eco-Slide, PG 40 - 160E		203	910 g	1.67.S101.040160E
Eco-Slide, PG 40 - 160E, with clamping lever		203	949 g	1.67.S102.040160E

Eco-Slide
for profile group 45
E-slot

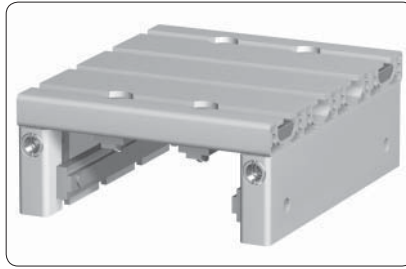

Technical data

loading capacity: max. 1,000 N

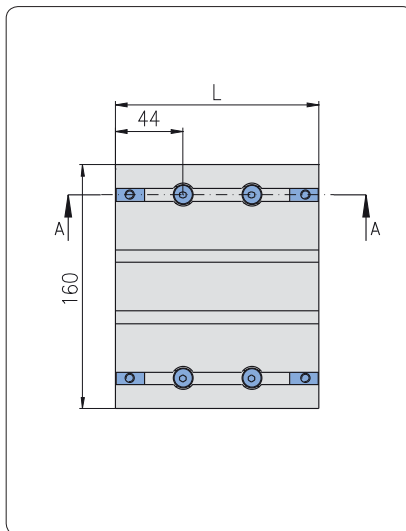
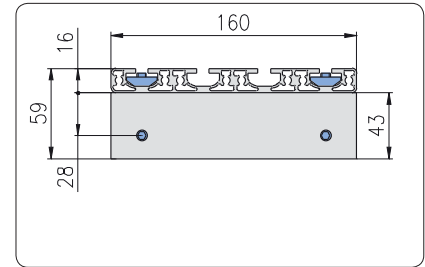
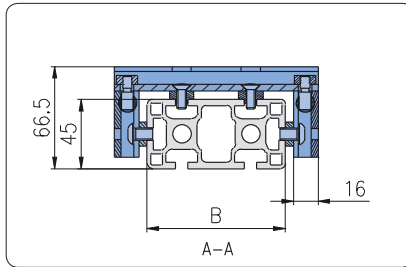

Width of profile

45 mm

Description	B	L	Weight	Article-No.
Eco-Slide, PG 45 - 45E		88	665 g	1.67.S101.045045E
Eco-Slide, PG 45 - 45E, with clamping lever		88	704 g	1.67.S102.045045E

90 mm

Description	B	L	Weight	Article-No.
Eco-Slide, PG 45 - 90E		133	710 g	1.67.S101.045090E
Eco-Slide, PG 45 - 90E, with clamping lever		133	749 g	1.67.S102.045090E

Hanging bracket

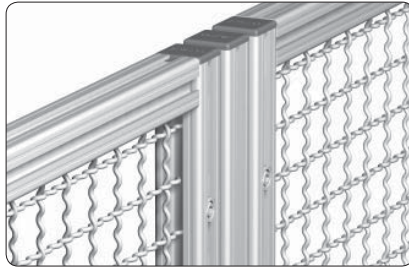

Application

Element for mounting un hingeable fence elements

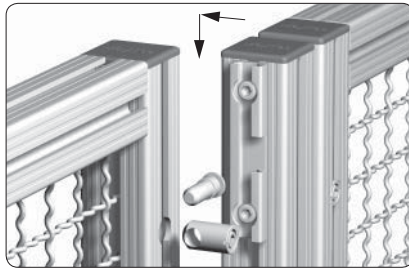

The connector cross bushing can be fixed at the front or back

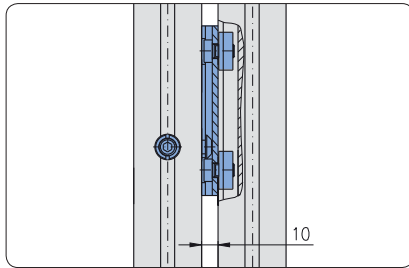

Technical data

material: aluminium
 strength: F25
 surface: natural anodised

Comments

- Elements needed for mounting:
- cap-screw DIN 6912 M8×12 with threaded plate
 - T-Nut for subsequent insertion M8 with cap-screw DIN 6912 M8×10
 - parallel-connector with F-head

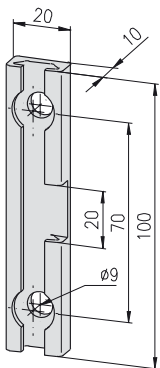

Description

Hanging bracket

Weight

16 g

Article-No.

1.68.201050

Suspended glider

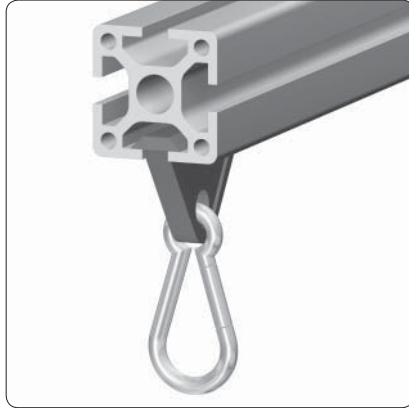

Application

Element for tool suspension in MayTec-profile

Technical data

material: PA-GF
 colour: black
 max. static load: 300 N

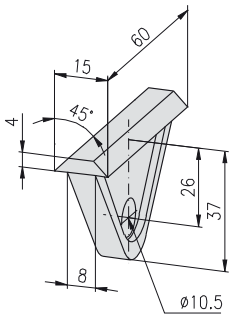

Description

Suspended glider F

Weight

10 g

Article-No.

1.69.F010

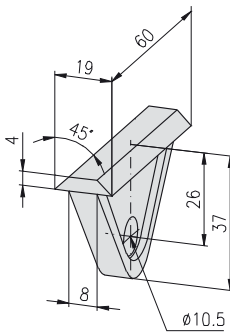

Description

Suspended glider E

Weight

10 g

Article-No.

1.69.E010

Carabine swivel

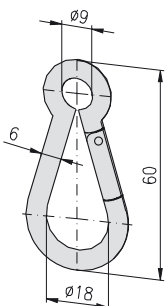

Technical data

material: steel
 surface: galvanised

Description

Carabine swivel 60x6

Weight

27 g

Article-No.

1.69.1606

Potential equalisation



Application

Ground connections to establish the potential equalisation between two profiles
The serration at the bottom of the socket head of the connector pushes through the anodised coating of the profiles and thus provides the electrical contact

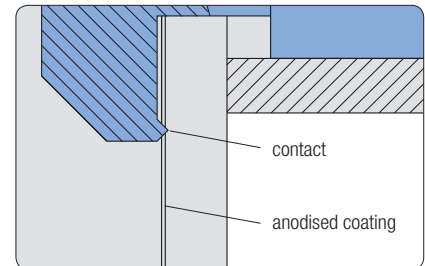
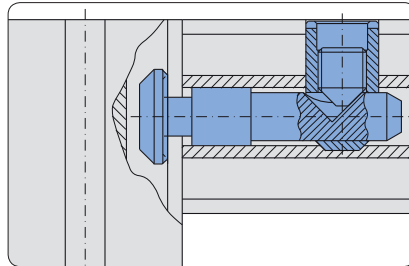

Comments

Suitable to equalise charge accumulations
Not suitable for higher currents

Technical data

Low current measurements in accordance with DIN VDE 0413, Part 4 for the control of protective circuits, earthing circuits and potential equalisation methods through low resistance connections for protection against dangerous currents

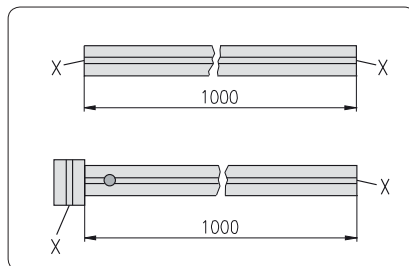

Resistance values with DC current of more than 200 mA with 1.0 m alu-profile	
without connector	0.11 Ω
with 1 standard connector	> 2 MΩ
with 1 univ. grounding connector	0.11 Ω

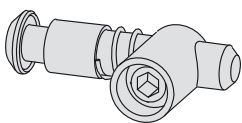

Description

Description	Article-No.
Connector, universal, grounding, PG 20	1.21.2FOE
Connector, universal, grounding, PG 30	1.21.3FOE
Connector, universal, grounding, PG 40	1.21.4FOE
Connector, universal, grounding, PG 45	1.21.45FOE
Connector, universal, grounding, PG 50	1.21.5FOE
Connector, universal, grounding, PG 60	1.21.6FOE

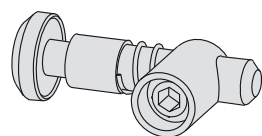

Description

Description	Article-No.
Connector, universal, grounding, PG 20	1.21.2EOE
Connector, universal, grounding, PG 30	1.21.3EOE
Connector, universal, grounding, PG 40	1.21.4EOE
Connector, universal, grounding, PG 45	1.21.45EOE
Connector, universal, grounding, PG 50	1.21.5EOE
Connector, universal, grounding, PG 60	1.21.6EOE

Comments

More grounding connectors
↪ Connectors 1.2A

Ground connections

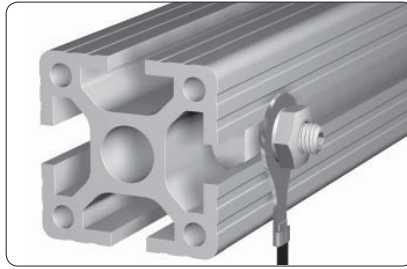

Application

Couplings for grounding of anodised profiles

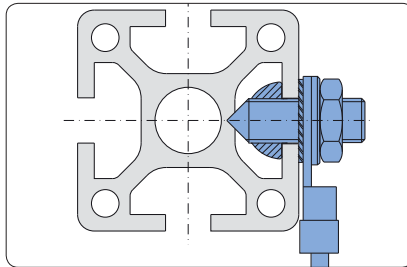

Comments

The grounding is caused by breaking the anodised layer at the bottom of the slot and at the profile's front side

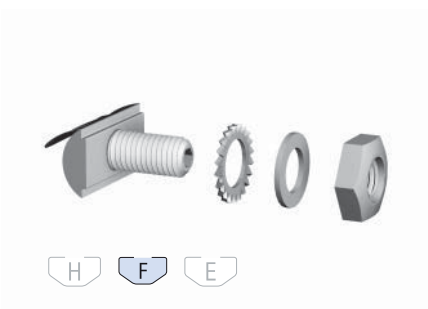

Description

Ground connection F, M6

Weight

74 g

Article-No.

1.70.10FM6

Single parts

T-Nut for subsequent insertion F, M6

Setscrew DIN 914 - M6×25 - V2A

Fan type lock washer DIN 6798 - A6.4 - V2A

Hexagon nut DIN 439 - M6 - Ms

Washer with chamfer DIN 125 - B6.4 - Ms

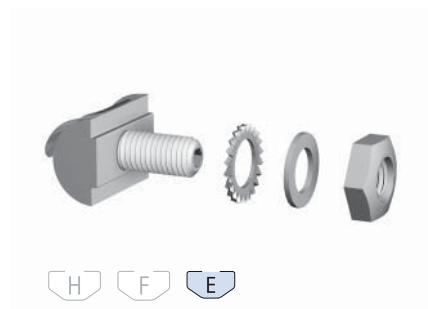

Description

Ground connection E, M8

Weight

146 g

Article-No.

1.70.10EM8

Single parts

T-Nut for subsequent insertion E, M8

Setscrew DIN 914 - M8×25 - V2A

Fan type lock washer DIN 6798 - A8.4 - V2A

Hexagon nut DIN 439 - M8 - Ms

Washer with chamfer DIN 125 - B8.4 - Ms

Cable and hose clamp

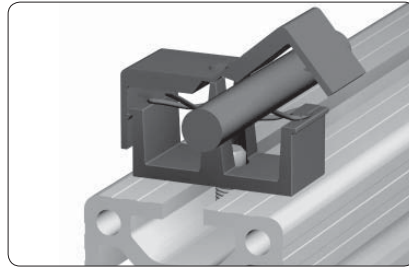

Application

Fixing element for cables and hoses up to $\varnothing 12$ mm

Technical data

material: PA
colour: black

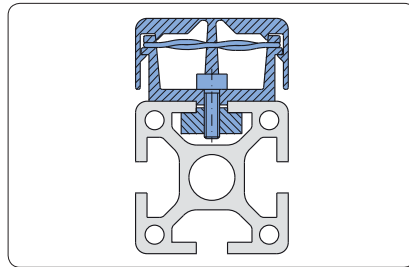

Mounting on profiles

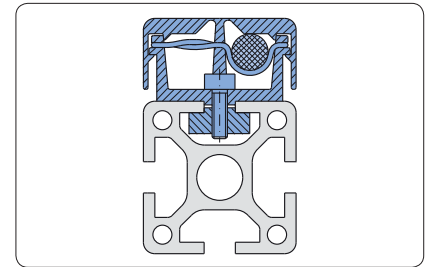

$\varnothing_{max} = 12$ mm for cables and hoses

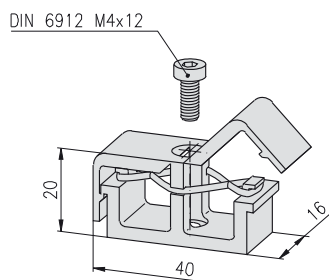

Fastening elements for E-slot

cap-screw DIN 6912 M4x12

T-Nut for subs. insertion, with leaf spring E, M4

spring-nut E, M4

T-slot nut E, M4

1.32.4EM4

1.33.EM4

1.34.10EM4

Description

Cable and hose clamp

Weight

8 g

Article-No.

1.71.1010

Block for cable binder,
Cross-blocks for cable binder
front-sided insertion,
Cable binder

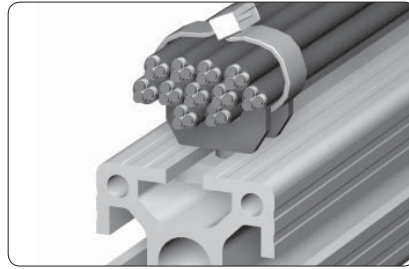

Block for cable binder

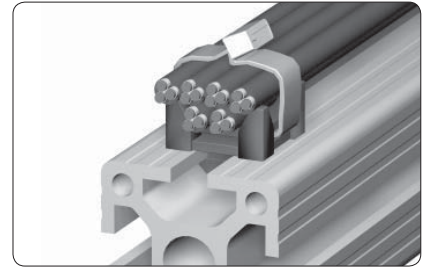

Cross-block for cable binder

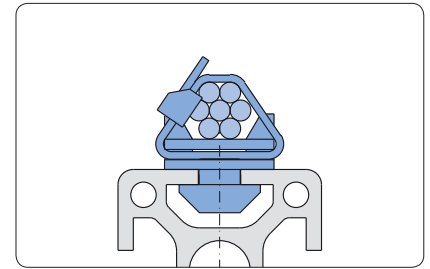
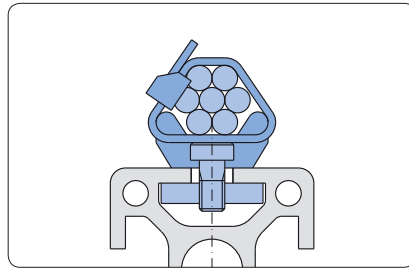

front-sided insertion

Technical data

material: PA
colour: black

Application

Element for fixing single cables and hoses or large quantities

Block for cable binder

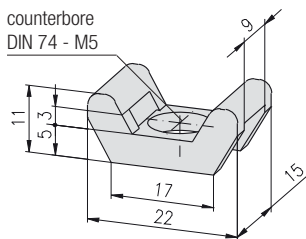

Comments

Counterbore DIN 74 - M5 for
cap-screw DIN 6912 - M5

Description

Block for cable binder

Weight

1.6 g

Article-No.

1.71.2010

Cross-blocks for cable binder
front-sided insertion

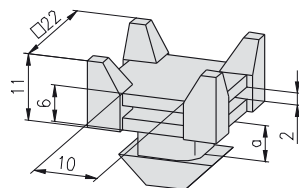

Description

Cross-block for cable binder F
Cross-block for cable binder E3
Cross-block for cable binder E4

a

2.2
3.0
4.0

Weight

4.0 g
4.0 g
4.0 g

Article-No.

1.71.2020F2
1.71.2020E3
1.71.2020E4

Cable binder
detachable

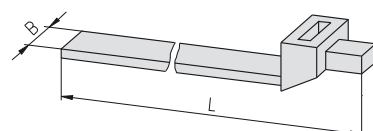

Description

Cable binder, detachable
Cable binder, detachable

B×L

4.8×190
9.0×140

Weight

1.0 g
1.9 g

Article-No.

1.71.2048190
1.71.2090140

Installation rings

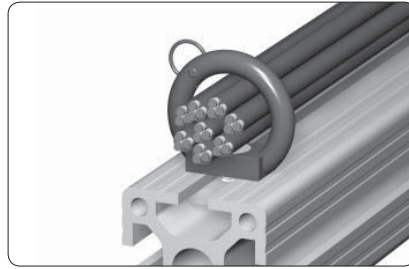

Application

Element for fixing large quantities of cables and hoses
The rings can be opened for insertion

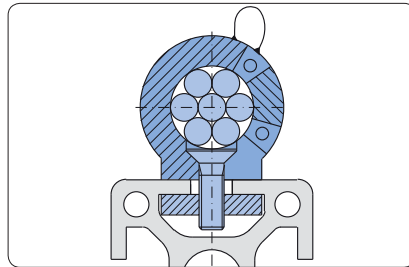

Technical data

material: PA-GF
colour: black

Comments

Delivery unit incl. screw

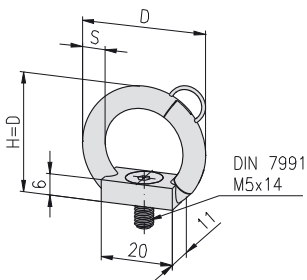

Description	D	s	Weight	Article-No.
Installation ring	Ø28.5	6.0	5 g	1.71.30285
Installation ring	Ø36.5	6.0	6 g	1.71.30365
Installation ring	Ø47.5	7.5	8 g	1.71.30475
Installation ring	Ø56.5	7.5	9 g	1.71.30565

Mounting set for 19" profile



Application

Fastening set for the assembly of 19" plug-in units and 19" profiles

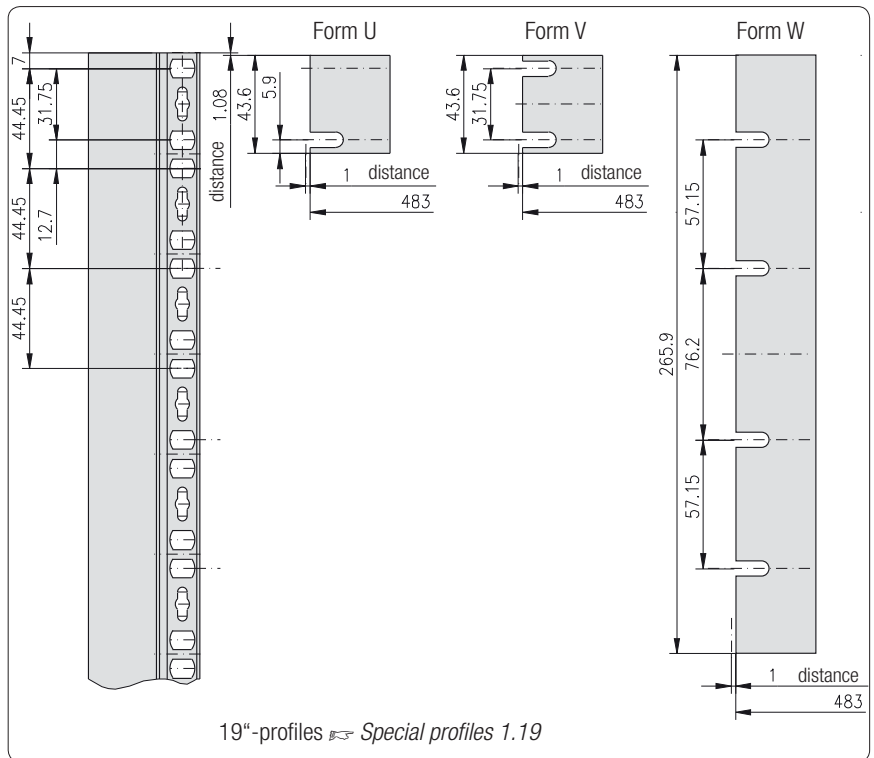
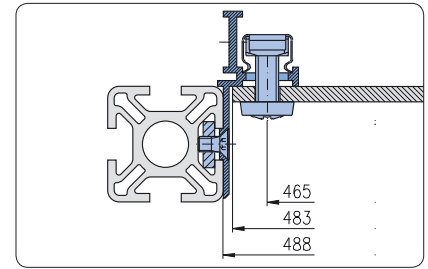
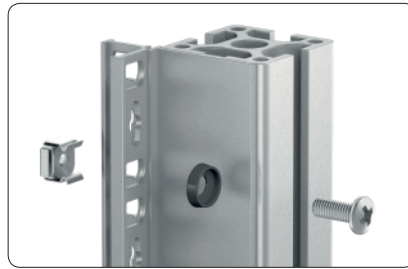

Dimensions for front panels and housings according to DIN 41494

Technical data

screw and nut: steel, galvanised
 plate and socket washer: PA, black
 delivery unit: PU with 10 mounting sets

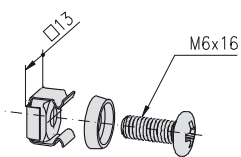

Description

Mounting set for 19" profile

Weight

70 g

Article-No.

1.72.2010.10

Safety switches

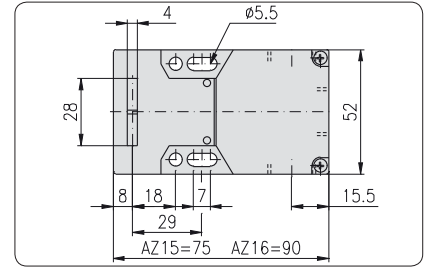
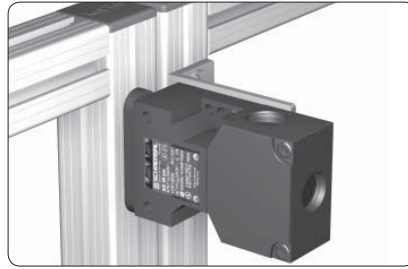

Application

Safety switch for the electrical interlocking of swinging or sliding doors

Comments

Smallest possible radius of operation of 150 mm

with 1 safety contact

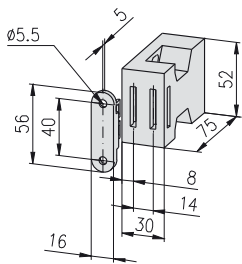

Technical data

Schmersal: Type AZ 15 zvrk-M16-2254
IP 67 230V 4A

Description

Safety switch with 1 safety contact
with 5 N - lock-in position

Weight

100 g

Article-No.

1.73.3010

with 1 safety contact and 1 alarm contact

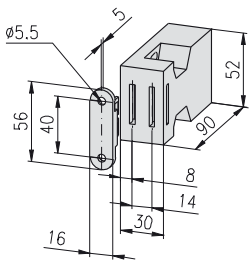

Technical data

Schmersal: Type AZ 16 zvrk-M16-2254
IP 67 230V 4A

Description

Safety switch with 1 safety contact and 1 alarm contact
with 5 N - lock-in position

Weight

125 g

Article-No.

1.73.3020

with 1 closing and 1 positioning monitoring

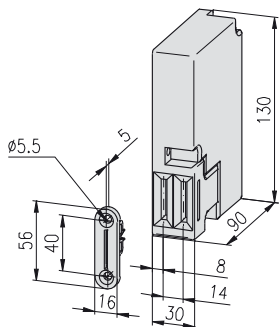

Technical data

Schmersal: Type AZM 161sk - 33rk-24V-M16
IP 65

Comments

Locking mechanism by spring
Releasing by solenoid
(closed-circuit system)
24V electrical potential of coil

Description

Safety switch with 1 closing and 1 positioning monitoring

Weight

480 g

Article-No.

1.73.3030

**Safety switches
AZ 17**

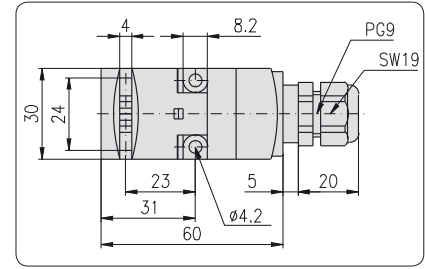
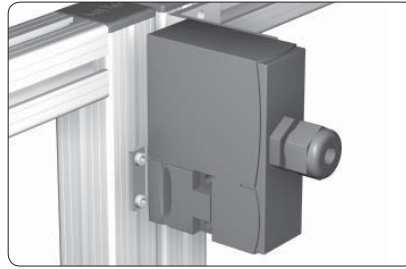

Application

Safety switch for the electrical interlocking of swinging or sliding doors

Technical data

Schmersal: Type AZ 17
4A / 230 VAC IP 67

Comments

Especially suitable for cramped mounting spaces

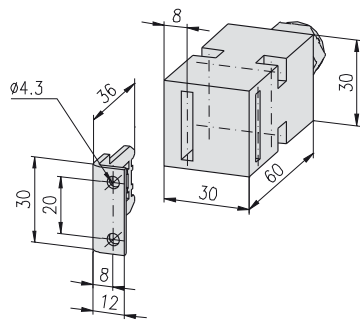

Description

Safety switch AZ 17-11 zk
with 1 positive-break safety contact
1 no contact

Weight

90 g

Article-No.

1.73.3111

Safety switch AZ 17-02 zk
with 2 positive-break safety contacts

90 g

1.73.3112

**Guard locking devices
AZM 170**

Technical data

Schmersal: Type AZM 170
4A / 230 VAC IP 67

Comments

Locking mechanism by spring
Releasing by solenoid
(closed-circuit system)

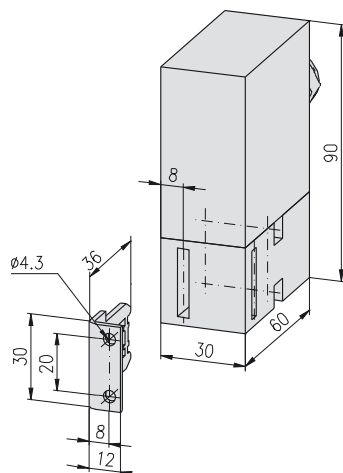

Description

Guard locking device AZM 170-11 zk - 024
with 1 positive-break safety contact
1 no contact
24V electrical potential of coil

Weight

300 g

Article-No.

1.73.3121

Guard locking device AZM 170-02 zk - 024
with 2 positive-break safety contacts
24V electrical potential of coil

300 g

1.73.3122

Comments

Locking mechanism by solenoid
Releasing by spring
(working current principle)

Description

Guard locking device AZM 170-11 zka
with 1 positive-break safety contact
1 no contact

Weight

300 g

Article-No.

1.73.3131

Guard locking device AZM 170-02 zka
with 2 positive-break safety contacts

300 g

1.73.3132

Safety interlocking-mountings for swinging door

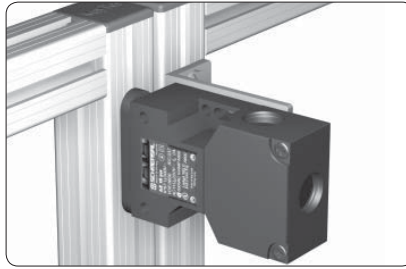

Application

Mounting element for electrical interlocking switches

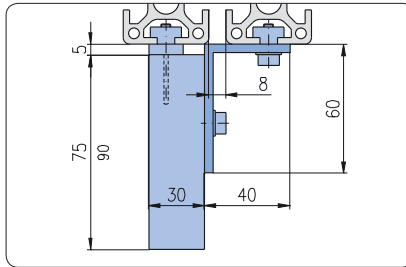

Comments

Assembly on
profile 30×30
profile 40×40
profile 40×80

Technical data

material: aluminium
surface: natural anodised

for swinging door

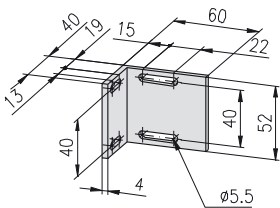

Description

Safety interlocking-mounting
for swinging door

Weight

46 g

Article-No.

1.73.4010

with lock for swinging door

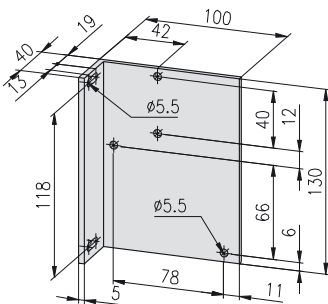

Description

Safety interlocking-mounting
with lock for swinging door

Weight

183 g

Article-No.

1.73.4020

Safety interlocking-mountings for sliding door

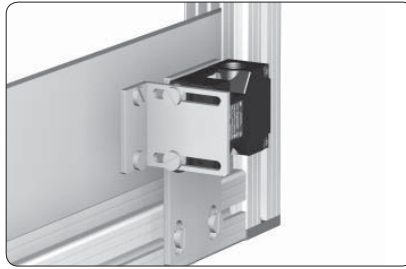

Application

Mounting element for the electrical interlocking of sliding doors

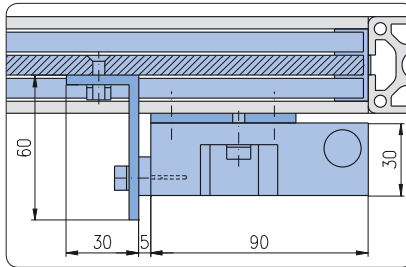

Comments

Assembly on profile 30×30
profile 40×40
profile 40×80

Technical data

material: aluminium
surface: natural anodised

Contact bracket-mounting for sliding door

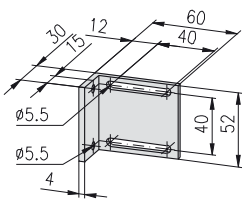

Description

Contact bracket-mounting for sliding door

Weight

41 g

Article-No.

1.73.4030

Safety interlocking-mounting for sliding door

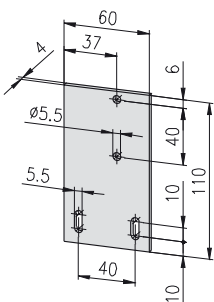

Description

Safety interlocking-mounting for sliding door

Weight

70 g

Article-No.

1.73.4040

**Safety interlocking-mountings
AZ 17
for swinging door**

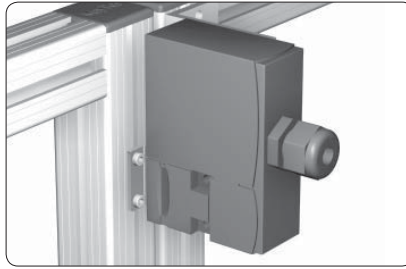

Application

- Fastening elements for:
- safety switches AZ 17
 - safety closing AZM 170 at sliding doors

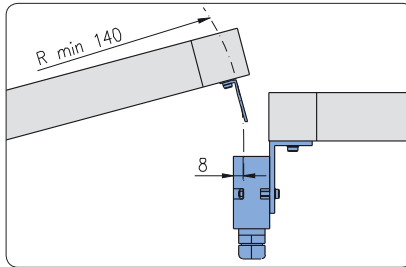

Activation key
Mounting vertical to swivel radius

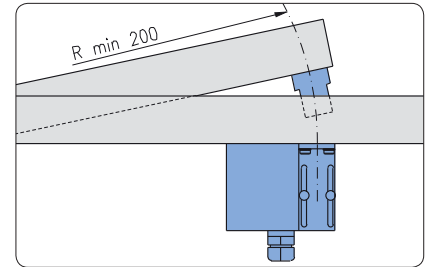

Activation key
Mounting horizontal to swivel radius

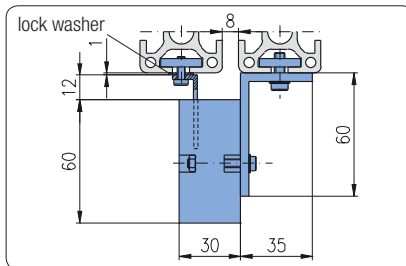

Comments

Assembly on
profile 30×30
profile 40×40
profile 40×80

Technical data

material: aluminium
surface: natural anodised

Delivery

Incl. lock washers DIN 9021 Ø4.3 mm
for mounting activation key

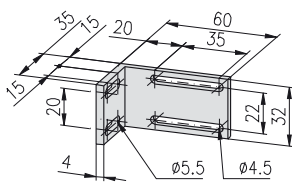

Description

Safety interlocking-mounting AZ 17
for swinging door

Weight

26 g

Article-No.

1.73.4110

**Safety interlocking-mountings
AZ 17
for sliding door**

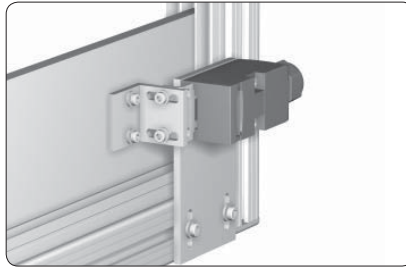

Application

- Fastening elements for:
- safety switches AZ 17
 - safety closing AZM 170 at sliding doors

Mounting position:

Safety switch parallel to sliding door

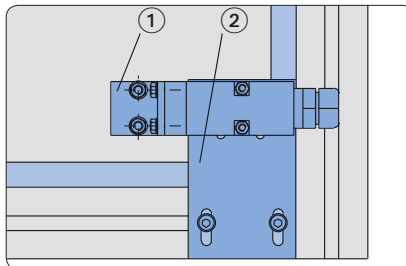

Fastening plate horizontal

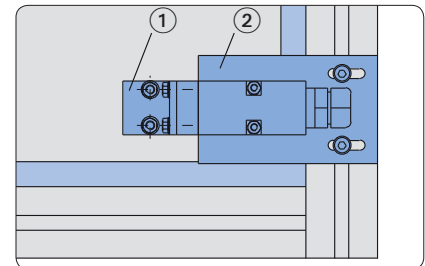

Fastening plate vertical

- ① Contact bracket-mounting AZ 17
- ② Safety interlocking-mounting AZ 17

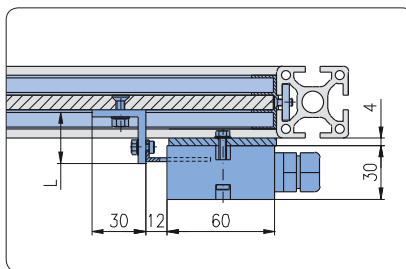

Mounting position:

Safety switch across to sliding door

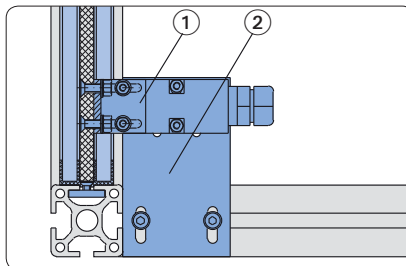

Fixing at cross profile

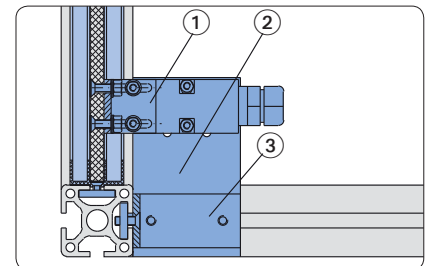

Fixing at longitudinal profile

- ① Contact bracket-mounting AZ 17
- ② Safety interlocking-mounting AZ 17
- ③ Angle for safety interlocking-mounting AZ 17

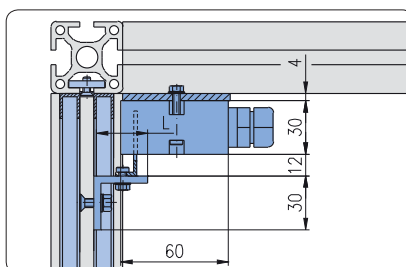

Safety interlocking-mountings AZ 17 for sliding door

Technical data

material: aluminium
surface: natural anodised

Comments

Assembly on
profile 30×30
profile 40×40
profile 40×80

Contact bracket-mounting AZ 17 for sliding door

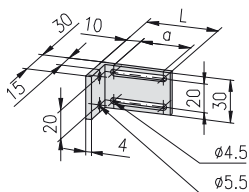

Description

Description	a	Weight	Article-No.
Contact bracket-mounting AZ 17 for sliding door, L 30	15	16 g	1.73.4123
Contact bracket-mounting AZ 17 for sliding door, L 40	25	19 g	1.73.4124
Contact bracket-mounting AZ 17 for sliding door, L 50	35	21 g	1.73.4125

Safety interlocking-mounting AZ 17 for sliding door

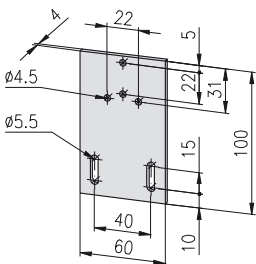

Description

Description	Weight	Article-No.
Safety interlocking-mounting AZ 17 for sliding door	62 g	1.73.4130

Angle for safety interlocking-mounting AZ 17 for sliding door

Comments

Countersink DIN 74 - M5 for
countersunk screw DIN 7991 - M5

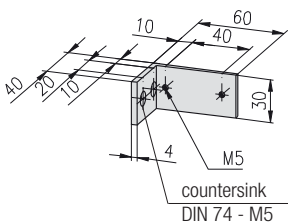

Description

Description	Weight	Article-No.
Angle for safety interlocking-mounting AZ 17 for sliding door	30 g	1.73.4140

Sensor brackets

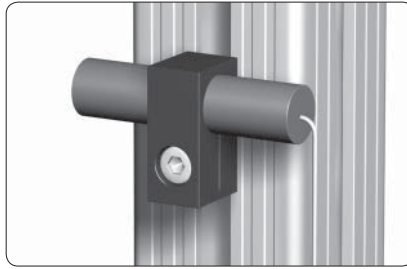

Application
For fastening of sensors

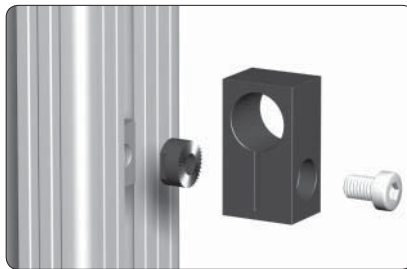

Assembly
The toothed lock washer is fixed in profile slot and guarantees a reliable positioning

Technical data

material: PA, black

Fastening elements

cap-screw DIN 6912, M4

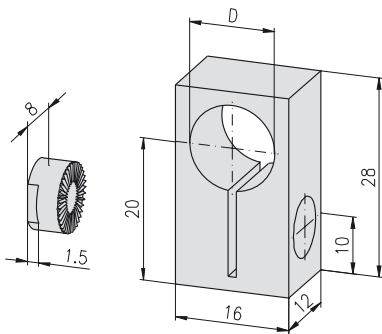

Description	D	Weight	Article-No.
Sensor bracket 8	Ø6.5	5.5 g	1.73.80806
Sensor bracket 8	Ø8	5.4 g	1.73.80808
Sensor bracket 8	Ø12	4.6 g	1.73.80812

Electrical installation trunking

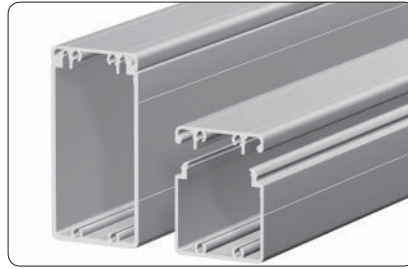

Application

Installation trunking for electrical and pneumatic lines

Technical data

material: aluminium
surface: natural anodised

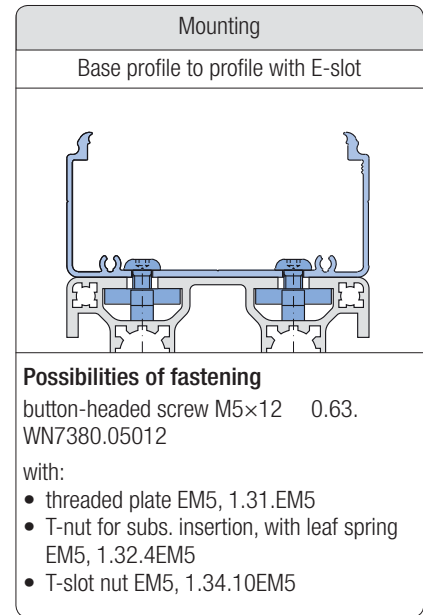
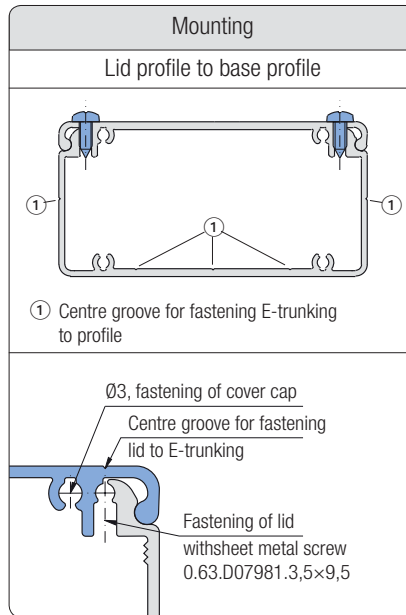

E-trunking

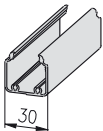

Description	Weight	Article-No.
E-trunking 30×30, bar 6 m	2.28 kg	1.19.203030G.60
E-trunking 30×30, cut to length	0.38 kg/m	1.19.203030G-A00A00/... /... = length in mm

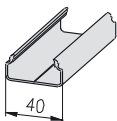

Description	Weight	Article-No.
E-trunking 40×20, bar 6 m	1.80 kg	1.19.204020G.60
E-trunking 40×20, cut to length	0.30 kg/m	1.19.204020G-A00A00/... /... = length in mm

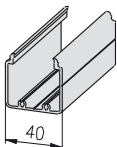

Description	Weight	Article-No.
E-trunking 40×40, bar 6 m	3.66 kg	1.19.204040G.60
E-trunking 40×40, cut to length	0.61 kg/m	1.19.204040G-A00A00/... /... = length in mm

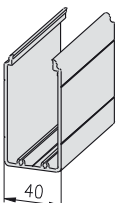

Description	Weight	Article-No.
E-trunking 40×80, bar 6 m	7.20 kg	1.19.204080G.60
E-trunking 40×80, cut to length	1.20 kg/m	1.19.204080G-F00F00/... /... = length in mm

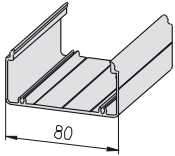

Description	Weight	Article-No.
E-trunking 80×40, bar 6 m	5.10 kg	1.19.208040G.60
 E-trunking 80×40, cut to length	0.85 kg/m	1.19.208040G-F00F00/... /... = length in mm

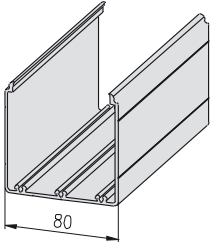

Description	Weight	Article-No.
E-trunking 80×80, bar 6 m	9.30 kg	1.19.208080G.60
 E-trunking 80×80, cut to length	1.55 kg/m	1.19.208080G-F00F00/... /... = length in mm

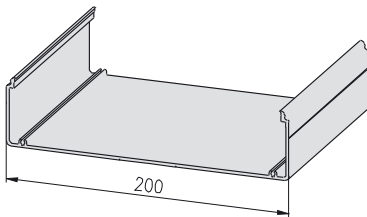

Description	Weight	Article-No.
E-trunking 200×50, bar 6 m	12.00 kg	1.19.220050G.60
 E-trunking 200×50, cut to length	2.0 kg/m	1.19.220050G-L00L00/... /... = length in mm

E-trunking, lids

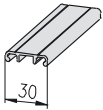

Description	Weight	Article-No.
E-trunking, lid 30, bar 6 m	1.44 kg	1.19.2030D.60
 E-trunking, lid 30, cut to length	0.24 kg/m	1.19.2030D-A00A00/... /... = length in mm

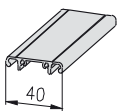

Description	Weight	Article-No.
E-trunking, lid 40, bar 6 m	2.10 kg	1.19.2040D.60
 E-trunking, lid 40, cut to length	0.35 kg/m	1.19.2040D-A00A00/... /... = length in mm

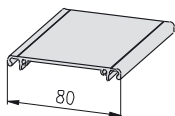

Description	Weight	Article-No.
E-trunking, lid 80, bar 6 m	3.54 kg	1.19.2080D.60
 E-trunking, lid 80, cut to length	0.59 kg/m	1.19.2080D-F00F00/... /... = length in mm

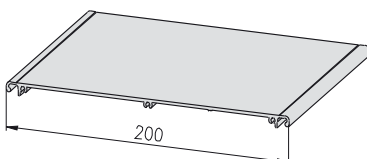

Description	Weight	Article-No.
E-trunking, lid 200, bar 6 m	9.00 kg	1.19.2200D.60
 E-trunking, lid 200, cut to length	1.50 kg/m	1.19.2200D-L00L00/... /... = length in mm

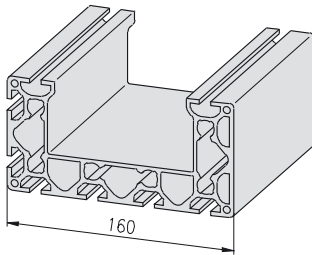
E-trunking

Description	Weight	Article-No.
Profile 80×160, 8E, SP, bar 6 m	47.40 kg	1.11.080160.89SP.60
 Profile 80×160, 8E, SP, cut to length	7.90 kg/m	1.11.080160.89SP-L00L00/... /... = length in mm

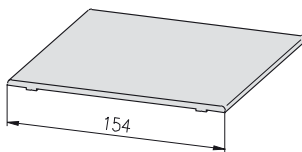
E-trunking, lid

Description	Weight	Article-No.
Profile pre-cut lid 120, bar 6 m	10.80 kg	1.19.1101120.60
 Profile pre-cut lid 120, cut to length	1.80 kg/m	1.19.1101120-L00L00/... /... = length in mm

E-trunking, end plates
Technical data

material: stainless steel

surface: pickled and passivated

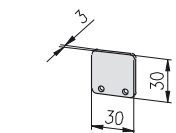

Description	Weight	Article-No.
E-trunking, end plate 30×30	6.0 g	1.75.2030302

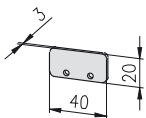

Description	Weight	Article-No.
E-trunking, end plate 40×20	6.0 g	1.75.2040202

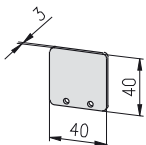

Description	Weight	Article-No.
E-trunking, end plate 40×40	12.3 g	1.75.2040402

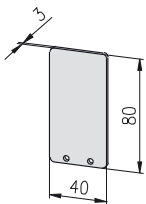

Description	Weight	Article-No.
E-trunking, end plate 40×80	25.0 g	1.75.2040802

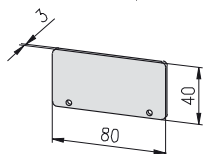

Description	Weight	Article-No.
E-trunking, end plate 80×40	25.0 g	1.75.2080402

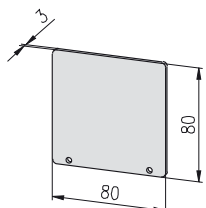

Description	Weight	Article-No.
E-trunking, end plate 80×80	48.0 g	1.75.2080802

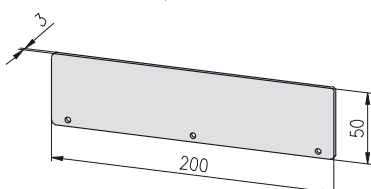

Description	Weight	Article-No.
E-trunking, end plate 200×50	80.7 g	1.75.2200503

Electrical installation trunking for clips

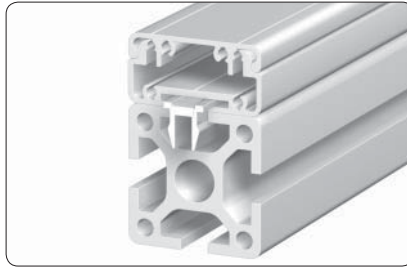

Application

Clip-system for quick assembly of the E-trunking

Technical data

material: aluminium
surface: natural anodised

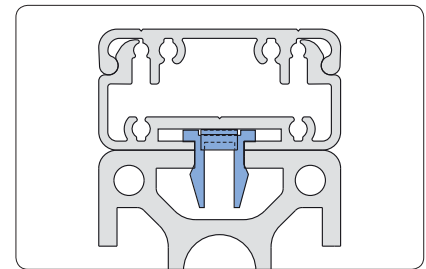
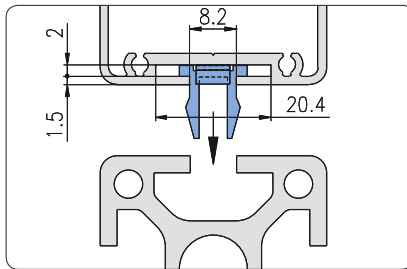

E-trunking, for clips

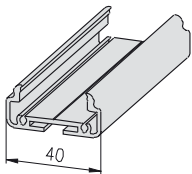

Description

E-trunking 40×20, Clips, bar 6 m

Weight

3.00 kg

Article-No.

1.19.214020G.60



E-trunking 40×20, Clips, cut to length

0.50 kg/m

1.19.214020G-A00A00/...
/... = length in mm

E-trunking, lid

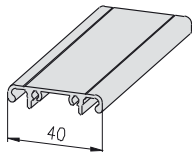

Description

E-trunking, lid 40, bar 6 m

Weight

2.10 kg

Article-No.

1.19.2040D.60



E-trunking, lid 40, cut to length

0.35 kg/m

1.19.2040D-A00A00/...
/... = length in mm

E-trunking, end plate

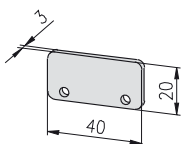

Technical data

material: stainless steel
surface: pickled and passivated

Description

E-trunking, end plate 40×20, Clips

Weight

6.0 g

Article-No.

1.75.2140202

Clip for E-trunking

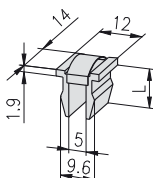

Technical data

material: Murytal C
colour: natural

Description

Clip E3

L

11

Weight

3.0 g

Article-No.

1.75.1000E3

Clip E4

L

12

3.0 g

1.75.1000E4

**Corner elements
for wire net mounting profile**

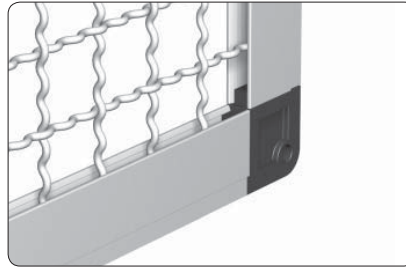

Application

This mounting profile allows simple and safe installation of screens

Comments

Wire net mounting profile ↗ 1.19.1423...

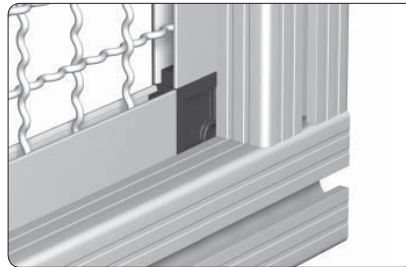

Mounting in the profile slot

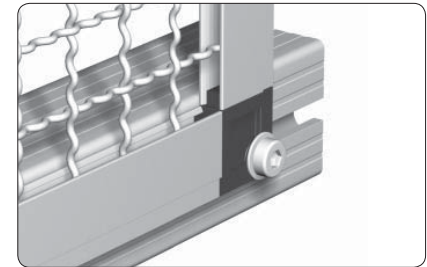

Fastening from the outside

Technical data

material: PA - GF
colour: black

Outside corner

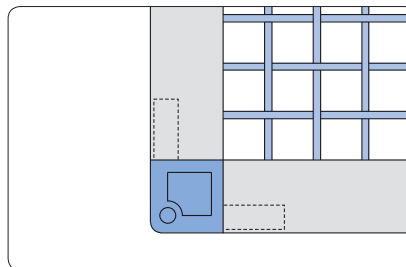
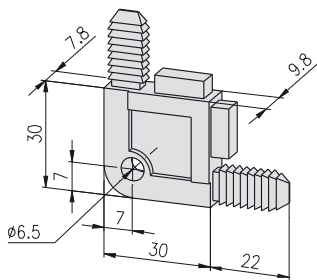

Outside corner

Description

Corner element - outside

Weight

13 g

Article-No.

1.81.1010

Inside corner

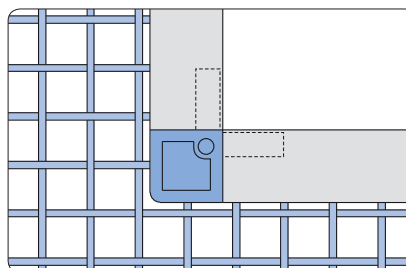
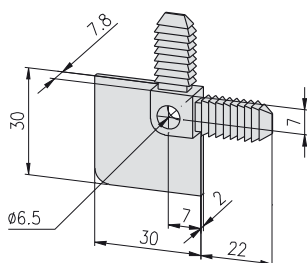

Inside corner

Description

Corner element - inside

Weight

6 g

Article-No.

1.81.1020

**Corner element 33
for wire net mounting profile 33×10**

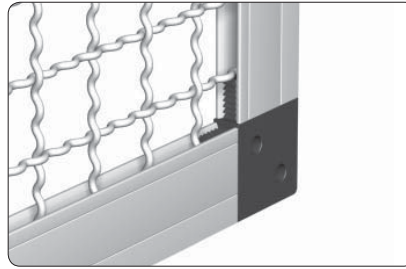

Application

This profile allows simple and safe installation of wire nets

Comments

Wire net mounting profile 33×10
[↗ 1.19.1423...](#)

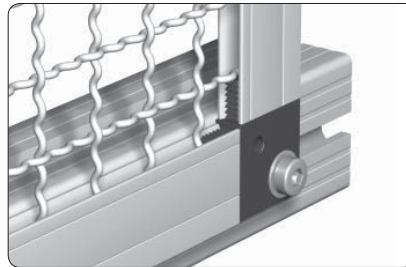

Outside mounting

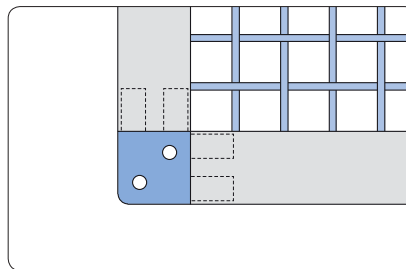

Outside corner

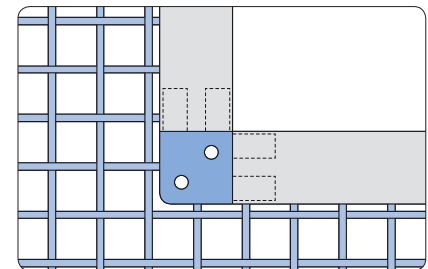

Inside corner

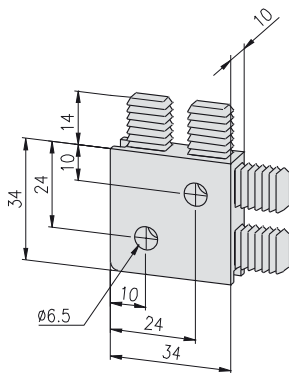

Technical data

material: PA - GF
 colour: black

Description

Corner element 33

Weight

16 g

Article-No.

1.81.23310

Mounting sockets

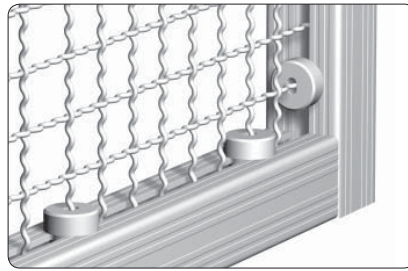

Application

For stable and vibration free fastening of wire nets

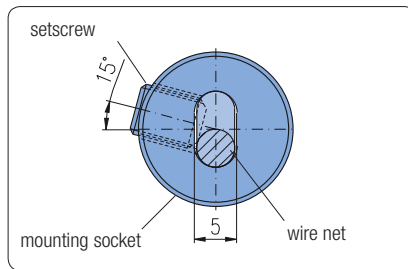
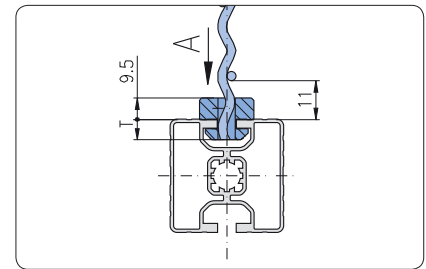
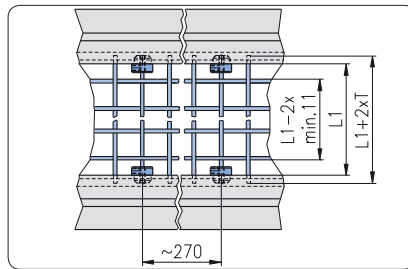

View „A“

Assembly

- plug terminal sockets at a distance of about 270 mm on the wire net
- push on profile
- rotate mounting sockets with headless setscrew DIN 913 M6×8 at an angle of 15°

Technical data

material:
 mounting socket: aluminium, natural anodised
 setscrew: steel, galvanised

Delivery unit

Mounting socket incl. setscrew

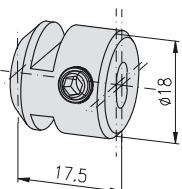
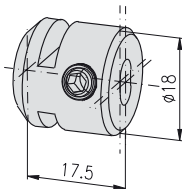
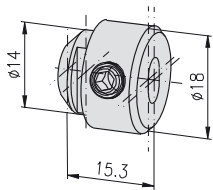

Description	T	Weight	Article-No.
Mounting socket, F	5	6 g	1.81.510F

Description	T	Weight	Article-No.
Mounting socket, E3	8	6 g	1.81.510E3

Description	T	Weight	Article-No.
Mounting socket, E4	8	6 g	1.81.510E4

Panel elements

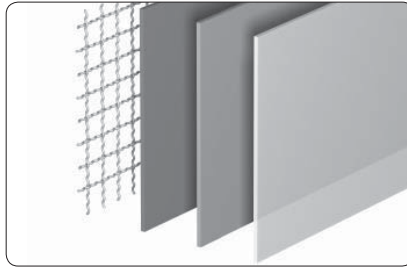

Application

Panel elements to cover machine frames, work stations, partition walls.



Panel element, fixing directly in the slot

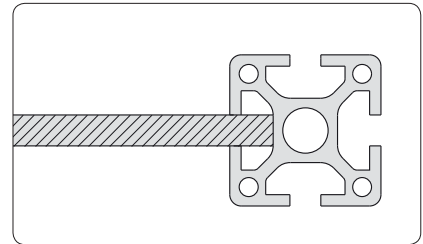

Installation accessories ↗ 1.41



Panel elements close to the outer contour by subsequent slitting of the profiles

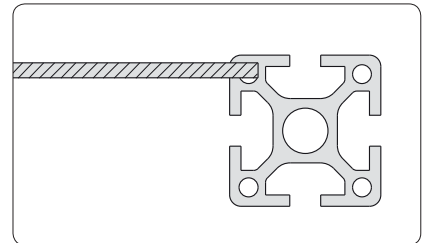

Special slits ↗ 1.1E.01



Panel elements close to the outer contour by applying panel profiles

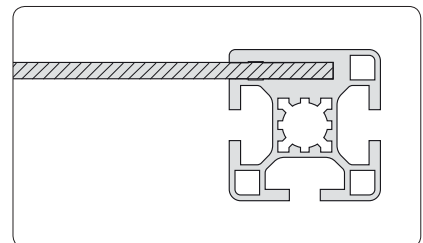

Panel profiles ↗ 1.14

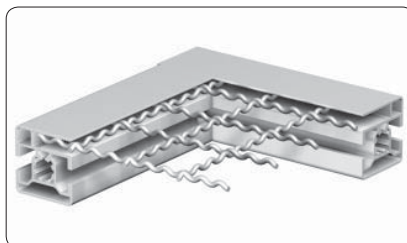

Panel elements close to the outer contour by applying wire net profiles

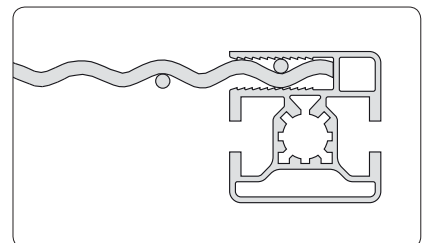

Wire net profiles ↗ 1.15

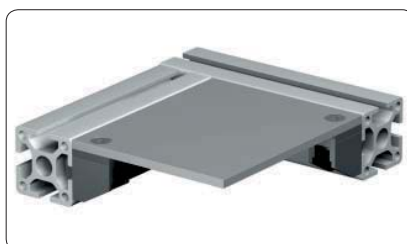

Panel elements close to the outer contour by fixing with angle or mounting block

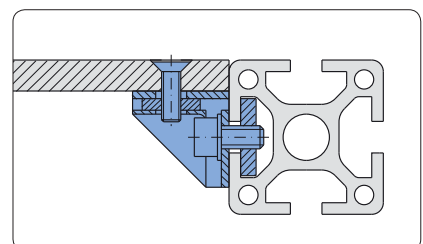

Mounting blocks ↗ 1.64

Chipboards
both sides coated with melamine

Technical data	
surface:	both sides coated with melamine
structure:	pearl
RAL 9002:	grey-white
formaldehydmission:	complies to safety standards §9 paragraph 3
light-fastness:	point 6 as per DIN 53799
temperature resistance:	- 25°C to 130°C
chemical resistance:	resistant against organic food, light acid contents and alkaline solution, gasoline, oil, tested as per DIN 53799
chipboard:	high frequency glued laminated chipboard
Technical values on DIN 68765 and 53799	
bulk density:	approx. 700 kg/m ³
thickness tolerance:	+0.5 -0.3 mm
weight:	S = 8 mm 5.6 kg/m ² S = 16 mm 11.2 kg/m ² S = 19 mm 13.3 kg/m ²
cut to length:	1.82.□□□-99/□□□□×□□□□ type 1.82.□□□-99/□□□□×□□□□ length×width in mm 1.82.□□□-99/□□□□×□□□□

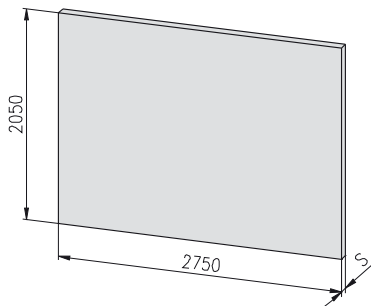

Description	S	RAL	Weight	Article-No.
Chipboard	8	9002	32 kg	1.82.083.00
Chipboard	16	9002	64 kg	1.82.163.00
Chipboard	19	9002	75 kg	1.82.193.00

Solid plastic panels
coated with melamine

Technical data	
surface:	both sides coated with melamine
structure:	pearl
RAL 9002:	grey-white
solid plastic panel:	made of Phenolplastic high pressure plate (HPL) of laminated material with all generally known merits of this substance.
Technical values on DIN 19926 and 53799	
bulk density:	approx. 1,500 kg/m ³
thickness tolerance:	-0.6 mm
weight:	S = 4 mm 6 kg/m ² S = 8 mm 12 kg/m ²
cut to length:	1.83.□□□-99/□□□□×□□□□ type 1.83.□□□-99/□□□□×□□□□ length×width in mm 1.83.□□□-99/□□□□×□□□□

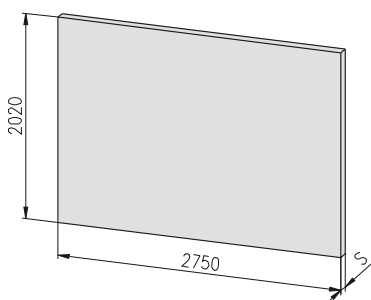

Description	S	RAL	Weight	Article-No.
Solid plastic panel	4	9002	33 kg	1.83.043.00
Solid plastic panel	8	9002	66 kg	1.83.083.00

Alu-plastic composite panels

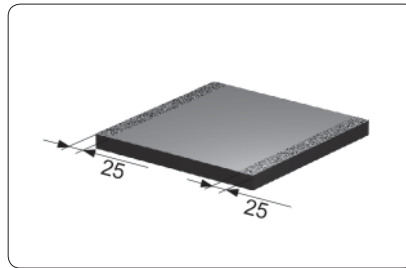

Comments

The anodised composite panels have contact strips of 25 mm width on the short sides.

Technical data	
alu-plastic composite panel:	PE with alu coating on both sides
surface:	natural anodised, E6/EV1
temperature resistance:	- 50°C to 80°C
chemical resistance:	resistant against organic food, light acid contents and alkaline solutions, gasoline, oil
thickness tolerance:	-0.6 mm
weight:	S = 4 mm 5.5 kg/m ² S = 6 mm 7.3 kg/m ²
cut to length:	1.85.□□□-99/□□□□×□□□□ 1.85.□□□-99/□□□□×□□□□ type 1.85.□□□-99/□□□□×□□□□ length×width in mm

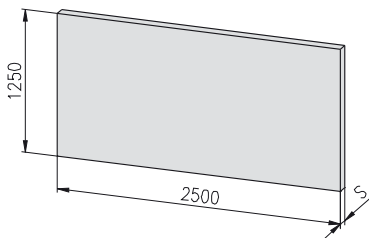

Description	S	Weight	Article-No.
Alu-plastic composite panel	4	17.2 kg	1.85.040.00
Alu-plastic composite panel	6	22.8 kg	1.85.060.00

Acrylic

Application

Doors, panels and guards

Technical data	
thickness tolerance:	± 5%
weight:	S = 4 mm 4.8 kg/m ² S = 6 mm 7.2 kg/m ² S = 8 mm 9.6 kg/m ²
cut to length:	1.86.□□□-99/□□□□×□□□□ 1.86.□□□-99/□□□□×□□□□ type 1.86.□□□-99/□□□□×□□□□ length×width in mm

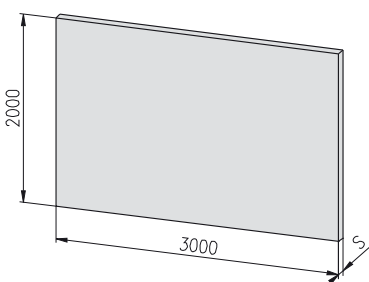

Description	S	Colour	Weight	Article-No.
Acrylic xt	4	transparent	28.8 kg	1.86.041.00
Acrylic xt	4	bronze 802	28.8 kg	1.86.042.00
Acrylic xt	6	transparent	43.2 kg	1.86.061.00
Acrylic xt	6	bronze 802	43.2 kg	1.86.062.00
Acrylic xt	8	transparent	57.6 kg	1.86.081.00
Acrylic xt	8	bronze 802	57.6 kg	1.86.082.00

Polycarbonate (Makrolon)

Application

Doors, panels and guards with stringent security requirements as polycarbonate offers high impact resistance and strength against breakage

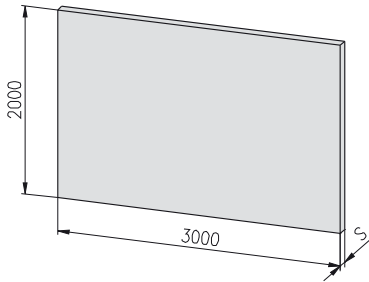

Technical data	
thickness tolerance:	+0.8 mm
weight:	S = 4 mm 4.8 kg/m ² S = 6 mm 7.2 kg/m ² S = 8 mm 9.6 kg/m ²
cut to length:	1.87.□□□-99/□□□□×□□□□ 1.87.□□□-99/□□□□×□□□□ type 1.87.□□□-99/□□□□×□□□□ length×width in mm

Description	S	Colour	Weight	Article-No.
Polycarbonate	4	transparent	28.8 kg	1.87.041.00
Polycarbonate	4	bronze 775	28.8 kg	1.87.042.00
Polycarbonate	6	transparent	43.2 kg	1.87.061.00
Polycarbonate	6	bronze 775	43.2 kg	1.87.062.00
Polycarbonate	8	transparent	57.6 kg	1.87.081.00
Polycarbonate	8	bronze 775	57.6 kg	1.87.082.00

Properties		Acrylic xt	Poly- carbonate
Mechanical properties			
	20°C		
maximum extent of flex	MN/m ²	107.9	68.7
break / shear point	%	5.5	> 110.0
compression	MN/m ²	117.7	78.5
elasticity	MN/m ²	3,188.0	2,256.0
marring resistance	J/m ²	29.4	392.4
impact resistance	kJ/m ²	19.6	no break
tensile strength	MN/m ²	73.6	68.7
Thermal properties			
temperature distortion according to 'Vicat'	°C	110	170
melting point	°C	168	170
temperature range under static load (max.)	°C	70	130
temperature range under static load (min.)	°C	-40	-100

Wire net, Alu

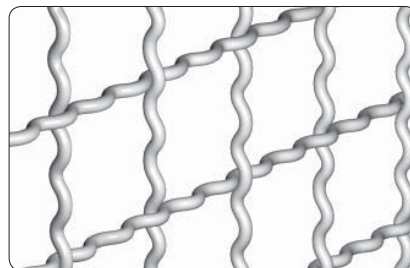

Application

For protective coverings and partition walls

Comments

Mounting in the profile:

- with sponge rubber ↗ 1.41.6□□
- with wire net m. prof. ↗ 1.19.1423...
- with wedge profile ↗ 1.41.51E□.□
- with framing profile ↗ 1.41.710.□
- with mounting sockets ↗ 1.81.510□□

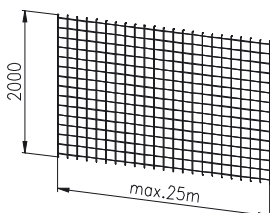

Technical data	
material:	Aluminium
surface:	bare
weight:	3×20×20 mm 1.85 kg/m ² 4×30×30 mm 2.25 kg/m ²
length of ring:	25 m
cut to length:	1.88.□□□-99/□□□□×□□□□ 1.88.□□□-99/□□□□×□□□□ type 1.88.□□□-99/□□□□×□□□□ length×width in mm

Description	Weight	Article-No.
Wire net, Alu 3×20×20	92.5 kg	1.88.322.00
Wire net, Alu 4×30×30	112.5 kg	1.88.433.00

Wire net, steel

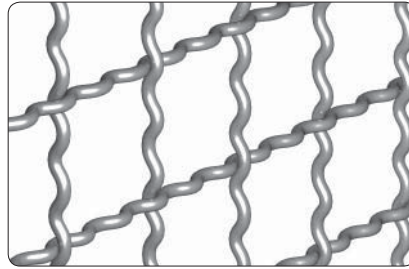

Application

For protective coverings and partition walls

Comments

Mounting in the profile:

- with sponge rubber 1.41.6□□
- with wire net m. prof. 1.19.1423...
- with wedge profile 1.41.51E□.□
- with framing profile 1.41.710.□
- with mounting sockets 1.81.510□□

Technical data	
material:	steel
surface:	galvanised
weight:	4×30×30 mm 27 kg/plate 4×40×40 mm 24 kg/plate
size of plate:	3,000×1,810 mm
cut to length:	1.88.□□□-99/□□□□×□□□□ 1.88.□□□-99/□□□□×□□□□ type 1.88.□□□-99/□□□□×□□□□ length×width in mm

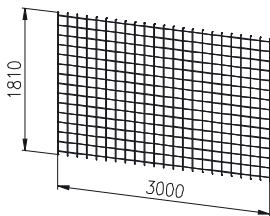

Description	Weight	Article-No.
Wire net, steel 4×30×30	27 kg	1.88.143030.00
Wire net, steel 4×40×40	24 kg	1.88.144040.00

Grid, steel welded



Application

For protective coverings and partition walls

Comments

Mounting in the profile:

- with sponge rubber 1.41.6□□
- with wire net m. prof. 1.19.1423...
- with wedge profile 1.41.51E□.□
- with framing profile 1.41.710.□
- with mounting sockets 1.81.510□□

Technical data	
material:	steel
surface:	electrogalvanised
weight:	3×25×25 mm 8.9 kg/plate 4×40×40 mm 9.8 kg/plate
size of plate:	2,000×1,000 mm
cut to length:	1.88.□□□-99/□□□□×□□□□ 1.88.□□□-99/□□□□×□□□□ type 1.88.□□□-99/□□□□×□□□□ length×width in mm

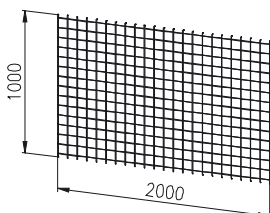

Description	Weight	Article-No.
Grid, steel 3×25×25	8.9 kg	1.88.232525.00
Grid, steel 4×40×40	9.8 kg	1.88.244040.00

Self locking washers
DIN 25201

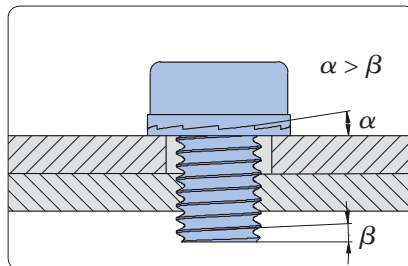
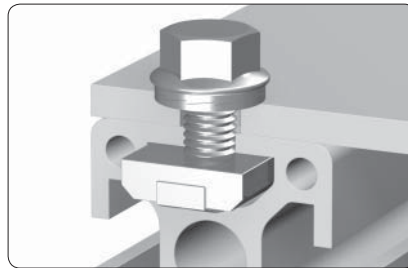

The cam angle α of the washers is larger than the thread pitch β of the bolt.

Advantages

- Maximum safety during the tightening of the screw
- Reliable connection under extreme vibration and dynamic loads
- Ease of assembly and disassembly
- Positive locking at low and high preload levels
- Same temperature characteristics as standard nut & bolt
- Surface protection
- Reusable

The outside dimensions of the locking washer guarantees it's effectiveness even when used in countersunk holes. Washers with enlarged outer diameter (SP) in combination with flanged nuts / bolts are recommended for use on large / long holes, painted surfaces or soft materials, e.g. aluminium.

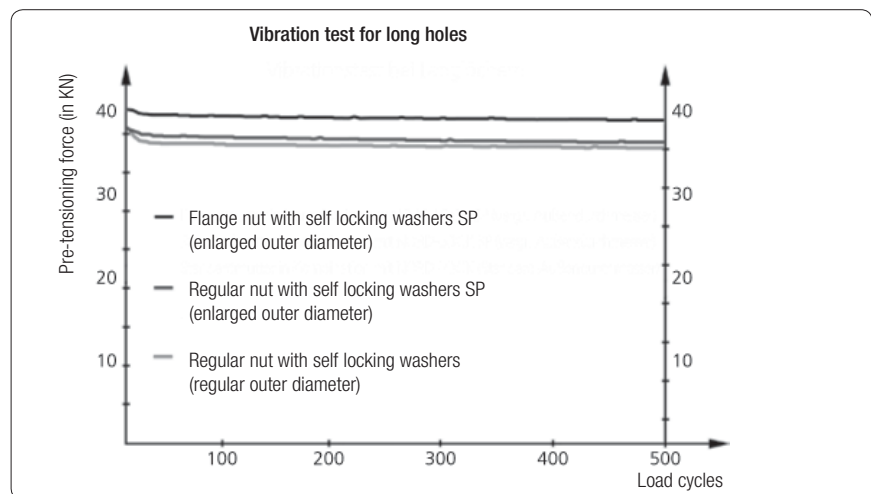

Junker vibration test for bolt M12 (8.8)

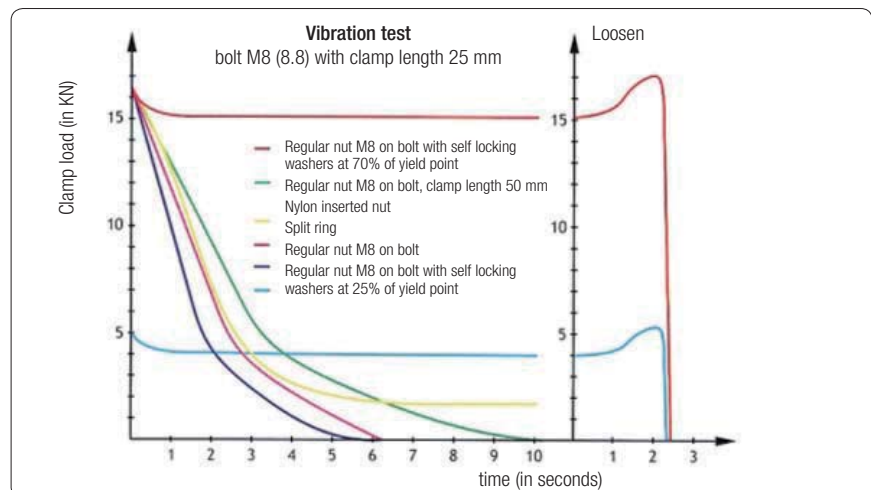

Test results

Self locking washers
standard

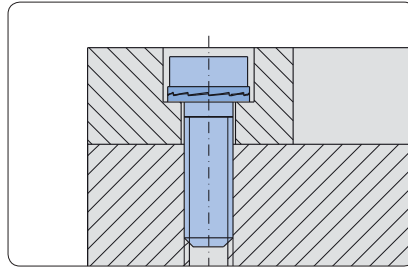

Cylindrical head screw DIN 6912 with self locking washers, standard

Self locking washers SP
(enlarged outer diameter)

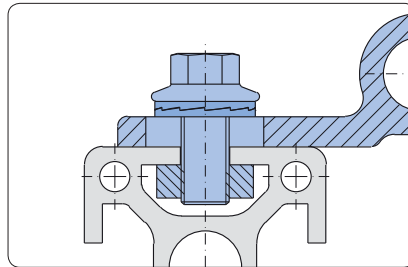

Hexagonal flange head screw DIN 6912 and self locking washers SP

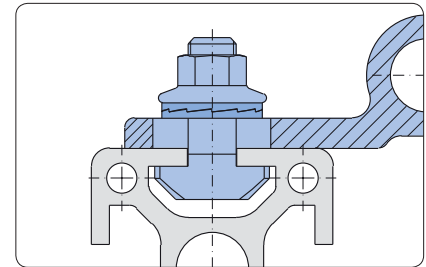

T-screw with flange nut DIN 6923 and self locking washers SP

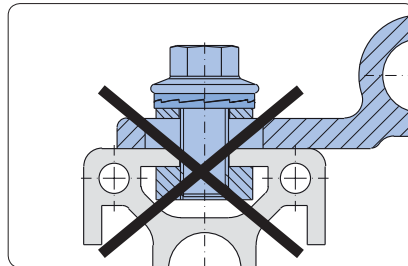

Do not use washers that are not secured in position

Technical data

material:

- steel: Zinc flake coated, pre-assembled in pairs (glued)
- stainless steel: 1.4404, pre-assembled in pairs (glued)

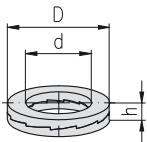

Description	D	h	d	Weight	Article-No.
Standard / steel					
Self locking washers, M6	10.8	1.8	6.5	0.7 g	0.62.D2520106
Self locking washers, M8	13.5	2.5	8.7	1.5 g	0.62.D2520108
Self locking washers, M10	16.6	2.5	10.7	2.3 g	0.62.D2520110
Standard / stainless steel					
<input type="checkbox"/> <input type="checkbox"/> Self locking washers, M6, SS	10.8	2.2	6.5	0.9 g	0.62.D2520106SS
<input type="checkbox"/> <input type="checkbox"/> Self locking washers, M8, SS	13.5	2.2	8.7	1.2 g	0.62.D2520108SS
<input type="checkbox"/> <input type="checkbox"/> Self locking washers, M10, SS	16.6	2.2	10.7	1.6 g	0.62.D2520110SS
SP / steel					
Self locking washers, M6, SP	13.5	2.5	6.5	2.0 g	0.62.D2520106SP
Self locking washers, M8, SP	16.6	2.5	8.7	2.9 g	0.62.D2520108SP
Self locking washers, M10, SP	21.0	2.5	10.7	4.4 g	0.62.D2520110SP
SP / stainless steel					
<input type="checkbox"/> <input type="checkbox"/> Self locking washers, M6, SPSS	13.5	2.2	6.5	1.6 g	0.62.D2520106SPSS
<input type="checkbox"/> <input type="checkbox"/> Self locking washers, M8, SPSS	16.6	2.2	8.7	2.4 g	0.62.D2520108SPSS
<input type="checkbox"/> <input type="checkbox"/> Self locking washers, M10, SPSS	21.0	2.2	10.7	3.7 g	0.62.D2520110SPSS

Button head screws

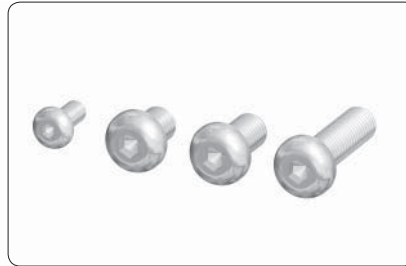
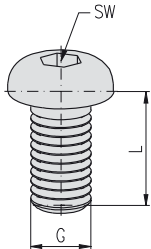
Application

Button head screws for the mounting of additional elements

Technical data

material: steel
surface: galvanised

Description	G×L	Weight	Article-No.
Button head screw	M5×12	2.4 g	0.63.WN7380.05012
Button head screw	M8×12	6.5 g	0.63.WN7380.08012
Button head screw	M8×18	8.5 g	0.63.WN7380.08018
Button head screw	M8×30	12.6 g	0.63.WN7380.08030

Tools

1.98

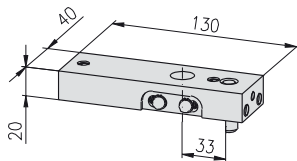
 Press in device
for knurled cross bushing

Technical data

Base body:
 • material: aluminium
 • surface: natural anodised
 Axle bolt, spring:
 • material: stainless steel
 Other:
 • material: steel
 • surface: galvanised

Description	Weight	Article-No.
Press in device for knurled cross bushing	310.0 g	1.98.11.21.B00R

Single parts	Pcs	Weight	Article-No.
Base body	1	216.0 g	1.98.11.21.B00R/01
Stopping pin	1	21.2 g	1.99.01112-05
Set screw for stop pin	1	1.8 g	1.99.01112-06
Dowel pin ISO 8752 (DIN 1481), 8×24 (for drill jig)	2	6.5 g	0.69.I08752.08024
Axle bolt complete, Ø8g 6×35 mm	2	15.6 g	1.98.11.21.B00R/05
Hex-socket set screw, DIN 913, M8×25	4	6.6 g	0.63.D00913.08025
Spring for T-screw, E	4	0.1 g	1.34.E00/02

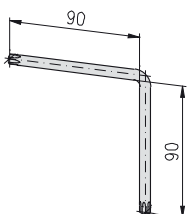
Tx screw driver



Technical data

material: steel, hardened
surface: nickel-plated

Description	Weight	Article-No.
Tx screw driver for Torx 40 screws	54.0 g	1.98.T40.090090

Cross bushings / Anchors		Drill									Milling cutter					
		MK		cylindrical shaft							cylindrical shaft					
		1.99.03115452	1.99.03115454	1.99.0310800	1.99.0310645	1.99.03109000	1.99.03109452	1.99.0311245	1.99.03215452	1.99.03215454	1.99.0210645	1.99.02109000	1.99.02109452	1.99.02112451	1.99.02115000	1.99.02115452
drill-Ø	15.25	15.25	6/8.5	6.2	9.2	9.2	12.2	15.25	15.25	6.2	9.2	9.2	12.2	15.25	15.25	15.25
chaf. ×45°	1.5	3.5	-	2.0	-	1.5	2.0	1.5	3.5	2.0	-	1.5	1.0	-	1.5	3.5
shaft-Ø	MK	MK	8.5	6.2	9.2	9.2	12.2	12.0	12.0	10.0	10.0	10.0	12.0	16.0	16.0	16.0
Slot	Description															
Cross bushing																
H F E	Standard															
H F E	for profile 20×20, soft															
H F E	Standard															
H F E	for profile • 30×30, soft • 30×100 • 30×150															
H F E	for profile 40×40, 2E 45°, LP															
H F E	for ST-Connector, profile 30×150															
H F E	for SE-Connector															
H F E	for ST-Connector															
H F E	for ST-Connector with anchor, screw-type															
Anchor																
H F E	for connector, parallel															
H F E	for connector, parallel															
H F E	for connector, miter, hinge															

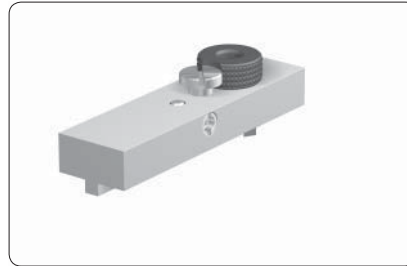
**Drill jigs
for profiles with H-slots**



Drill jig with setscrew

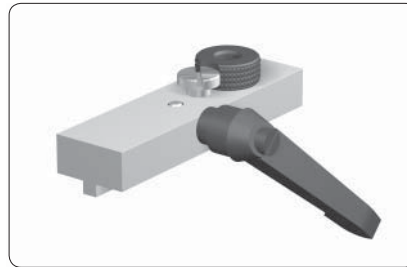

Drill jig with clamping lever

Application

Tools for precise machining of connection bore

- for drilling machine: - drill jig
- drill
- for milling machine: - milling cutter
- the drill jig is located and fastened in the profile slot
- suitable for any profile angle cut

Technical data

Base body:

- material: aluminium
- surface: natural anodised

Drill bush:

- material: steel
- surface: hardened and polished

**Drill jig
with setscrew**

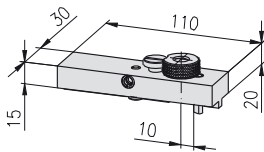

Description	Weight	Article-No.
Drill jig H with setscrew	189 g	1.99.01011
Single parts		
Weight	Article-No.	
Base body	120 g	1.99.01012-01
Drill bush for cross bushing, Ø9.2	50 g	1.99.01012-03
Safety screw for drill bush, M6×4	6 g	1.99.01012-04
Stop pin	2 g	1.99.01012-05
Connector	11 g	1.20.3/2H5

Accessories

Drill bush for parallel-anchor, Ø6.2	43 g	1.99.01012-02
--------------------------------------	------	---------------

**Drill jig
with clamping lever**

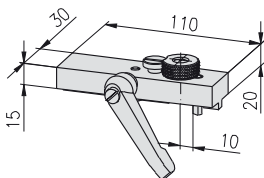

Description	Weight	Article-No.
Drill jig H with clamping lever	225 g	1.99.01012
Single parts		
Weight	Article-No.	
Base body	120 g	1.99.01012-01
Drill bush for cross bushing, Ø9.2	50 g	1.99.01012-03
Safety screw for drill bush, M6×4	6 g	1.99.01012-04
Stop pin	2 g	1.99.01012-05
Connector	11 g	1.20.3/2H5
Clamping lever 65, for connector, M6×20	36 g	1.29.650620

Accessories

Drill bush for parallel-anchor, Ø6.2	43 g	1.99.01012-02
--------------------------------------	------	---------------

Tools
for profiles with H-slots

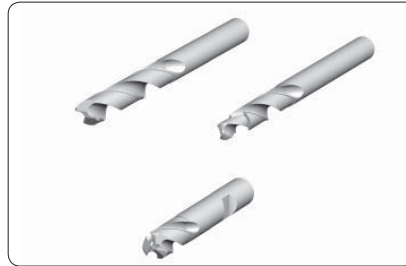

Drill, Milling cutter

Comments

Selection range ↗ 331

Milling cutter

- for • parallel-anchor
- cross bushing

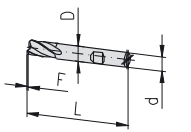

Technical data

material: HSS
3 cutting edges
cutting geometry for aluminium machining
off-centre cutting edges

Description	D	L	F	d	Weight	Article-No.
Milling cutter f. par.-anchor	Ø6.2	60	2.0×45°	8	13 g	1.99.0210645
Milling cutter f. cross bush.	Ø9.2	70	without	10	34 g	1.99.0210900
Milling cutter f. cross bush.	Ø9.2	70	1.5×45°	10	34 g	1.99.02109452

Drill

- for • parallel-anchor
- cross bushing

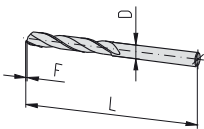

Technical data

material: HSS
2 cutting edges
cutting geometry for aluminium machining
off-centre cutting edges

Description	D	L	F	Weight	Article-No.
Drill for parallel-anchor	Ø6.2	100	2.0×45°	16 g	1.99.0310645
Drill for cross bushing	Ø9.2	120	without	43 g	1.99.03109000
Drill for cross bushing	Ø9.2	120	1.5×45°	43 g	1.99.03109452

Drill

for miter anchor

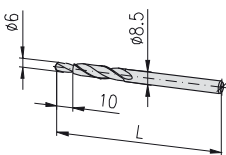

Technical data

material: HSS
2 cutting edges
cutting geometry for aluminium machining

Application

To drill core hole

Comments

Machining instruction ↗ 90, 1.2A

Description	D	L	Weight	Article-No.
Drill for miter anchor	Ø8.5	120	34 g	1.99.0310800

Drill jigs
for profiles with F- and E-slots

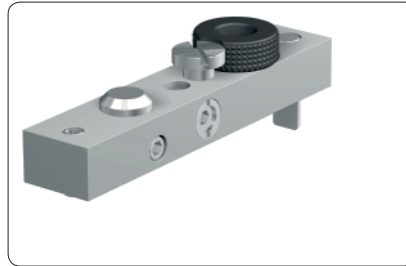

Drill jig with setscrew

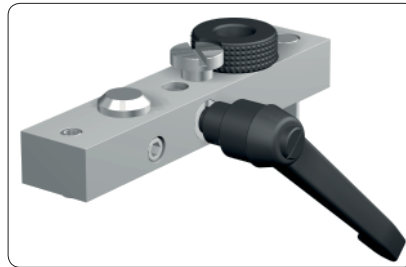

Drill jig with clamping lever

Application

Tools for precise machining of connection bore

- for drilling machine: - drill jig
- drill
- for milling machine: - milling cutter
- the drill jig is located and fastened in the profile slot
- suitable for any profile angle cut

Technical data

Base body:

- material: aluminium
- surface: natural anodised

Drill bush:

- material: steel
- surface: hardened and polished

Drill jig
with setscrew

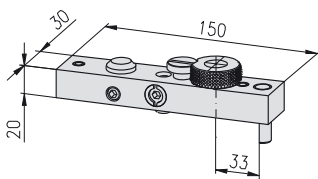

Description	Weight	Article-No.
Drill jig FE with setscrew	375 g	1.99.01111
Single parts		
Base body	188 g	1.99.01112-01
Drill bush for cross bushing, Ø15.25	105 g	1.99.01112-03
Safety screw for drill bush, M8×5.5	11 g	1.99.01112-04
Stop pin	19 g	1.99.01112-05
Setscrew for stop pin	2 g	1.99.01112-06
Connector, parallel-high	30 g	1.21.3/2F5
Anchor	20 g	1.21.A2E5

Accessories

Drill bush for parallel-anchor, Ø12.2	90 g	1.99.01112-02
---------------------------------------	------	---------------

Drill jig
with clamping lever

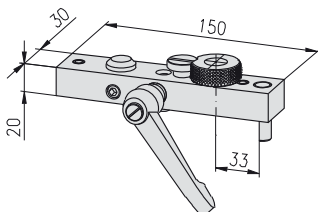

Description	Weight	Article-No.
Drill jig FE with clamping lever	438 g	1.99.01112
Single parts		
Base body	188 g	1.99.01112-01
Drill bush for cross bushing, Ø15.25	105 g	1.99.01112-03
Safety screw for drill bush, M8×5.5	11 g	1.99.01112-04
Stop pin	19 g	1.99.01112-05
Setscrew for stop pin	2 g	1.99.01112-06
Connector, parallel-high	30 g	1.21.3/2F5
Anchor	20 g	1.21.A2E5
Clamping lever 80, for connector, M10×20	63 g	1.29.801020

Accessories

Drill bush for parallel-anchor, Ø12.2	90 g	1.99.01112-02
---------------------------------------	------	---------------

Tools
for profiles with F- and E-slots

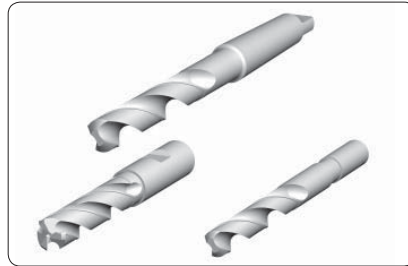

Drill, Milling cutter

Comments

Selection range ↗ 331

Milling cutter

- for • parallel-anchor
- cross bushing

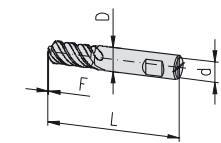

Technical data

material: HSS
3 cutting edges
cutting geometry for aluminium machining
off-centre cutting edges

Description	D	L	F	d	Weight	Article-No.
Milling cutter f. cr. bush. ST, 4	Ø12.2	83	1×45°	Ø12	60 g	1.99.02112451
Milling cutter f. cross bush. SE	Ø15.2	93	without	Ø16	116 g	1.99.02115000
Milling cutter f. cross bush.	Ø15.2	93	1.5×45°	Ø16	116 g	1.99.02115452

Drill

for parallel-anchor

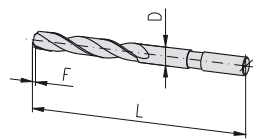

Technical data

material: HSS
2 cutting edges
cutting geometry for aluminium machining
off-centre cutting edges

Description	D	L	F	Weight	Article-No.
Drill for parallel-anchor	Ø12.2	147	2×45°	93 g	1.99.0311245

Drill

for cross bushing

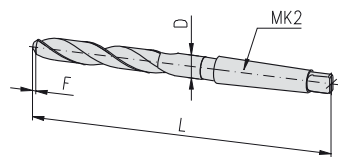

Technical data

material: HSS
2 cutting edges
cutting geometry for aluminium machining
off-centre cutting edges

Description	D	L	F	Weight	Article-No.
Drill for cross bushing, MK2	Ø15.25	210	1.5×45°	224 g	1.99.03115452

Drill

for cross bushing

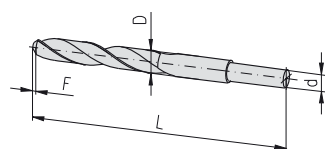

Technical data

material: HSS
2 cutting edges
cutting geometry for aluminium machining
off-centre cutting edges

Description	D	L	F	d	Weight	Article-No.
Drill for cross bushing	Ø15.25	173	1.5×45°	Ø12	197 g	1.99.03215452

Tools
for profiles with F- and E-slots

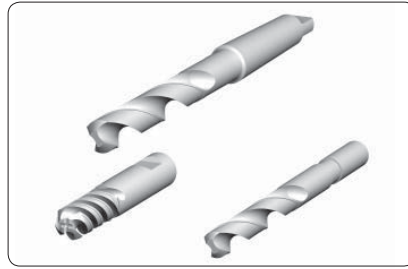

Drill, Milling cutter

Comments
Selection range 331

Milling cutter
for cross bushing

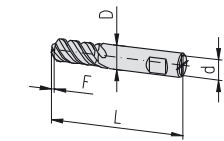

Technical data
material: HSS
4 cutting edges
cutting geometry for aluminium machining
off-centre cutting edges

Description	D	L	F	d	Weight	Article-No.
Milling cutter f. cross bush.	Ø15.2	93	4.0×45°	Ø16	116 g	1.99.02115454

Drill
for cross bushing

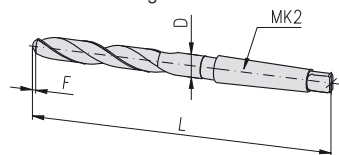

Technical data
material: HSS
2 cutting edges
cutting geometry for aluminium machining
off-centre cutting edges

Description	D	L	F	Weight	Article-No.
Drill for cross bushing, MK2	Ø15.25	210	4.0×45°	224 g	1.99.03115454

Drill
for cross bushing

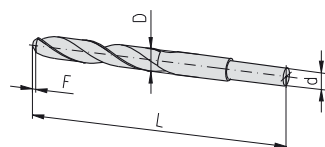

Technical data
material: HSS
2 cutting edges
cutting geometry for aluminium machining
off-centre cutting edges

Description	D	L	F	d	Weight	Article-No.
Drill for cross bushing	Ø15.25	173	4.0×45°	Ø12	197 g	1.99.03215454

**Screw taps
for aluminium machining**

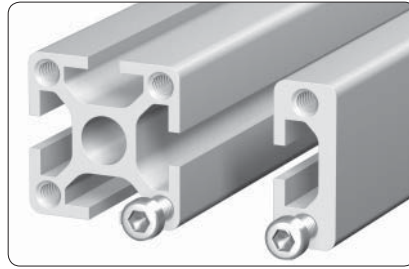

Application

Mounting threads in profile centre core hole
Ø5 mm

**Screw tap
M6**

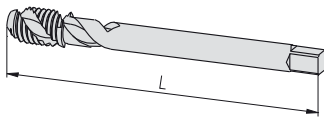

16 20 30 40 45 50 60

Technical data

- material: HSS/E
machine threading tap:
- right hand cutting, 40° right spiral fluted
 - enlarged chip flute
 - 3-pitch thread start
 - tolerance class: 6H

Description	G	L	Weight	Article-No.
Screw tap	M6	80	45 g	1.99.0406080

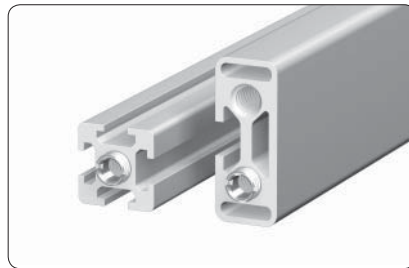

Application

Mounting threads in profile centre core hole
Ø6.2 mm

**Screw tap
M8**

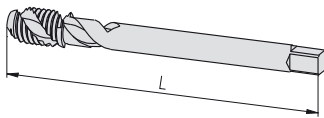

16 20 30 40 45 50 60

Technical data

- material: HSS/E
machine threading tap:
- right hand cutting, 40° right spiral fluted
 - enlarged chip flute
 - 3-pitch thread start
 - tolerance class: 6H

Description	G	L	Weight	Article-No.
Screw tap	M8	90	52 g	1.99.0408090

**Screw taps
for aluminium machining**

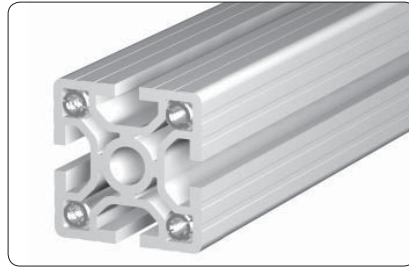

Application

Fastening thread in hollow chambers of profiles PG 50

**Screw tap
M12**

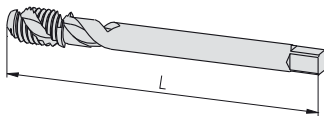

16 20 30 40 45 50 60

Technical data

material: HSS/E

machine threading tap:

- right hand cutting, 40° right spiral fluted
- enlarged chip flute
- 2-pitch thread start
- tolerance class: 6H

Description	G	L	Weight	Article-No.
Screw tap	M12	110	65 g	1.99.0412110

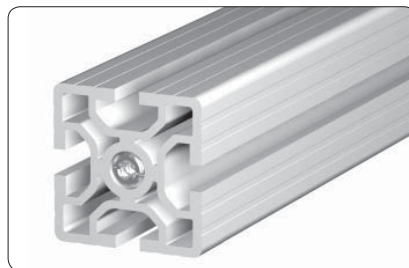

Application

Mounting threads in profile centre core hole Ø12 mm

**Screw tap
M14**

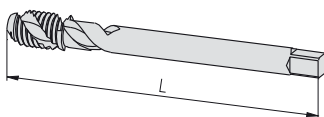

H F E

Technical data

material: HSS/E

machine threading tap:

- right hand cutting, 40° right spiral fluted
- enlarged chip flute
- 2-pitch thread start
- tolerance class: 6H

Description	G	L	Weight	Article-No.
Screw tap	M14	110	75 g	1.99.0414110
Screw tap	M14	150	105 g	1.99.0414150

A	
Abbreviations.....	5
Accessories.....	135
Acrylic.....	325
Additional accessories.....	136, 231
Adjustable tilt-feet.....	181
anti-slip discs.....	185
cushion elements.....	185
nuts.....	184
plates.....	182
Single parts.....	181
spindles.....	184
Adjustable tilt-foot anti-slip discs.....	185
Adjustable tilt-foot cushion elements.....	185
Adjustable tilt-foot nuts.....	184
Stainless steel.....	184
Steel.....	184
Adjustable tilt-foot plates.....	182
with mounting holes.....	183
without mounting holes.....	182
Adjustable tilt-foot plates with mounting holes.....	183
GD-Zn.....	183
PA.....	183
Stainless steel.....	183
Adjustable tilt-foot plates without mounting holes.....	182
GD-Zn.....	182
PA.....	182
Stainless steel.....	182
Adjustable tilt-foot spindles.....	184
Stainless steel.....	184
Steel.....	184
Alu hinges.....	249
heavy.....	251
Press-fit pins for alu hinges.....	250
Spacer.....	250
Type A.....	249
Type B.....	249
Type C.....	250
Alu hinges, heavy.....	251
Alu-plastic composite panel.....	325
Angles.....	198
Angles 25×40.....	198
Angles Alu.....	207
Angles GD-Al.....	206
Angles GD-Zn.....	200
Angles PA.....	199
Swivel angles.....	208
Angular adjusting feet.....	186
with adjusting screw.....	186
without adjusting screw.....	186
Angular tolerance.....	62
Anti-twist devices.....	131
for subsequent insertion.....	133
Approximate determination of deflection.....	63
B	
Bar locks.....	277
Assembly accessories.....	279
Lock mounting sets.....	280
Olive installation sets.....	280
Profile machining.....	278
Base angle.....	193
Base feet.....	187
Floor mounting sets.....	187, 191
Profile mounting sets.....	192
Base plates.....	210
with thread.....	211
without thread.....	211
Bayonet type connector.....	113
Bending strength.....	62
Block for cable binder.....	305
Bores for parallel-connector.....	56
Bullet catches.....	265
PA.....	266
Button head screws.....	330
C	
Cable and hose clamp.....	304
Cable binder.....	305
detachable.....	305
Calculation formulas for polygons.....	127
Carabine swivel.....	301
Castors.....	194
Fixed castors.....	194
Fixed castors with bolt hole.....	194
Fixed castors with fitting plate.....	194
Locking castors.....	196
Swivel castors.....	195
Swivel castors lockable.....	195
Swivel castors lockable with bolt hole.....	195
Swivel castors lockable with fitting plate.....	195
Swivel castors with bolt hole.....	195
Swivel castors with fitting plate.....	195
Threaded bolt for locking castor with center thread.....	197
Chipboards.....	324
Clamping connector.....	117
Clamping for guidance system.....	294
Clamping levers.....	134
Coding examples.....	58
for price group 1.....	58
for price group 2.....	59
for price group 3.....	60
Combination profiles.....	155
PVC.....	155, 158
Connection.....	131
elements.....	131
of 0-slot profiles.....	118
of MayTec with other profile systems.....	129
of profiles 40, round.....	127
plates.....	214
with corner pieces.....	219
Connection elements.....	131
Anti-twist devices.....	131
Anti-twist devices for subsequent insertion.....	133
Clamping levers.....	134
Retaining plates.....	131
Connection plates.....	214
Connection possibilities.....	118
for 0-slot profiles.....	118
for profiles 40, round.....	127
Other profile systems.....	129
Special cases.....	128
Subsequent mounting of profiles.....	128
Connection possibilities for 0-slot profiles.....	118
Connection with screw-type connector.....	125
Specification of milling patterns for closed profiles.....	119
Connection possibilities for profiles 40, round.....	127
Calculation formulas for polygons.....	127
Connection System.....	81
Connection variants with screw-type connectors.....	91, 96

Connector	89	Connector screw self-cutting	112
Bayonet type connector.....	113	Connector selection	89
Clamping connector.....	117	Connectors.....	88
Connector screw	97	Connector complete.....	101
Connector screw-self-cutting	97	Cross bushings.....	98
Cross connector	115	drill dimensions	118
Extension	90, 94	Examples	83
Extension / parallel connector.....	107	Machining of profiles with core hole-Ø6	90
Miter 90°-bent anchor l.....	95	Manufacture a connection.....	88
Miter 90°-bent anchor r.....	95	Parallel connector.....	106
Miter 90°-hinge l + r.....	90, 95	Special cases	89, 106
Miter-bent anchor l + r	95	types and materials	89
Miter-hinge l + r.....	90, 95	Connectors - Special cases	106
Oblique 90°-bent anchor	93	Bayonet type connector.....	113
Oblique 90°-bent anchor 90°	93	Clamping connector.....	117
Oblique 90°-hinge	90, 93	Connector screw self-cutting.....	112
Oblique-bent anchor l	92	Cross connector	115
Oblique-bent anchor r	93	Extension / parallel connector.....	107
Oblique-bent anchor standard l	93	Parallel connector for subsequent insertion	116
Oblique-bent anchor standard r	93	SE-Connector	109
Oblique-cross-hinge	93	ST-Connector	110
Oblique-cross-hinge 90°	93	ST-Connector with anchor, screw-type	111
Oblique-hinge l + r.....	90, 92	Universal connector with knurled cross bushing.....	108
Parallel connector for subsequent insertion	116	Corner elements	320
Parallel-cross	90, 94	Corner element 33 for wire net mounting profile 33×10	321
Parallel-high.....	90, 94	for wire net mounting profile.....	320
Parallel-high 90°	94	Corner pieces	217
Parallel-square	90, 94	45°	218
Parallel-square 90°	94	cubic	217, 220
Screw-type front sided.....	91, 96	segment	220
Screw-type parallel-cross.....	91, 96	segment, 2gang	220
Screw-type parallel-high	91, 96	spherical	218, 220
Screw-type parallel-square	91, 96	Cover caps	169
SE-Connector	109	for profiles with core hole-Ø12	171
Shifter.....	95	for profiles with core hole-Ø6	170
Square head Standard	92	for profiles without core hole	169
Square head Standard 90°	92	for screw bores	174
Square head Universal	92	for tube profile.....	169
Standard.....	92	for tubes	174
Standard 90°	92	Ø48 for hand rail profile	172
ST-Connector	110	Cover plug.....	118, 173
ST-Connector with anchor, screw-type	111	domed	173
Universal	90, 92	for connector bushings	173
Universal connector with knurled cross bushing.....	108	Cover profiles	153
Connector - Drill dimensions.....	118	Alu	153
with radius covers.....	118	PVC.....	153
without radius covers.....	118	Cross bore.....	56
Connector complete	101	Cross bushing.....	98
PG 20	101, 102, 104	bore for connector	56
PG 30	102, 104	Cross connection plates	209
PG 40	102, 104	Cross connector.....	115
PG 45	103, 105	Cross section of slots	6
PG 50	103, 105	Cross-blocks for cable binder	305
PG 60	103, 105	C-track.....	53
Connector components	101	Curved profiles	79
Anchor.....	101, 103	Cylinder locks	269
Cross bushing	101, 102	flush	271
Setscrew.....	103	with security latch.....	270
Spring.....	103	D	
Connector Cross bushings.....	98	Deflection	63
Drill dimensions for connector cross bushings	98	Delivery length.....	61
Mounting variants.....	99	Determination of deflection.....	63
Connector for.....	101	Direction and Position	57
core hole-Ø 12 mm	102	Distance washer	295
core hole-Ø 6 mm	101		

Door handle.....	276	H	
Door knob	276	Hand adjustable feet	179
Double hinge	243	Hand rail	72
Drill dimensions for connector cross bushings	98	Handle system	234
Drill jigs.....	332	oval design.....	235
for profiles with F- and E-slots.....	334	round design	234
for profiles with H-slots	332	Handles.....	231
with clamping lever.....	332, 334	light Alu	231
with setscrew	332, 334	light PA	231
Drills	333, 335	PA	232
E		PA with bore.....	232
E3-slot	6	PA with thread.....	232
E4-slot.....	6	Hanging bracket	300
Eco-Slides	296	Hinges.....	237, 242, 244
Edge roller.....	289	Alu hinges.....	249
Electrical accessories	137, 302	Alu hinges, heavy	251
accessories.....	316	Double hinge.....	243
E-trunking, end plates	318	Lift-off hinges.....	238
E-trunking, for clips	319	I	
Electrical installation trunking.....	316	Installation accessories.....	135, 153
E-trunking lids.....	48	Installation rings.....	306
E-trunking profile.....	48	J	
E-trunking, end plates	318	Joints.....	253
E-trunking, for clips	319	with / without clamping lever.....	255
E-trunking profiles.....	48	with clamping lever.....	253
Base profiles	48	without clamping lever	253
Cover profiles	48	Zn	255
Extension / parallel connector	107	Zn, with clamping lever	255
Extruded profile as per DIN EN 12020	61	Zn, without clamping lever	255
Eye-bolt.....	216	L	
F		Latch lock	281
Fastening elements.....	135	Levelling feet	178, 180
Fastening plate 30×150.....	215	Levelling furniture foot.....	180
Fixed castors	194	Lift-off hinges	238
with bolt hole.....	194	Lock GD-Zn	268
with fitting plate.....	194	Lock mounting set	280
Flap-lock countersunk.....	271	with double beard key.....	280
Flatness of profile surfaces	61	with square key	280
Flatness tolerance.....	61	Locking castors	196
Flexure load.....	130	with center thread	197
Floor levelling screw.....	178	with plate.....	196
Floor mounting plate	212	M	
Floor plate	213	Machining of profiles.....	90
Frame guide	291	with core hole-Ø6.....	90
Framing profiles.....	160, 165	with core hole-Ø6 for miter	90
one piece	160	Magnetic lock PA	267
two pieces	165	Makrolon	326
F-slot	6	MayTec connector with square head	83
Functional length	61	MayTec ground-connector for potential equilisation	83
G		MayTec screw-type connector	83
Grab handle profiles	52, 236	MayTec standard-connector	83
Grab handles	236	MayTec universal-connector	83
Grid, steel.....	327	Mechanical data	61
Ground connections	303	Milling cutter	333, 335
Ground connector for potential equilisation	302	Mortise deadlocks.....	273
Guard locking device.....	309	cases.....	274
Guidance system	293	cases with lock.....	275
Clamping for guidance system.....	294	cases without lock.....	274
Distance washer.....	295	Door handle	276
Sliding blocks.....	294	Door knob	276
T-Nut sliding blocks	295	Installation sets	274
Guide profile PVC.....	159		

Installation sets with lock	275
Installation sets without lock.....	274
Profile machining.....	273
Push pins.....	276
Mounting adaptor for roller	288
Mounting blocks	256
Distancing plate, thin	259
for subsequent insertion.....	258
GD-Zn.....	257
screw-type.....	256
Mounting clamp blocks	260
for subsequent insertion.....	260
SL	262
Tool for mounting clamp block SL.....	262
Mounting instruction for screw-type connectors.....	91, 96
Mounting of connector in core hole	84
Mounting of connector in slot.....	85
Mounting plates.....	213
Mounting set for 19" profile.....	307
Mounting sockets.....	322

N

Numerical key for articles	7
----------------------------------	---

O

Olive installation sets.....	280
Order description	54
Order examples for special design	60
Oval tube.....	235

P

Panel elements.....	137, 320, 323
Acrylic	325
Alu-plastic composite panel	325
Chipboards.....	324
Grid, steel	327
Makrolon.....	326
Polycarbonate	326
Solid plastic panels.....	324
Wire net, Alu	326
Wire net, steel.....	327
Panel profiles.....	44
Panel profiles 30, F-slot, P	44
Panel profiles 40, E3-slot, P	45
Panel profiles 50, E4-slot, P	46
Parallel connector	106
Parallel connector for subsequent insertion.....	116
Parallelism tolerance.....	62
Pneumatic	221
90° connection sets	229
accessories.....	221
connection plate sets.....	227
connection plates	227
end plate sets.....	222
end plates.....	222
extension sets	228
Pneumatic accessories.....	136, 221, 230
Blanking plug	230
Reducing nipple.....	230
Sealing ring.....	230
Polycarbonate.....	326
Potential equalisation	302
Press in device for knurled cross bushing.....	330
Press-fit pins for alu hinges	250
Press-fit threaded inserts	151
without collar.....	152

Price groups (1 -3).....	55
Profile applications.....	68
Curved profiles	79
Hand rail	72
Profile combinations	68
Profiles for cable guide	75
Slot plates.....	69
Special slits.....	68
U-Profile 40	74
Profile combinations.....	68
Profile group.....	12
16 mm, E3-slot, P	12
16 mm, F-slot, P	12
20 mm, F-slot, P	15
20 mm, H-slot, P	13
30 mm, E4-slot, P	18
30 mm, F-slot	34
30 mm, F-slot, P	16
40 mm, E3-slot	36
40 mm, E3-slot, P	20
45 mm, E4-slot	39
45 mm, E4-slot, P	28
50 mm, E4-slot	40
50 mm, E4-slot, P	31
60 mm, E4-slot	42
60 mm, E4-slot, P	32
Profile machining	54
Bores for parallel-connector	56
Coding examples	58
Coding examples for special design	60
Cross bore	56
Cross bushing bore for connector	56
Direction and Position	57
Order description.....	54
Price group 1-3.....	55
Saw cut	55
Saw cut tolerance.....	55
Summary	54
Thread.....	56
lid 30.....	76
lid 40.....	77
lid 50.....	78
Profile pre-cut lids.....	52
Profile selection range.....	64
Profile tolerance.....	61
Profiles 48, round (plain)	43
Profiles for cable guide.....	75
Slot distance 30	76
Slot distance 40	77
Slot distance 50	78
Profiles for pneumatic applications.....	221
Profiles octagonal (plain).....	43
Push pins	276

Q

Quick locks.....	263
------------------	-----

R

Radius compensations	177
Radius covers	175
Rectangle 90° with one radius	176
Rectangle 90° with two radii	176
Rectangle with one radius	175
Rectangle with two radii	176
Square with one radius	175
Square with two radii	176

Reducing profiles PVC	154	Solid plastic panels	324
Register	1	Spacer	250
Retaining plates	131	Special cases	89
Rhomboid T-slot nuts	147	Special characters	5
Roller 29	283	Special slits	68
Roller 39	282	Specification of milling patterns for closed profiles	119
Roller fastening sets	284	Sponge rubber round cords	162
A, double sided	285	Spring-nuts	145
A, one sided	285	Stacking foot	193
type A	284	ST-Connector	110
type B	286	with anchor, screw-type	111
Rubber cover-profiles	168	Stopper Type 1 for sliding suspended doors	291
Rubber door stop	291	Stopper Type 2 for sliding suspended doors	291
Runner	290	Straightness tolerance	61
for sliding suspended doors	290	Strength values for profile connections	130
for suspended doors	290	with MayTec-Connectors	130
S		Subsequent mounting of profiles	128
Safety interlocking	310	Summary	8, 84, 135, 331
Contact bracket-mounting	311	Accessories	135
mountings	310	Connectors (with machining)	84
Safety interlocking-mountings	310	Connectors (without machining)	86
AZ 17 for sliding door	313	Profiles (plain)	8
AZ 17 for swinging door	312	Profiles (with grooves)	9
for sliding door	311	Tools	331
for swinging door	310	Suspended doors	290
with lock for swinging door	310	Alu C-track	290
Safety switches	308	Runner	290
AZ 17	309	Suspended glider	301
Contact bracket-mounting	311	Swivel angles	208
Guard locking devices AZM 170	309	Swivel castors	195
Saw cut	55	Swivel castors lockable	195
Saw cut tolerance	55	Symbols	5
Screw taps	338	T	
Screw taps for aluminium machining	338	Table of contents	3
Screws	330	T-Bolts	148
Button head screws	330	Technical data	61
Sealing profile	164	Angular tolerance	62
SE-Connector	109	Approximate determination of deflection	63
Security latch	270	Bending strength	62
Self locking washers	328	Deflection	63
SP	329	Delivery length	61
Standard	329	Extruded profile as per EN 12020	61
Sensor brackets	315	Flatness of profile surfaces	61
Slide load	130	Flatness tolerance	61
Sliding blocks	294	Functional length	61
Sliding doors	157	Mechanical data	61
construction types	157	Parallelism tolerance	62
Sliding profiles	53	Profile tolerance	61
Slot plates	69	Straightness tolerance	61
E-slot	69	Twist tolerance	61
E-slot, slot distance 25 mm	71	Tension load	130
E-slot, slot distance 50 mm	71	Thread	56
F-slot	69	Threaded bolt for locking castor with center thread	197
F-slot, slot distance 25 mm	70	Threaded inserts	149
F-slot, slot distance 50 mm	70	Press-fit threaded inserts	151
Profile 30×100, 10F, SP	70	Press-fit threaded inserts w/o collar	152
Profile 30×100, 5E, 2F, SP	71	Threaded plates	138
Profile 30×150, 8E, SP	71	for subsequent insertion	139
Profile 30×150, 8F, SP	70	heavy	140
Slot rollers	292	T-Nut sliding blocks	295
Slot system	6	T-Nuts	141
E3-slot	6	for subsequent insertion	142
E4-slot	6	for subsequent insertion, with spring	143
F-slot	6	for subsequent insertion, with spring ball	142
H-slot	6	for subsequent insertion, with spring, 2×M4	144

for subsequent insertion, with spring, 2×M8	143
with spring	141
Tools	137, 331
Drill	333, 335
Drill jigs	332, 334
for anchors.....	331
for cross bushings	331
for profiles with F- and E-slots.....	335
for profiles with H-slots	333
Milling cutter	333, 335
Press in device for knurled cross bushings	330
Screw taps.....	338
Special cases	337
Summary	331
Tx screw driver	330
Torque tightening values for connector setscrew	130
Torx	330
T-slot nuts	146
Tube profiles.....	51
Tube profiles 30, P.....	51
Tubes	51
Twin track guide for roller 29	283
Twist tolerance.....	61
Tx screw driver	330
Type of load.....	62
 U	
Universal connector.....	90, 92
for profile 30×150.....	106
with knurled cross bushing.....	108
U-Profile 40.....	74
U-Profiles	53
 V	
Vibration proof	81
 W	
Washers	328
Wedge profiles.....	161
Wire net mounting profiles	52
Wire net profiles	47
30, F-slot, P	47
40, F / E3-slot, P	47
Wire net, Alu.....	326
Wire net, steel	327

Imprint

Subject to technical modification.

All rights reserved.

Copying - also in parts - only allowed by written consent.

© MayTec Aluminium Systemtechnik GmbH,
Germany, D - 85221 Dachau, 2014



MayTec GmbH plant in Dachau



Small parts storage



Stock of aluminium profiles

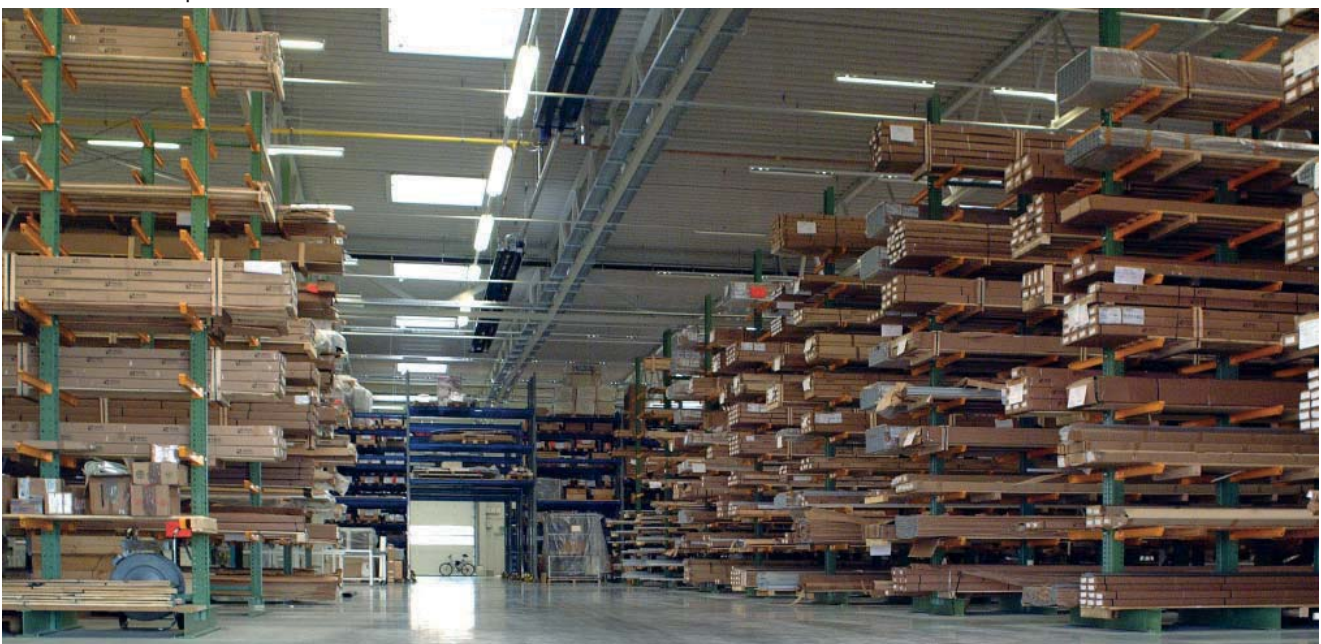

The key ...

to success

extremely strong

efficient

functional

Australia

MayTec Australia P/L

Unit 8, 175 James Ruse Drive
Rosehill, NSW 2142

country code: +61
phone (0)2/9898 9929
fax (0)2/9638 4086
e-mail: info@maytec.com.au
<http://www.maytec.com.au>

Germany

MayTec Aluminium
Systemtechnik GmbH
Kopernikusstraße 20
D-85221 Dachau

country code: +49
phone (0)8131/3336-0
fax (0)8131/3336-119
e-mail: mail@maytec.de
<http://www.maytec.de>

USA

MayTec Inc.

901 Wesemann Drive
West Dundee, IL 60118

country code: +1
phone 847-429-0321
fax 847-429-0460
e-mail: mail@maytecinc.com
<http://www.maytecinc.com>

MayTec distributor